



# CLOCK PARTS BRANDED

## CLOCK PARTS BRANDED

ANGELUS



Angelus Movement Parts 211 items listed on website

BAYARD



Bayard Movement Parts 4 items listed on website

BLESSING



Blessing Movement Parts 3 items listed on website

CYMA,  
TAVANNES



Cyma Clock Movement Parts 77 items listed on website

EUROPA



Europa Movement Parts 74 items listed on website

HELVECO,  
IMHOF



Helveco, Imhof Movement Parts 171 items listed on website

JAEGER LE  
COULTRE, JLC



JLC Clock Movement Parts 10 items listed on website

KERN



Kern Movement Parts 4 items listed on website

KIENINGER



Kieninger Movement Parts 9 items listed on website

KIENZLE



Kienzle Clock Movement Parts 69 items listed on website

KUNDO



Kundo Movement Parts 3 items listed on website

LOOPING



Looping Movement Parts 144 items listed on website

LUXOR



Luxor Movement Parts 4 items listed on website

MAUTHE



Mauthe Movement Parts 5 items listed on website

ORIS



Oris Clock Movement Parts 101 items listed on website

PETER



Peter Movement Parts 2 items listed on website

SCHATZ



Schatz Movement Parts 39 items listed on website

SWIZA



Swiza Movement Parts 162 items listed on website

WEHRLE



Wehrle Movement Parts 1 items listed on website

WESTCLOX



Westclox Movement Parts 1 items listed on website

## Clock Movements

See Page: 1292

## Clock Movements

See Page: 1313



## Clock Movements

See Page: 1316



## Clock Movements

See Page: 1318



# CLOCK MOVEMENTS & PARTS

## BELLS, STANDS & HAMMERS

### Brass (Cast) Bells

Clock Bells - Cast

Ideal for small to medium clock, Indian made for economy clocks

- Brass
- Drilled Pilot Hole
- Polished finish
- Ø50, 60, 90 & 130mm



Dimensions\*: Diameter x Height

Dimensions are approximate and can be up to + 5mm

Code	Description	UOM	Price
B31285	Ø50mm x 16mm Bell	EACH	£4.75
B31286	Ø60mm x 20mm Bell	EACH	£4.95
B37842	Ø95mm x 34mm Bell	EACH	£6.75
B39694	Ø135mm x 50mm Bell	EACH	£7.95

### Brass (Hermle) Bells



Hermle Bells (Glocke C)

- Hermle bells supplied by size
- Sizes: Ø32, 36, 46, 51, 60 & 65mm

Dimensions: Diameter x Height

Code	Description	UOM	Price
H46255	Ø32mm x 12mm Bell (E002.039604)	EACH	£10.95
H46256	Ø36mm x 15mm Bell (E002.039504)	EACH	£10.95
HER26732	Ø46mm x 20mm Bell (E002.039404)	EACH	£10.95
HER26733	Ø51mm x 20mm Bell (E002.039304)	EACH	£11.95
H46257	Ø60mm x 20mm Bell (E002.039204)	EACH	£12.50
H46258	Ø65mm x 20mm Bell (E002.039104)	EACH	£12.95

### Brass (Pressed) Bells



Clock Bells - Pressed

Ideal for small to medium clock, french strikers and carriage clocks etc. Quality bells for quality clocks

- Brass
- Pre Formed Square
- Polished finish
- From Ø32 to 70mm
- Made in Germany

Dimensions: Diameter x Height (approx.)

Code	Description	UOM	Price
B0068	Ø32mm x 13mm Bell	EACH	£8.85
B0070	Ø42mm x 17mm Bell	EACH	£16.55
B0071	Ø46mm x 15mm Bell	EACH	£17.15
B0072	Ø51mm x 16mm Bell	EACH	£17.85
B0073	Ø60mm x 20mm Bell	EACH	£22.95
B0074	Ø65mm x 20mm Bell	EACH	£23.95
B0075	Ø70mm x 25mm Bell	EACH	£24.95

### Bronze (Cast) Bells



Clock Bells - Cast - Bronze

Ideal for Longcase & larger clocks. Top quality bronze cast bells.

- Bronze
- Pre Formed Hole
- Sand Blasted Finish
- Ø85mm to Ø140mm
- Made in Germany

Dimensions: Diameter x Height (approx.)

Code	Description	UOM	Price
B33568	Ø85 x 32mm Bell	EACH	£19.95
B0064	Ø100 x 38mm Bell	EACH	£25.95
B0065	Ø120 x 44mm Bell	EACH	£34.95
B0066	Ø130 x 48mm Bell	EACH	£39.95
B0067	Ø140 x 52mm Bell	EACH	£43.95

### Steel (Black) Bells

Clock Bells - Steel - Matt Black Finish

Ideal for Longcase & larger clocks. Good quality steel bell

- Steel with Matt Black Finish
- Pre Formed Hole
- Ø140mm

Dimensions: Diameter x Height (approx.)

Code	Description	UOM	Price
B0078	Ø140mm x 47mm Bell	EACH	£47.75



### Steel (Pressed) Bells



Clock Bells - Pressed

Ideal for small to medium clock, Indian made for economy clocks

- Steel
- Drilled Pilot Hole
- Polished finish
- Ø80 & 100mm

Dimensions: Diameter x Height (approx.)

Code	Description	UOM	Price
B36940	Ø80mm x 20mm Bell	EACH	£3.95
B36939	Ø100mm x 37mm Bell	EACH	£3.95
B37843	Ø120mm x 41mm Bell	EACH	£6.95

### Bell Hammer, French Clock



French Clock (FC) - Bell / Gong Hammers

- UK Made & Indian made
- Brass
- Turned brass, leather or nylon head
- Brass wire shaft
- Overall length 65mm (approx.)

Code	Description	UOM	Price
F6230	Bell Hammer (FC) Made in UK	EACH	£8.95
F31289	Bell Hammer (FC) Made in India	EACH	£1.80
F31288	Bell Hammer (FC) Nylon Head	EACH	£1.80
F6231	Bell Hammer (FC) Leather Head	EACH	£9.25

### Bell Hammer, Longcase



Longcase Bell Hammer

Has a 2.25mm steel shaft, that can be easily formed into the required profile. The Bell Hammer requires only a small amount of finishing before final fitting to the movement being worked on. Total length (centre of mounting hole to the centre of the hammer head) 93mm.

- Steel
- 2.25mm Shaft
- Length 93mm (hole centre to hammer head centre)

Code	Description	UOM	Price
L0903	Long Case Bell Hammer	EACH	£6.75

### Bell Hammer Arm & Collet



Bell Hammer Arm & Collet

- Solid brass hammer wire with collet for wall mounted clocks
- Ø1.40mm
- Total length 77mm (approx.)
- Collet hole Ø2.80mm

Code	Description	UOM	Price
H7787	Bell Hammer Arm & Collet	EACH	£4.95

### Bell Hammer Head

Bell - Hammer Head



- Solid Brass
- With nylon insert
- Cross bore and clamp screw
- Size: 6.5 x 8 x 16mm

Code	Description	UOM	Price
H7785	Gong Hammer Head	EACH	£5.95

### Bell Hammer Spring & Screw, Longcase



Long Case Clock - Bell Hammer Spring & Screw

Composite Bell Hammer Spring supplied with a 4BA screw. Total length (from the tip of the spring to the centre of the mounting hole) 118.5mm

- Steel
- Screw (4BA)
- Length 118.5mm (overall)
- Made in UK

Code	Description	UOM	Price
L0904	Bell Hammer Spring & Screw	EACH	£9.55

### Bell Stand, English Dial



English Dial, Fusee - Bell Stand

- Composite fusee bell stand
- 3.0mm mounting for bell
- Square brass nut
- 82.75mm between screw hole & bell seat

Code	Description	UOM	Price
P34569	English Dial, Fusee Bell Stand	EACH	£12.10

### Bell Stand & Nut, French Clock

French Clock Bell Stand & Nut



- Brass
- Brass knurled fixing nut
- Shaft length 44.5mm
- UK or Indian Made

Code	Description	UOM	Price
F4894	Bell Stand & Nut, Made in UK	EACH	£10.25
F31284	Bell Stand & Nut, Made in India	EACH	£1.80

### Bell Stand Nut, French Clock

French Clock - Nut for French Bell Stand



Knurled nut blank for locking French clock bell to bellstand. Turned profile with pilot hole, ready for tapping.

- Brass
- (Untapped) Turned brass
- Tap out to suit your job
- Made in UK

Code	Description	UOM	Price
F8912	Nut for French Bell Stand	EACH	£0.95

### Bell Stand & Nut, Longcase



Long Case Clock - Bell Stand & Nut

A very high quality steel Bell Stand for Longcase thirty hour & eight day clocks. Forged in one piece with a drilled foot & tapered shank & supplied with square brass locking nut to secure the bell. The total length from fixing hole to the bell seat is 105mm.

- Steel Round Post
- Brass Securing Nut
- Length 105mm (fixing hole to bell seat)
- Made in UK

Code	Description	UOM	Price
L0905	Long Case Bell Stand & Nut	EACH	£12.95

## BEZELS & DIAL PANS

### Dial Pans



Dial Pans

- Aluminium
- Various sizes available
- With hand shaft hole
- 8mm recess depth (approximate)
- Size given is outside diameter
- 0.50mm thick sheet (approximate)

Code	Description	UOM	Price
D46038	Ø135mm Dial Pan	EACH	£2.95

D46039	Ø160mm Dial Pan	EACH	£3.25
D46040	Ø170mm Dial Pan	EACH	£3.50
D46041	Ø180mm Dial Pan	EACH	£3.75
D46042	Ø200mm Dial Pan	EACH	£3.95

### Ansonia Bezels



Ansonia Clock Bezel - Brass

Specifically shaped spun brass rim for Ansonia application. Does not use inner ring, with glass traditionally held by plaster of paris or similar.

- Spun Brass
- Hinged
- Excludes Glass
- Ø13" measured at outer edge
- Aperture = Ø11 7/8"

Dimensions: outer total diameter x actual aperture.

Code	Description	UOM	Price
B0084	13" Bezel (13" x 11 7/8")	EACH	£69.95

### Barometer Bezels



Barometer Bezels - Brass

- Spun Brass
- Pin On
- Excludes Glass
- 8" or 10"

Dimensions: outer total diameter x actual aperture.

Code	Description	UOM	Price
B4736	8" Bezel (8 3/4" x 7 3/4")	EACH	£20.95
B4737	10" Bezel (10 1/2" x 9 3/8")	EACH	£31.50

### Spun Brass Bezels with Ring



Clock Bezels - Brass

Suitable bezel replacement for fusee / English dial clocks. Includes a silvered inner retaining ring & the brass bezel is hinged and tabbed.

# BUSHES (CLOCK)

- Spun Brass
- Hinged and Tabbed
- Excludes Glass
- 8" to 18"
- Glass is held in place with the aluminium retaining ring
- Larger bezels may require some adhesive/putty to allow the retaining ring to hold the glass securely
- Made in UK

Dimensions: outer total diameter x actual aperture.

Code	Description	UOM	Price
B0083	8" Bezel (8 3/8" x 7 3/4")	EACH	£27.95
B0082	10" Bezel (10 1/2" x 9 3/8")	EACH	£33.50
B0081	12" Bezel (12 3/8" x 11 3/16")	EACH	£35.95
B0080	14" Bezel (14 1/2" x 13 1/8")	EACH	£43.95
B0079	16" Bezel (16 7/8" x 15")	EACH	£55.95
B2828	18" Bezel (19 1/2" x 17 3/4")	EACH	£79.95

## Brass Bezels



Brass Bezels

- Brass plated iron
- Clock bezels
- Various sizes available
- Recess depth 10mm (approximate)

Dimensions (approximate):

- Outer diameter x inner diameter

Code	Description	UOM	Price
B46032	Ø135 x Ø123mm Bezel	EACH	£6.95
B46033	Ø160 x Ø147mm Bezel	EACH	£7.95
B46034	Ø170 x Ø157mm Bezel	EACH	£8.95
B46035	Ø180 x Ø167mm Bezel	EACH	£8.95
B46036	Ø200 x Ø186mm Bezel	EACH	£9.95
B46037	Ø220 x Ø196mm Bezel	EACH	£10.95

## Chrome Bezels with Glass, Hinged



Clock Bezels - Chrome with Glass

- Chrome bezel & glass only, with fittings
- Hinged
- Fixing via two threaded rods and nuts through the case
- Measured at outer bezel edge
- Made in Germany

Dimensions: outer total diameter

Code	Description	UOM	Price
B9281	Ø147mm Bezel & Glass	EACH	£16.95
B9283	Ø172mm Bezel & Glass	EACH	£17.95
B9284	Ø180mm Bezel & Glass	EACH	£18.95

## Convex Clock Glasses

See Page 1253



## Postman's Alarm Bezels



Postman's Alarm Clock Bezels - Brass

Does not use inner ring and glass is not included.

- Spun Brass
- Hinged & Tabbed
- Excludes Glass
- Outer Ø 9 1/4"
- Aperture 8 7/16"

Dimensions: outer total diameter x actual aperture.

Code	Description	UOM	Price
B0085	9 1/4" Bezel (9 1/4" x 8 7/16")	EACH	£57.95

## Sessions Bezels



Sessions Mantel Clock Bezels - Brass

- Brass
- Excludes glass
- May require final finishing
- Ø140 x Ø130 x 12mm

Dimensions (approx.):

- Outer diameter x aperture diameter x depth

Code	Description	UOM	Price
B32039	Ø140mm Sessions Bezel	EACH	£2.95

## Vienna Bezels, Inner Ring



Vienna Regulator Inner Bezels - Brass

- Spun Brass
- Excludes Glass
- Patterned Textured Edge
- 3 1/2" or 4" Outer Diameter

Dimensions: outer total diameter x actual aperture.

Code	Description	UOM	Price
B2829	3 1/2" Bezel (3 1/2" x 2 7/8")	EACH	£6.95
B2830	4" Bezel (4" x 3 7/16")	EACH	£8.95

## Vienna Bezels, Outer Ring



Vienna Regulator Outer Bezels - Brass

- Straight wall to fit round dial
- Spun Brass
- Excludes Glass
- Patterned Textured Edge
- 7" or 8" Outer Diameter

Dimensions: outer total diameter x actual aperture.

Code	Description	UOM	Price
B2826	7" Bezel (7 1/4" x 6 3/16")	EACH	£24.15
B2827	8" Bezel (8 1/8" x 7")	EACH	£25.25

# BUSHES (CLOCK)

## ASSORTED CLOCK BUSHES

### Assorted Clock Bushes



Clock Bushes - General Assortment

- Brass
- Various Sizes
- 100 pieces

Code	Description	UOM	Price
A32030	Clock Bush Assortment	PACK*100	£5.50

# BUSHING RODS

### Hollow Bushing Rods

Clock Bush Rods - Hollow - Pre Drilled

Plugs the worn pivot hole with a pre-drilled rod for final finishing and broaching to suit.

- Brass wire
- Hollow pre-drilled rods
- 5 pieces per size per pack
- 80mm lengths
- Outside Ø2mm, 2.5mm & 3mm
- Hole Ø0.55mm, 0.65mm & 1.00mm



Code	Description	UOM	Price
B13714	Ø2.0mm (Ø0.55mm bore) Rod	PACK*5	£2.95

<b>B13715</b>	Ø2.5mm (Ø0.65mm bore) Rod	PACK*5	<b>£2.95</b>
<b>B13716</b>	Ø3.0mm (Ø1.00mm bore) Rod	PACK*5	<b>£2.95</b>

### Solid Bushing Rods



#### Clock Bush Rods - Solid

Plugs the worn pivot hole ready for drilling and broaching to suit.

- Brass wire
- Solid plugging wire
- 23 pieces
- 150mm lengths
- Assorted sizes Ø0.40mm to Ø4.00mm in diameter (approx.)

Code	Description	UOM	Price
<b>B9731</b>	Bushing Rods, Solid	PACK*23	<b>£3.30</b>

## ENGLISH BUSHES

### English Clock Bushes



#### English Clock Bushes

Specially manufactured Brass Bushes for English Clocks etc. available in 6 sizes covering all combinations of repair jobs. Ideal for thicker movement plates, will broach and smooth out as required. Sizes in mm.

- Traditional taper fit
- Ideal for thicker movement plates
- Made in UK
- All sizes Per 10 pieces per pack

Dimensions: Hole Ø x (tapered outside diameters)

- A = Hole Ø
- B = All Height 4mm
- C = Outside Ø widest point
- D = Outside Ø Narrowest point

Code	Description	UOM	Price
<b>B6271</b>	Ø0.80mm (2.10 x 2.20mm)	PACK*10	<b>£2.60</b>
<b>B6272</b>	Ø0.90mm (2.50 x 2.60mm)	PACK*10	<b>£2.60</b>
<b>B6273</b>	Ø0.90mm (2.90 x 3.00mm)	PACK*10	<b>£2.60</b>
<b>B6274</b>	Ø1.00mm (3.30 x 3.40mm)	PACK*10	<b>£2.60</b>
<b>B6275</b>	Ø1.10mm (3.70 x 3.80mm)	PACK*10	<b>£2.60</b>
<b>B6276</b>	Ø1.10mm (4.10 x 4.20mm)	PACK*10	<b>£2.60</b>

Price breaks available, see website

## FRENCH (& MANTEL) BUSHES

### Small, French Clock

Small Size French Clock Bushes - with Holding Shaft

Available in a graded box set or individually by size in packs of 10 pieces.



- For small size French clocks
- Set (220) contains 10 sizes
- 10 of each size (100 pieces)
- Hole sizes included: Ø0.12, 0.14, 0.16, 0.18, 0.20, 0.22, 0.24, 0.26, 0.28, 0.30mm

Dimensions (approximate):

- Hole size x external diameter (widest point) x height

Code	Description	UOM	Price
<b>B5005</b>	Small French Clock Bush Set	PACK*100	<b>£13.95</b>
<b>B4964</b>	Ø0.12 x 1.00 x 6.20mm Bushes	PACK*10	<b>£1.65</b>
<b>B4965</b>	Ø0.14 x 1.00 x 6.20mm Bushes	PACK*10	<b>£1.65</b>
<b>B4965AA</b>	Ø0.16 x 1.00 x 6.20mm Bushes	PACK*10	<b>£1.65</b>
<b>B4966</b>	Ø0.18 x 1.00 x 6.20mm Bushes	PACK*10	<b>£1.65</b>
<b>B4967</b>	Ø0.20 x 1.00 x 6.20mm Bushes	PACK*10	<b>£1.65</b>
<b>B4968</b>	Ø0.22 x 1.00 x 6.20mm Bushes	PACK*10	<b>£1.65</b>
<b>B4969</b>	Ø0.24 x 1.00 x 6.20mm Bushes	PACK*10	<b>£1.65</b>
<b>B4970</b>	Ø0.26 x 1.00 x 6.20mm Bushes	PACK*10	<b>£1.65</b>
<b>B4971</b>	Ø0.28 x 1.00 x 6.20mm Bushes	PACK*10	<b>£1.65</b>
<b>B4972</b>	Ø0.30 x 1.00 x 6.20mm Bushes	PACK*10	<b>£1.65</b>

### Medium, French Clock

Medium Size French Clock Bushes - with Holding Shaft

Available in a graded box set or individually by size in packs of 10 pieces.

- For medium size French clocks
- Set (252 contains 10 sizes)
- 10 of each size (100 pieces)
- Hole sizes included: Ø0.36, 0.38, 0.40, 0.42, 0.44, 0.46, 0.48, 0.50, 0.52, 0.55mm

Dimensions (approximate):

- Hole size x external diameter (widest point) x height

Code	Description	UOM	Price
<b>B5006</b>	Medium French Clock Bush Set	PACK*100	<b>£12.95</b>
<b>B4973</b>	Ø0.36 x 1.40 x 7.05mm Bushes	PACK*10	<b>£1.50</b>
<b>B4974</b>	Ø0.38 x 1.40 x 7.00mm Bushes	PACK*10	<b>£1.50</b>
<b>B4975</b>	Ø0.40 x 1.40 x 7.00mm Bushes	PACK*10	<b>£1.50</b>
<b>B4976</b>	Ø0.42 x 1.40 x 7.00mm Bushes	PACK*10	<b>£1.50</b>
<b>B4977</b>	Ø0.44 x 1.40 x 7.00mm Bushes	PACK*10	<b>£1.50</b>
<b>B4978</b>	Ø0.46 x 1.70 x 7.50mm Bushes	PACK*10	<b>£1.50</b>
<b>B4979</b>	Ø0.48 x 1.70 x 8.50mm Bushes	PACK*10	<b>£1.50</b>
<b>B4980</b>	Ø0.50 x 1.70 x 9.00mm Bushes	PACK*10	<b>£1.50</b>
<b>B4981</b>	Ø0.52 x 1.70 x 9.00mm Bushes	PACK*10	<b>£1.50</b>
<b>B4982</b>	Ø0.55 x 1.70 x 9.00mm Bushes	PACK*10	<b>£1.50</b>

### Large, French Clock

Large Size French Clock Bushes - with Holding Shaft

Available in a graded box set.

- For larger size French clocks
- Set 253 contains 10 sizes
- 10 of each size (100 pieces)
- Hole sizes included: Ø0.46, 0.48, 0.50, 0.52, 0.55, 0.58, 0.61, 0.64, 0.67, 0.70mm

Dimensions (approximate):

- Hole size x external diameter (widest point) x height

Code	Description	UOM	Price
<b>B19388</b>	Large French Clock Bush Set	PACK*100	<b>£13.50</b>
<b>B37728</b>	Ø0.46 x 1.70 x 7.50mm Bushes	PACK*10	<b>£1.75</b>
<b>B37729</b>	Ø0.48 x 1.70 x 8.50mm Bushes	PACK*10	<b>£1.75</b>
<b>B37730</b>	Ø0.50 x 1.70 x 9.00mm Bushes	PACK*10	<b>£1.75</b>
<b>B37731</b>	Ø0.52 x 1.70 x 9.00mm Bushes	PACK*10	<b>£1.75</b>
<b>B37732</b>	Ø0.55 x 1.80 x 9.00mm Bushes	PACK*10	<b>£1.75</b>
<b>B37733</b>	Ø0.58 x 1.80 x 9.00mm Bushes	PACK*10	<b>£1.75</b>
<b>B37734</b>	Ø0.61 x 1.80 x 9.00mm Bushes	PACK*10	<b>£1.75</b>
<b>B37735</b>	Ø0.64 x 1.90 x 9.00mm Bushes	PACK*10	<b>£1.75</b>

<b>B37736</b>	Ø0.67 x 1.90 x 9.00mm Bushes	PACK*10	<b>£1.75</b>
<b>B37737</b>	Ø0.70 x 1.90 x 9.00mm Bushes	PACK*10	<b>£1.75</b>

### Mantel Clock, General

Mantel Clock Bushes - General

Available in a graded box set or individually by size in packs of 10 pieces.



- For general size mantel clock
- Set (255) contains 12 sizes
- 10 of each size (120 pieces)
- Hole sizes included: Ø0.25, 0.40, 0.50, 0.60, 0.70, 0.80, 0.90, 1.00, 1.25, 1.50, 1.75, 2.00mm

Dimensions (approximate):

- Hole size x external diameter x height

Code	Description	UOM	Price
<b>B5008</b>	General Mantel Clock Bush Set	PACK*120	<b>£11.85</b>
<b>B4993</b>	Ø0.25 x Ø1.45 x 1.15mm Bushes	PACK*10	<b>£1.65</b>
<b>B4994</b>	Ø0.40 x Ø1.45 x 1.20mm Bushes	PACK*10	<b>£1.65</b>
<b>B4995</b>	Ø0.50 x Ø1.45 x 1.20mm Bushes	PACK*10	<b>£1.65</b>
<b>B4996</b>	Ø0.60 x Ø1.45 x 1.30mm Bushes	PACK*10	<b>£1.65</b>
<b>B4997</b>	Ø0.70 x Ø1.45 x 1.30mm Bushes	PACK*10	<b>£1.65</b>
<b>B4998</b>	Ø0.80 x Ø2.00 x 1.50mm Bushes	PACK*10	<b>£1.65</b>
<b>B4999</b>	Ø0.90 x Ø2.00 x 1.50mm Bushes	PACK*10	<b>£1.65</b>
<b>B5000</b>	Ø1.00 x Ø2.00 x 1.60mm Bushes	PACK*10	<b>£1.65</b>
<b>B5001</b>	Ø1.25 x Ø2.00 x 1.60mm Bushes	PACK*10	<b>£1.65</b>
<b>B5002</b>	Ø1.50 x Ø2.90 x 2.00mm Bushes	PACK*10	<b>£1.65</b>
<b>B5003</b>	Ø1.75 x Ø2.90 x 2.00mm Bushes	PACK*10	<b>£1.80</b>
<b>B5004</b>	Ø2.00 x Ø3.00 x 2.90mm Bushes	PACK*10	<b>£1.80</b>

### Mantel Clock, General & Rimmed

Mantel Clock Bushes - Rimmed

Available in a graded box set or individually by size in packs of 10 pieces.



- For small mantel & alarm clocks
- Set (254) contains 10 sizes
- 10 of each size (100 pieces)
- Mixed rimmed and general
- Hole sizes included: Ø0.20, 0.25, 0.30, 0.40, 0.50, 0.75, 1.00, 1.25, 1.50, 1.80mm

Dimensions (approximate):

- Hole size x external diameter (not including rim) x height

Code	Description	UOM	Price
<b>B5007</b>	Rimmed Mantel Clock Bush Set	PACK*100	<b>£15.55</b>
<b>B4983</b>	Ø0.20 x 0.70 x 3.00mm Bushes	PACK*10	<b>£1.50</b>
<b>B4984</b>	Ø0.25 x 0.85 x 3.00mm Bushes	PACK*10	<b>£1.50</b>
<b>B4985</b>	Ø0.30 x 0.90 x 3.00mm Bushes	PACK*10	<b>£1.50</b>
<b>B4986</b>	Ø0.40 x 1.10 x 3.20mm Bushes	PACK*10	<b>£1.50</b>
<b>B4987</b>	Ø0.50 x 1.50 x 3.20mm Bushes	PACK*10	<b>£1.50</b>
<b>B4988</b>	Ø0.75 x 1.80 x 3.20mm Bushes	PACK*10	<b>£1.50</b>
<b>B4989</b>	Ø1.00 x 2.20 x 3.20mm Bushes	PACK*10	<b>£1.50</b>
<b>B4990</b>	Ø1.25 x 2.60 x 3.20mm Bushes	PACK*10	<b>£1.50</b>
<b>B4991</b>	Ø1.50 x 3.00 x 3.20mm Bushes	PACK*10	<b>£1.50</b>
<b>B4992</b>	Ø1.80 x 3.40 x 3.20mm Bushes	PACK*10	<b>£1.50</b>

**Clock Cutting & Smoothing Broaches**  
See Page 792

**GAUGED BUSHES BOXED SETS**



*Bergeon Swiss Made Brass Clock Bushes*

- Bergeon 4166 - Box Set (B1 to B30) - 225 Pieces
- Bergeon 5456 - Box Set (B31 to B60) - 225 Pieces
- Bergeon 5488 - Box Set (B1 to B60) - 450 Pieces
- Bergeon 6607 - Box Set (K Series) - 210 Pieces
- Bergeon 6717 - Box Set (B101 to B130) - 210 pieces

**Bergeon 4166 Set (B1 to B30)**



Clock Bushes - Bergeon 4166 - Box Set (B1 to B30)

- Bergeon Range B1 to B30
- Brass
- 225 pieces
- 30 sizes from pivot hole  $\varnothing 0.40\text{mm}$  to  $\varnothing 6.00\text{mm}$

Contains:

- 10 pieces each B1 to B15
- 5 pieces each B16 to B30

Code	Description	UOM	Price
B0263	Bergeon 4166 (B1 to B30)	PACK*225	£53.95



**Clock Bushing Tools**

Ref: B0291  
See Page: 813

**Bergeon 5456 Set (B31 to B60)**



Clock Bushes - Bergeon 5456 - Box Set (B31 to B60)

- Bergeon Range B31 to B60
- Brass
- 225 pieces
- 30 sizes from pivot hole  $\varnothing 0.30\text{mm}$  to  $\varnothing 6.50\text{mm}$

Contains:

- 10 pieces each B31 to B45
- 5 pieces each B46 to B60

Code	Description	UOM	Price
B0264	Bergeon 5456 (B31 to B60)	PACK*225	£45.95

**Bergeon 5488 Set (B1 to B60)**



Clock Bushes - Bergeon 5488 - Box Set (B1 to B60)

- Bergeon Range B1 to B60
- Brass
- 450 pieces
- 60 sizes from pivot hole  $\varnothing 0.30\text{mm}$  to  $\varnothing 6.50\text{mm}$

Contains:

- 10 pieces each B1 to B15
- 5 pieces each B16 to B30
- 10 pieces each B31 to B45
- 5 pieces each B46 to B60

Code	Description	UOM	Price
B4263	Bergeon 5488 (B1 to B60)	PACK*450	£89.95

**Bergeon 6607 Set (K Range)**



Clock Bushes - Bergeon 6607 - Box Set (K Series)

- Bergeon Range K Range Additional Sizes
- Brass
- 210 pieces

- 30 sizes from pivot hole  $\varnothing 0.40\text{mm}$  to  $\varnothing 6.00\text{mm}$

Contains: 7 pieces each K range sizes

Code	Description	UOM	Price
B0265	Bergeon 6607 (K Series)	PACK*210	£64.50

**Bergeon 6717 Set (B101 to B130)**



Clock Bushes - Bergeon 6717 - Box Set (B101 to B130)

- Bergeon Range B101 to B130 Range
- Additional Sizes for clock with thicker plates
- Brass
- 210 pieces
- 30 sizes from pivot hole  $\varnothing 0.80\text{mm}$  to  $\varnothing 6.00\text{mm}$

Contains: 7 pieces each B101 to B130 sizes

Code	Description	UOM	Price
B22311	Bergeon 6717 (B101 to B130)	PACK*210	£95.95

**GAUGED BUSHES INDIVIDUAL PACKETS**

*Bergeon Swiss Made Brass and Bronze Clock Bushes*

- Bergeon 30092, Brass (10 Packs) by Size
- Bergeon 30093, Brass (100 Packs) by Size
- Bergeon 4017, Bronze (10 Packs) by Size
- Bergeon 4017, Bronze (100 Packs) by Size

**Bergeon 30092, Brass (10 Packs)**

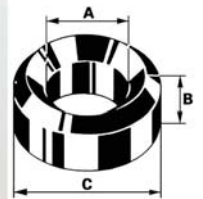

Clock Bushes - by Size - Brass

- Bergeon Swiss Made
- Brass
- Packs of 10 pieces per size
- Bergeon 30092 range

Dimensions in millimetres:

- A = Pivot Hole Diameter
- A\* = Undrilled
- B = Height
- C = Outside Diameter

In size order: A x B x C x (Bergeon reference 30092 +)

Code	Description	UOM	Price
B6831	A* x 5.0 x 3.0 (B127)	PACK*10	£4.15
B6832	A* x 5.0 x 4.0 (B128)	PACK*10	£4.15
B6833	A* x 5.0 x 5.0 (B129)	PACK*10	£4.15
B6834	A* x 5.0 x 6.0 (B130)	PACK*10	£4.15

B2177	0.30 x 1.5 x 2.0 (B31)	PACK*10	£3.25
B2147A	0.30 x 2.8 x 2.0 (B00)	PACK*10	£3.25
B2178	0.35 x 1.5 x 2.0 (B32)	PACK*10	£3.25
B2147C	0.40 x 1.5 x 2.0 (B1)	PACK*10	£2.45
B2179	0.40 x 2.0 x 2.0 (B33)	PACK*10	£3.25
B2147B	0.40 x 2.8 x 2.0 (B0)	PACK*10	£3.25
B2180	0.45 x 2.0 x 2.0 (B34)	PACK*10	£3.25
B2181	0.50 x 1.2 x 2.0 (B35)	PACK*10	£3.25
B2148	0.50 x 1.5 x 2.0 (B2)	PACK*10	£3.25
B2182	0.50 x 2.0 x 2.0 (B36)	PACK*10	£3.25
B2183	0.55 x 1.5 x 2.0 (B37)	PACK*10	£3.25
B2149	0.60 x 1.5 x 2.0 (B3)	PACK*10	£2.25
B6847	0.60 x 1.9 x 1.8 (K33)	PACK*10	£3.25
B2150	0.60 x 3.0 x 2.0 (B4)	PACK*10	£2.45
B2184	0.65 x 2.0 x 2.0 (B38)	PACK*10	£3.25
B6835	0.70 x 1.4 x 1.8 (K11)	PACK*10	£3.25
B2151	0.70 x 1.5 x 2.0 (B5)	PACK*10	£2.45
B6848	0.70 x 1.9 x 1.8 (K34)	PACK*10	£3.25
B2152	0.70 x 3.0 x 2.0 (B6)	PACK*10	£2.45
B2185	0.75 x 2.0 x 2.0 (B39)	PACK*10	£3.25
B6836	0.80 x 1.4 x 1.8 (K12)	PACK*10	£3.25
B2153	0.80 x 1.5 x 2.5 (B7)	PACK*10	£2.45
B6849	0.80 x 1.9 x 1.8 (K35)	PACK*10	£3.25
B2154	0.80 x 3.0 x 2.5 (B8)	PACK*10	£2.45
B6805	0.80 x 5.0 x 2.0 (B101)	PACK*10	£4.15
B2186	0.85 x 2.0 x 2.5 (B40)	PACK*10	£3.25
B6837	0.90 x 1.4 x 1.8 (K13)	PACK*10	£3.25
B2155	0.90 x 1.5 x 2.5 (B9)	PACK*10	£2.45
B6850	0.90 x 1.9 x 1.8 (K36)	PACK*10	£3.25
B2156	0.90 x 3.0 x 2.5 (B10)	PACK*10	£2.45
B2187	0.95 x 1.2 x 2.5 (B41)	PACK*10	£3.25
B6838	1.00 x 1.4 x 2.7 (K14)	PACK*10	£3.25
B2157	1.00 x 1.5 x 3.0 (B11)	PACK*10	£2.45
B6851	1.00 x 1.9 x 1.8 (K37)	PACK*10	£3.25
B2188	1.00 x 2.0 x 3.0 (B42)	PACK*10	£3.25
B2158	1.00 x 3.0 x 3.0 (B12)	PACK*10	£2.45
B6806	1.00 x 5.0 x 2.0 (B102)	PACK*10	£4.15
B6807	1.00 x 5.0 x 2.5 (B103)	PACK*10	£4.15
B6860	1.10 x 1.4 x 1.8 (K66)	PACK*10	£3.25
B6839	1.10 x 1.4 x 2.7 (K15)	PACK*10	£3.25
B6852	1.10 x 1.9 x 2.7 (K38)	PACK*10	£3.25
B2189	1.10 x 2.0 x 3.0 (B43)	PACK*10	£3.25
B6840	1.20 x 1.4 x 2.7 (K16)	PACK*10	£3.25
B6853	1.20 x 1.9 x 2.7 (K39)	PACK*10	£3.25
B2190	1.20 x 2.0 x 3.0 (B44)	PACK*10	£3.25
B6808	1.20 x 5.0 x 2.5 (B104)	PACK*10	£4.15
B6809	1.20 x 5.0 x 3.0 (B105)	PACK*10	£4.15
B2159	1.25 x 1.5 x 3.0 (B13)	PACK*10	£2.45
B2191	1.25 x 2.0 x 3.0 (B45)	PACK*10	£3.25
B2160	1.25 x 3.0 x 3.0 (B14)	PACK*10	£2.45
B6841	1.30 x 1.4 x 2.7 (K17)	PACK*10	£3.25
B6854	1.30 x 1.9 x 2.7 (K40)	PACK*10	£3.25
B2192	1.30 x 2.0 x 3.0 (B46)	PACK*10	£3.25
B6842	1.40 x 1.4 x 2.7 (K18)	PACK*10	£3.25
B6855	1.40 x 1.9 x 2.7 (K41)	PACK*10	£3.25
B2193	1.40 x 2.0 x 3.5 (B47)	PACK*10	£3.25
B6810	1.40 x 5.0 x 2.5 (B106)	PACK*10	£4.15
B6811	1.40 x 5.0 x 3.0 (B107)	PACK*10	£4.15
B6843	1.50 x 1.4 x 2.7 (K19)	PACK*10	£3.25
B2161	1.50 x 1.5 x 3.5 (B15)	PACK*10	£2.45
B6856	1.50 x 1.9 x 2.7 (K42)	PACK*10	£3.25
B2194	1.50 x 2.0 x 3.5 (B48)	PACK*10	£3.25
B2162	1.50 x 3.0 x 3.5 (B16)	PACK*10	£2.45
B6844	1.60 x 1.4 x 2.7 (K20)	PACK*10	£3.25
B2195	1.60 x 1.5 x 3.5 (B49)	PACK*10	£3.25
B6857	1.60 x 1.9 x 2.7 (K43)	PACK*10	£3.25
B6812	1.60 x 5.0 x 3.0 (B108)	PACK*10	£3.95
B6813	1.60 x 5.0 x 3.5 (B109)	PACK*10	£3.95
B2196	1.65 x 2.0 x 3.5 (B50)	PACK*10	£3.25
B6861	1.70 x 1.4 x 2.7 (K67)	PACK*10	£3.25
B6863	1.70 x 1.9 x 2.7 (K88)	PACK*10	£3.25
B2197	1.70 x 2.0 x 3.5 (B51)	PACK*10	£3.25
B2163	1.75 x 1.5 x 3.5 (B17)	PACK*10	£2.45
B2164	1.75 x 3.0 x 3.5 (B18)	PACK*10	£2.45
B6845	1.80 x 1.4 x 2.7 (K21)	PACK*10	£3.25

B6858	1.80 x 1.9 x 2.7 (K44)	PACK*10	£3.25
B2198	1.80 x 2.0 x 3.5 (B52)	PACK*10	£3.25
B6814	1.80 x 5.0 x 3.0 (B110)	PACK*10	£3.95
B6815	1.80 x 5.0 x 3.5 (B111)	PACK*10	£3.95
B6862	1.90 x 1.4 x 2.7 (K68)	PACK*10	£3.25
B6864	1.90 x 1.9 x 2.7 (K89)	PACK*10	£3.25
B2199	1.90 x 2.0 x 3.5 (B53)	PACK*10	£3.25
B6846	2.00 x 1.4 x 3.5 (K22)	PACK*10	£3.25
B2165	2.00 x 1.5 x 4.5 (B19)	PACK*10	£2.45
B6859	2.00 x 1.9 x 3.5 (K45)	PACK*10	£3.25
B2200	2.00 x 2.0 x 4.5 (B54)	PACK*10	£3.25
B2166	2.00 x 3.0 x 4.5 (B20)	PACK*10	£2.45
B6816	2.00 x 5.0 x 3.5 (B112)	PACK*10	£4.15
B6817	2.00 x 5.0 x 4.0 (B113)	PACK*10	£4.15
B2201	2.10 x 2.0 x 4.5 (B55)	PACK*10	£3.25
B6818	2.20 x 5.0 x 3.5 (B114)	PACK*10	£4.15
B6819	2.20 x 5.0 x 4.0 (B115)	PACK*10	£4.15
B2167	2.25 x 1.5 x 4.5 (B21)	PACK*10	£2.45
B2202	2.25 x 2.0 x 4.5 (B56)	PACK*10	£3.25
B2168	2.25 x 3.0 x 4.5 (B22)	PACK*10	£2.45
B2203	2.40 x 2.0 x 4.5 (B57)	PACK*10	£3.25
B6820	2.40 x 5.0 x 3.5 (B116)	PACK*10	£4.15
B6821	2.40 x 5.0 x 4.0 (B117)	PACK*10	£4.15
B2169	2.50 x 1.5 x 4.5 (B23)	PACK*10	£2.45
B2170	2.50 x 3.0 x 4.5 (B24)	PACK*10	£2.45
B6822	2.60 x 5.0 x 3.5 (B118)	PACK*10	£4.15
B6823	2.60 x 5.0 x 4.0 (B119)	PACK*10	£4.15
B2204	2.75 x 2.0 x 4.5 (B58)	PACK*10	£3.25
B6824	2.80 x 5.0 x 4.0 (B120)	PACK*10	£4.15
B2171	3.00 x 1.5 x 5.5 (B25)	PACK*10	£3.25
B2172	3.00 x 3.0 x 5.5 (B26)	PACK*10	£3.25
B6825	3.00 x 5.0 x 4.5 (B121)	PACK*10	£4.15
B2173	4.00 x 1.5 x 6.5 (B27)	PACK*10	£4.25
B2174	4.00 x 3.0 x 6.5 (B28)	PACK*10	£4.25
B6826	4.00 x 5.0 x 6.0 (B122)	PACK*10	£4.25
B6827	4.50 x 5.0 x 6.5 (B123)	PACK*10	£4.25
B2205	5.00 x 2.0 x 8.5 (B59)	PACK*10	£5.95
B2175	5.00 x 3.0 x 7.5 (B29)	PACK*10	£4.25
B6828	5.00 x 5.0 x 7.0 (B124)	PACK*10	£4.25
B2176	6.00 x 3.0 x 8.5 (B30)	PACK*10	£4.25
B6829	6.00 x 5.0 x 8.0 (B125)	PACK*10	£4.25
B2206	6.50 x 2.0 x 8.5 (B60)	PACK*10	£5.95
B6830	6.50 x 5.0 x 8.5 (B126)	PACK*10	£4.25

B2239	0.35 x 1.5 x 2.0 (B32)	PACK*100	£21.95
B2208	0.40 x 1.5 x 2.0 (B1)	PACK*100	£21.95
B2240	0.40 x 2.0 x 2.0 (B33)	PACK*100	£21.95
B2207A	0.40 x 2.8 x 2.0 (B0)	PACK*100	£21.95
B2241	0.45 x 2.0 x 2.0 (B34)	PACK*100	£21.95
B2242	0.50 x 1.2 x 2.0 (B35)	PACK*100	£21.95
B2209	0.50 x 1.5 x 2.0 (B2)	PACK*100	£21.95
B2243	0.50 x 2.0 x 2.0 (B36)	PACK*100	£21.95
B2244	0.55 x 1.5 x 2.0 (B37)	PACK*100	£21.95
B2210	0.60 x 1.5 x 2.0 (B3)	PACK*100	£21.95
B6907	0.60 x 1.9 x 1.8 (K33)	PACK*100	£21.95
B2211	0.60 x 3.0 x 2.0 (B4)	PACK*100	£21.95
B2245	0.65 x 2.0 x 2.0 (B38)	PACK*100	£21.95
B6895	0.70 x 1.4 x 1.8 (K11)	PACK*100	£21.95
B2212	0.70 x 1.5 x 2.0 (B5)	PACK*100	£21.95
B6908	0.70 x 1.9 x 1.8 (K34)	PACK*100	£21.95
B2213	0.70 x 3.0 x 2.0 (B6)	PACK*100	£21.95
B2246	0.75 x 2.0 x 2.0 (B39)	PACK*100	£21.95
B6896	0.80 x 1.4 x 1.8 (K12)	PACK*100	£21.95
B2214	0.80 x 1.5 x 2.5 (B7)	PACK*100	£21.95
B2215	0.80 x 3.0 x 2.5 (B8)	PACK*100	£21.95
B2247	0.85 x 2.0 x 2.5 (B40)	PACK*100	£21.95
B6897	0.90 x 1.4 x 1.8 (K13)	PACK*100	£21.95
B2216	0.90 x 1.5 x 2.5 (B9)	PACK*100	£21.95
B6910	0.90 x 1.9 x 1.8 (K36)	PACK*100	£21.95
B2217	0.90 x 3.0 x 2.5 (B10)	PACK*100	£21.95
B2248	0.95 x 1.2 x 2.5 (B41)	PACK*100	£21.95
B6898	1.00 x 1.4 x 2.7 (K14)	PACK*100	£21.95
B2218	1.00 x 1.5 x 3.0 (B11)	PACK*100	£21.95
B6911	1.00 x 1.9 x 1.8 (K37)	PACK*100	£21.95
B2249	1.00 x 2.0 x 3.0 (B42)	PACK*100	£21.95
B2219	1.00 x 3.0 x 3.0 (B12)	PACK*100	£21.95
B6866	1.00 x 5.0 x 2.0 (B102)	PACK*100	£28.95
B6867	1.00 x 5.0 x 2.5 (B103)	PACK*100	£28.95
B6920	1.10 x 1.4 x 1.8 (K66)	PACK*100	£21.95
B6899	1.10 x 1.4 x 2.7 (K15)	PACK*100	£21.95
B6912	1.10 x 1.9 x 2.7 (K38)	PACK*100	£21.95
B2250	1.10 x 2.0 x 3.0 (B43)	PACK*100	£21.95
B6900	1.20 x 1.4 x 2.7 (K16)	PACK*100	£21.95
B6913	1.20 x 1.9 x 2.7 (K39)	PACK*100	£21.95
B2251	1.20 x 2.0 x 3.0 (B44)	PACK*100	£21.95
B6868	1.20 x 5.0 x 2.5 (B104)	PACK*100	£28.95
B6869	1.20 x 5.0 x 3.0 (B105)	PACK*100	£28.95
B2220	1.25 x 1.5 x 3.0 (B13)	PACK*100	£21.95
B2252	1.25 x 2.0 x 3.0 (B45)	PACK*100	£21.95
B2221	1.25 x 3.0 x 3.0 (B14)	PACK*100	£21.95
B6901	1.30 x 1.4 x 2.7 (K17)	PACK*100	£21.95
B2253	1.30 x 2.0 x 3.0 (B46)	PACK*100	£21.95
B6902	1.40 x 1.4 x 2.7 (K18)	PACK*100	£21.95
B6915	1.40 x 1.9 x 2.7 (K41)	PACK*100	£21.95
B2254	1.40 x 2.0 x 3.5 (B47)	PACK*100	£21.95
B6870	1.40 x 5.0 x 2.5 (B106)	PACK*100	£28.95
B6871	1.40 x 5.0 x 3.0 (B107)	PACK*100	£28.95
B6903	1.50 x 1.4 x 2.7 (K19)	PACK*100	£21.95
B2222	1.50 x 1.5 x 3.5 (B15)	PACK*100	£21.95
B6916	1.50 x 1.9 x 2.7 (K42)	PACK*100	£21.95
B2255	1.50 x 2.0 x 3.5 (B48)	PACK*100	£21.95
B2223	1.50 x 3.0 x 3.5 (B16)	PACK*100	£21.95
B6904	1.60 x 1.4 x 2.7 (K20)	PACK*100	£21.95
B2256	1.60 x 1.5 x 3.5 (B49)	PACK*100	£21.95
B6917	1.60 x 1.9 x 2.7 (K43)	PACK*100	£21.95
B6872	1.60 x 5.0 x 3.0 (B108)	PACK*100	£28.95
B6873	1.60 x 5.0 x 3.5 (B109)	PACK*100	£28.95
B2257	1.65 x 2.0 x 3.5 (B50)	PACK*100	£21.95
B6921	1.70 x 1.4 x 2.7 (K67)	PACK*100	£21.95
B6923	1.70 x 1.9 x 2.7 (K88)	PACK*100	£21.95
B2258	1.70 x 2.0 x 3.5 (B51)	PACK*100	£21.95
B2224	1.75 x 1.5 x 3.5 (B17)	PACK*100	£21.95
B2225	1.75 x 3.0 x 3.5 (B18)	PACK*100	£21.95
B6905	1.80 x 1.4 x 2.7 (K21)	PACK*100	£21.95
B6918	1.80 x 1.9 x 2.7 (K44)	PACK*100	£21.95
B2259	1.80 x 2.0 x 3.5 (B52)	PACK*100	£21.95
B6874	1.80 x 5.0 x 3.0 (B110)	PACK*100	£28.95
B6875	1.80 x 5.0 x 3.5 (B111)	PACK*100	£28.95
B6922	1.90 x 1.4 x 2.7 (K68)	PACK*100	£21.95

Bergeon 30093, Brass (100 Pack)

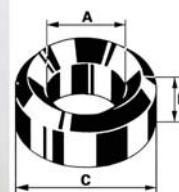

Clock Bushes - by Size - Brass

- Bergeon Swiss Made
- Brass
- Packs of 100 pieces per size
- Bergeon 30093 range

Dimensions in millimetres:

- A = Pivot Hole Diameter
- A\* = Undrilled
- B = Height
- C = Outside Diameter

In size order: A x B x C x (Bergeon reference 30093 +)

Code	Description	UOM	Price
B6891	A* x 5.0 x 3.0 (B127)	PACK*100	£28.95
B6892	A* x 5.0 x 4.0 (B128)	PACK*100	£28.95
B6893	A* x 5.0 x 5.0 (B129)	PACK*100	£28.95
B6894	A* x 5.0 x 6.0 (B130)	PACK*100	£28.95
B2238	0.30 x 1.5 x 2.0 (B31)	PACK*100	£21.95
B2207	0.30 x 2.8 x 2.0 (B00)	PACK*100	£21.95

# BUSHES (CLOCK)

B6924	1.90 x 1.9 x 2.7 (K89)	PACK*100	£21.95
B2260	1.90 x 2.0 x 3.5 (B53)	PACK*100	£21.95
B6906	2.00 x 1.4 x 3.5 (K22)	PACK*100	£21.95
B2226	2.00 x 1.5 x 4.5 (B19)	PACK*100	£21.95
B6919	2.00 x 1.9 x 3.5 (K45)	PACK*100	£21.95
B2261	2.00 x 2.0 x 4.5 (B54)	PACK*100	£21.95
B2227	2.00 x 3.0 x 4.5 (B20)	PACK*100	£21.95
B6876	2.00 x 5.0 x 3.5 (B112)	PACK*100	£28.95
B6877	2.00 x 5.0 x 4.0 (B113)	PACK*100	£28.95
B2262	2.10 x 2.0 x 4.5 (B55)	PACK*100	£21.95
B6878	2.20 x 5.0 x 3.5 (B114)	PACK*100	£28.95
B6879	2.20 x 5.0 x 4.0 (B115)	PACK*100	£29.95
B2228	2.25 x 1.5 x 4.5 (B21)	PACK*100	£21.95
B2263	2.25 x 2.0 x 4.5 (B56)	PACK*100	£21.95
B2229	2.25 x 3.0 x 4.5 (B22)	PACK*100	£21.95
B2264	2.40 x 2.0 x 4.5 (B57)	PACK*100	£21.95
B6880	2.40 x 5.0 x 3.5 (B116)	PACK*100	£28.95
B6881	2.40 x 5.0 x 4.0 (B117)	PACK*100	£28.95
B2230	2.50 x 1.5 x 4.5 (B23)	PACK*100	£21.95
B2231	2.50 x 3.0 x 4.5 (B24)	PACK*100	£28.95
B6882	2.60 x 5.0 x 3.5 (B118)	PACK*100	£28.95
B6883	2.60 x 5.0 x 4.0 (B119)	PACK*100	£28.95
B2265	2.75 x 2.0 x 4.5 (B58)	PACK*100	£21.95
B6884	2.80 x 5.0 x 4.0 (B120)	PACK*100	£28.95
B2232	3.00 x 1.5 x 5.5 (B25)	PACK*100	£21.95
B2233	3.00 x 3.0 x 5.5 (B26)	PACK*100	£28.95
B6885	3.00 x 5.0 x 4.5 (B121)	PACK*100	£28.95
B2234	4.00 x 1.5 x 6.5 (B27)	PACK*100	£21.95
B2235	4.00 x 3.0 x 6.5 (B28)	PACK*100	£28.95
B6886	4.00 x 5.0 x 6.0 (B122)	PACK*100	£28.95
B6887	4.50 x 5.0 x 6.5 (B123)	PACK*100	£28.95
B2266	5.00 x 2.0 x 8.5 (B59)	PACK*100	£49.95
B2236	5.00 x 3.0 x 7.5 (B29)	PACK*100	£28.95
B6888	5.00 x 5.0 x 7.0 (B124)	PACK*100	£28.95
B2237	6.00 x 3.0 x 8.5 (B30)	PACK*100	£28.95
B6889	6.00 x 5.0 x 8.0 (B125)	PACK*100	£28.95
B2267	6.50 x 2.0 x 8.5 (B60)	PACK*100	£21.95
B6890	6.50 x 5.0 x 8.5 (B126)	PACK*100	£28.95

## Bergeon 4019, Bronze (10 Packs)

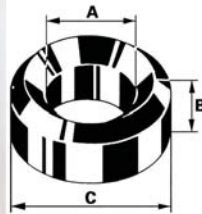

Clock Bushes - by Size - Bronze

- Bergeon Swiss Made
- Bronze (Harder wearing than Brass)
- Packs of 10 pieces per size
- Bergeon 4019 range

Dimensions in millimetres:

- A = Pivot Hole Diameter
- B = Height
- C = Outside Diameter

In size order: A x B x C x (Bergeon reference 4019-P-10 +)

Code	Description	UOM	Price
B6956	0.30 x 1.5 x 2.0 (B31)	PACK*10	£3.50
B13762	0.30 x 2.8 x 2.0 (B00)	PACK*10	£3.50
B6957	0.35 x 1.5 x 2.0 (B32)	PACK*10	£3.50
B6926	0.40 x 1.5 x 2.0 (B1)	PACK*10	£3.50
B6958	0.40 x 2.0 x 2.0 (B33)	PACK*10	£3.50
B6925	0.40 x 2.8 x 2.0 (B0)	PACK*10	£3.50
B6959	0.45 x 2.0 x 2.0 (B34)	PACK*10	£3.50
B6960	0.50 x 1.2 x 2.0 (B35)	PACK*10	£3.50
B6927	0.50 x 1.5 x 2.0 (B2)	PACK*10	£3.50
B6961	0.50 x 2.0 x 2.0 (B36)	PACK*10	£3.50

B6962	0.55 x 1.5 x 2.0 (B37)	PACK*10	£3.50
B6928	0.60 x 1.5 x 2.0 (B3)	PACK*10	£3.50
B6929	0.60 x 3.0 x 2.0 (B4)	PACK*10	£3.50
B6963	0.65 x 2.0 x 2.0 (B38)	PACK*10	£3.50
B6930	0.70 x 1.5 x 2.0 (B5)	PACK*10	£3.50
B6931	0.70 x 3.0 x 2.0 (B6)	PACK*10	£3.00
B6964	0.75 x 2.0 x 2.0 (B39)	PACK*10	£3.00
B6932	0.80 x 1.5 x 2.5 (B7)	PACK*10	£3.00
B6933	0.80 x 3.0 x 2.5 (B8)	PACK*10	£3.00
B6965	0.85 x 2.0 x 2.5 (B40)	PACK*10	£3.00
B6934	0.90 x 1.5 x 2.5 (B9)	PACK*10	£3.00
B6935	0.90 x 3.0 x 2.5 (B10)	PACK*10	£3.00
B6966	0.95 x 1.2 x 2.5 (B41)	PACK*10	£3.00
B6936	1.00 x 1.5 x 3.0 (B11)	PACK*10	£3.00
B6967	1.00 x 2.0 x 3.0 (B42)	PACK*10	£3.00
B6937	1.00 x 3.0 x 3.0 (B12)	PACK*10	£3.00
B6968	1.10 x 2.0 x 3.0 (B43)	PACK*10	£3.00
B6969	1.20 x 2.0 x 3.0 (B44)	PACK*10	£3.00
B6938	1.25 x 1.5 x 3.0 (B13)	PACK*10	£3.00
B6970	1.25 x 2.0 x 3.0 (B45)	PACK*10	£3.00
B6939	1.25 x 3.0 x 3.0 (B14)	PACK*10	£3.00
B6971	1.30 x 2.0 x 3.0 (B46)	PACK*10	£3.00
B6972	1.40 x 2.0 x 3.5 (B47)	PACK*10	£3.00
B6940	1.50 x 1.5 x 3.5 (B15)	PACK*10	£3.00
B6973	1.50 x 2.0 x 3.5 (B48)	PACK*10	£3.00
B6941	1.50 x 3.0 x 3.5 (B16)	PACK*10	£3.00
B6974	1.60 x 1.5 x 3.5 (B49)	PACK*10	£3.00
B6975	1.65 x 2.0 x 3.5 (B50)	PACK*10	£3.00
B6976	1.70 x 2.0 x 3.5 (B51)	PACK*10	£3.00
B6942	1.75 x 1.5 x 3.5 (B17)	PACK*10	£3.00
B6943	1.75 x 3.0 x 3.5 (B18)	PACK*10	£3.00
B6977	1.80 x 2.0 x 3.5 (B52)	PACK*10	£3.00
B6978	1.90 x 2.0 x 3.5 (B53)	PACK*10	£3.00
B6944	2.00 x 1.5 x 4.5 (B19)	PACK*10	£3.00
B6979	2.00 x 2.0 x 4.5 (B54)	PACK*10	£3.00
B6945	2.00 x 3.0 x 4.5 (B20)	PACK*10	£3.00
B6980	2.10 x 2.0 x 4.5 (B55)	PACK*10	£3.00
B6946	2.25 x 1.5 x 4.5 (B21)	PACK*10	£3.00
B6981	2.25 x 2.0 x 4.5 (B56)	PACK*10	£3.00
B6947	2.25 x 3.0 x 4.5 (B22)	PACK*10	£3.50
B6982	2.40 x 2.0 x 4.5 (B57)	PACK*10	£3.50
B6948	2.50 x 1.5 x 4.5 (B23)	PACK*10	£3.50
B6949	2.50 x 3.0 x 4.5 (B24)	PACK*10	£3.50
B6983	2.75 x 2.0 x 4.5 (B58)	PACK*10	£3.50
B6950	3.00 x 1.5 x 5.5 (B25)	PACK*10	£3.50
B6951	3.00 x 3.0 x 5.5 (B26)	PACK*10	£3.50
B6952	4.00 x 1.5 x 6.5 (B27)	PACK*10	£7.95
B6953	4.00 x 3.0 x 6.5 (B28)	PACK*10	£7.95
B6984	5.00 x 2.0 x 8.5 (B59)	PACK*10	£7.95
B6954	5.00 x 3.0 x 7.5 (B29)	PACK*10	£7.95
B6955	6.00 x 3.0 x 8.5 (B30)	PACK*10	£7.95
B6985	6.50 x 2.0 x 8.5 (B60)	PACK*10	£7.95

## Bergeon 4019, Bronze (100 Packs)

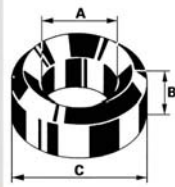

Clock Bushes - by Size - Bronze

- Bergeon Swiss Made
- Bronze (Harder wearing than Brass)
- Packs of 100 pieces per size
- Bergeon 4019 range

Dimensions in millimetres:

- A = Pivot Hole Diameter
- B = Height
- C = Outside Diameter

In size order: A x B x C x (Bergeon reference 4019-P-100 +)

Code	Description	UOM	Price
B7017	0.30 x 1.5 x 2.0 (B31)	PACK*100	£20.95
B13761	0.30 x 2.8 x 2.0 (B00)	PACK*100	£20.95
B7018	0.35 x 1.5 x 2.0 (B32)	PACK*100	£20.95
B6987	0.40 x 1.5 x 2.0 (B1)	PACK*100	£20.95
B7019	0.40 x 2.0 x 2.0 (B33)	PACK*100	£20.95
B6986	0.40 x 2.8 x 2.0 (B0)	PACK*100	£20.95
B7020	0.45 x 2.0 x 2.0 (B34)	PACK*100	£20.95
B7021	0.50 x 1.2 x 2.0 (B35)	PACK*100	£20.95
B6988	0.50 x 1.5 x 2.0 (B2)	PACK*100	£20.95
B7022	0.50 x 2.0 x 2.0 (B36)	PACK*100	£20.95
B7023	0.55 x 1.5 x 2.0 (B37)	PACK*100	£20.95
B6989	0.60 x 1.5 x 2.0 (B3)	PACK*100	£20.95
B6990	0.60 x 3.0 x 2.0 (B4)	PACK*100	£20.95
B8601	0.65 x 2.0 x 2.0 (B38)	PACK*100	£20.95
B6991	0.70 x 1.5 x 2.0 (B5)	PACK*100	£20.95
B6992	0.70 x 3.0 x 2.0 (B6)	PACK*100	£20.95
B8602	0.75 x 2.0 x 2.0 (B39)	PACK*100	£20.95
B6993	0.80 x 1.5 x 2.5 (B7)	PACK*100	£20.95
B6994	0.80 x 3.0 x 2.5 (B8)	PACK*100	£20.95
B7026	0.85 x 2.0 x 2.5 (B40)	PACK*100	£20.95
B6995	0.90 x 1.5 x 2.5 (B9)	PACK*100	£20.95
B6996	0.90 x 3.0 x 2.5 (B10)	PACK*100	£20.95
B7027	0.95 x 1.2 x 2.5 (B41)	PACK*100	£20.95
B6997	1.00 x 1.5 x 3.0 (B11)	PACK*100	£20.95
B7028	1.00 x 2.0 x 3.0 (B42)	PACK*100	£20.95
B6998	1.00 x 3.0 x 3.0 (B12)	PACK*100	£20.95
B7029	1.10 x 2.0 x 3.0 (B43)	PACK*100	£20.95
B7030	1.20 x 2.0 x 3.0 (B44)	PACK*100	£20.95
B6999	1.25 x 1.5 x 3.0 (B13)	PACK*100	£20.95
B7031	1.25 x 2.0 x 3.0 (B45)	PACK*100	£20.95
B7000	1.25 x 3.0 x 3.0 (B14)	PACK*100	£20.95
B7032	1.30 x 2.0 x 3.0 (B46)	PACK*100	£20.95
B7033	1.40 x 2.0 x 3.5 (B47)	PACK*100	£20.95
B7001	1.50 x 1.5 x 3.5 (B15)	PACK*100	£20.95
B7034	1.50 x 2.0 x 3.5 (B48)	PACK*100	£20.95
B7002	1.50 x 3.0 x 3.5 (B16)	PACK*100	£20.95
B7035	1.60 x 1.5 x 3.5 (B49)	PACK*100	£20.95
B7036	1.65 x 2.0 x 3.5 (B50)	PACK*100	£20.95
B7037	1.70 x 2.0 x 3.5 (B51)	PACK*100	£20.95
B7003	1.75 x 1.5 x 3.5 (B17)	PACK*100	£20.95
B7004	1.75 x 3.0 x 3.5 (B18)	PACK*100	£20.95
B7038	1.80 x 2.0 x 3.5 (B52)	PACK*100	£20.95
B7039	1.90 x 2.0 x 3.5 (B53)	PACK*100	£20.95
B7005	2.00 x 1.5 x 4.5 (B19)	PACK*100	£20.95
B7040	2.00 x 2.0 x 4.5 (B54)	PACK*100	£20.95
B7006	2.00 x 3.0 x 4.5 (B20)	PACK*100	£20.95
B7041	2.10 x 2.0 x 4.5 (B55)	PACK*100	£20.95
B7007	2.25 x 1.5 x 4.5 (B21)	PACK*100	£20.95
B7042	2.25 x 2.0 x 4.5 (B56)	PACK*100	£20.95
B7008	2.25 x 3.0 x 4.5 (B22)	PACK*100	£20.95
B7043	2.40 x 2.0 x 4.5 (B57)	PACK*100	£20.95
B7009	2.50 x 1.5 x 4.5 (B23)	PACK*100	£20.95
B7010	2.50 x 3.0 x 4.5 (B24)	PACK*100	£20.95
B7044	2.75 x 2.0 x 4.5 (B58)	PACK*100	£20.95
B7011	3.00 x 1.5 x 5.5 (B25)	PACK*100	£20.95
B7012	3.00 x 3.0 x 5.5 (B26)	PACK*100	£20.95
B7013	4.00 x 1.5 x 6.5 (B27)	PACK*100	£24.95
B7014	4.00 x 3.0 x 6.5 (B28)	PACK*100	£24.95
B7045	5.00 x 2.0 x 8.5 (B59)	PACK*100	£45.50
B7015	5.00 x 3.0 x 7.5 (B29)	PACK*100	£45.50
B7016	6.00 x 3.0 x 8.5 (B30)	PACK*100	£45.50
B7046	6.50 x 2.0 x 8.5 (B60)	PACK*100	£45.50

 Online Discounts

**PRICE PROMISE**  
**GUARANTEE** 



## LONGCASE CLOCK BUSHES

### Longcase Clock Barrel Bushes



#### Longcase Clock Barrel Bushes

These can be used on worn barrels or the large bearing holes in front plates of Longcase or modern mass produced clocks.

- Brass
- UK Made
- Non EU made\*
- Hole Ø3mm to Ø12mm
- Packs of 5 or 10 pieces

Dimensions in millimetres:

- A = Hole Ø
- B = Overall Height
- C = Bush Outer Ø
- D = Overall Outer Ø

Code	Description	UOM	Price
L2511	A:3.00 x B:6.00 x C:6.00 x D:9.50mm	PACK*5	£2.90
L2512	A:4.00 x B:6.00 x C:7.00 x D:9.50mm	PACK*5	£2.90
L31373	A:4.30 x B:6.15 x C:10.00 x D:11.50mm*	PACK*10	£2.75
L2513	A:4.90 x B:5.75 x C:8.00 x D:9.50mm	PACK*5	£2.90
L2514	A:6.00 x B:6.00 x C:9.00 x D:11.00mm	PACK*5	£3.20
L2515	A:6.90 x B:5.75 x C:10.00 x D:12.70mm	PACK*5	£3.20
L31372	A:7.85 x B:5.40 x C:9.60 x D:13.05mm*	PACK*10	£2.75
L31371	A:8.00 x B:5.50 x C:10.90 x D:13.85mm*	PACK*10	£2.75
L2516	A:8.90 x B:5.75 x C:11.00 x D:12.70mm	PACK*5	£3.20
L2517	A:10.00 x B:5.75 x C:12.00 x D:14.25mm	PACK*5	£3.20
L2518	A:11.00 x B:6.00 x C:13.00 x D:15.80mm	PACK*5	£3.20
L2519	A:12.00 x B:6.25 x C:14.00 x D:15.90mm	PACK*5	£3.20

### Longcase Clock Winding Arbour Bushes

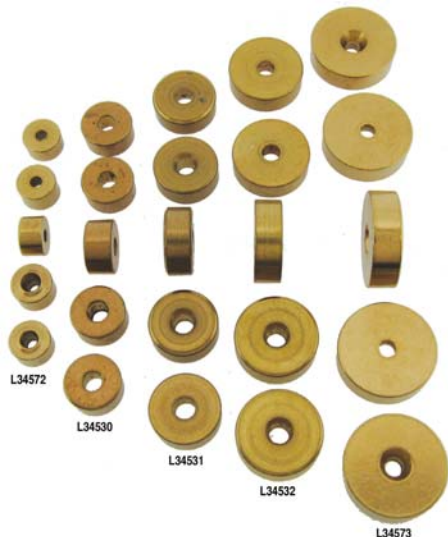

Winding arbour bushes are designed to be used for repairing badly worn plates on antique Longcase & Bracket clocks, particularly around the large holes at

the bottom of the plates where the winding arbours are located.

The bushes are manufactured from yellow riveting Brass which gives a very close match to the original cast plates. Machined with a slight taper on the outside diameter, the bushes can be driven into a precisely drilled hole, riveted over, then filed and polished out to give a near invisible repair.

The 3mm hole is only a pilot to enable the repairer to drill and broach to the exact size required, this is also useful if the plates have been centre punched in the past, as the repairer can use a larger bush, to remove the punched up part of the plate.

- Large flush fitting tapered bushes, manufactured for English Longcase & Bracket Clocks
- Bushes on average will come up slightly oversize
- The holes are only a pilot to enable the repairer to drill and broach to the exact size required.
- Dimensions are Outside diameter x Thickness (Minimum)
- Made in UK

Code	Description	UOM	Price
L34572	Ø6mm x 4mm Thick	PACK*5	£2.90
L34530	Ø8mm x 4mm Thick	PACK*5	£2.90
L34531	Ø10mm x 4mm Thick	PACK*5	£3.20
L34532	Ø12mm x 4mm Thick	PACK*5	£3.65
L34573	Ø14mm x 4mm Thick	PACK*5	£3.75

## SCREW IN BUSHES

### Screw in Clock Bushes



#### Screw in Clock Bushes

- A\*F Swiss
- Brass screw in bushes
- Set of 75
- For Clock Bushing Tool: B19465
- Diameter 5mm
- Thickness 1.8mm or 3mm
- Hole Ø: 0.70, 0.80, 0.90, 1.00, 1.25, 1.50, 1.75, 2.00mm

Sizes: Thickness x Hole Diameter

Code	Description	UOM	Price
B19469	Screw In Bush Set of 75	PACK*75	£169.95
B19469A	1.8mm x Ø0.70mm	EACH	£1.40
B19469B	1.8mm x Ø0.80mm	EACH	£1.40
B19469C	1.8mm x Ø0.90mm	EACH	£1.40
B19469D	1.8mm x Ø1.00mm	EACH	£1.40
B19469E	1.8mm x Ø1.25mm	EACH	£1.40
B19469F	1.8mm x Ø1.50mm	EACH	£1.40
B19469G	1.8mm x Ø1.75mm	EACH	£1.40
B19469H	1.8mm x Ø2.00mm	EACH	£1.40
B19469I	3mm x Ø0.70mm	EACH	£1.40
B19469K	3mm x Ø0.90mm	EACH	£1.40
B19469L	3mm x Ø1.00mm	EACH	£1.40
B19469M	3mm x Ø1.25mm	EACH	£1.40

B19469N	3mm x Ø1.50mm	EACH	£1.40
B19469P	3mm x Ø1.75mm	EACH	£1.40
B19469Q	3mm x Ø2.00mm	EACH	£1.40
Price breaks available, see website			

## SPECIAL PROFILE BUSHES

### Brass, Blind & Pierced



Special Profile (Universal) Clock Bushes - Size to your requirements - Brass

- Unfinished
- Shape to your needs
- Blind - Non-drilled
- Pierced - Drilled

### Blind (Diagram 226)



- Swiss Made

Code	Description	UOM	Price
S37405	Blind (Diagram 226)	PACK*100	£10.50

### Blind, (Diagram 231) - Box Set



- Swiss Made

Set Includes:

- Ø1.30mm
- Ø1.50mm
- Ø1.60mm
- Ø1.80mm
- Ø2.00mm
- Ø2.20mm
- Ø2.40mm
- Ø2.60mm
- Ø2.80mm
- Ø3.00mm

Code	Description	UOM	Price
S37410	Blind, (Diagram 231) - Box Set	PACK*100	£16.25

### Pierced (Diagram 224)



- Swiss Made

Code	Description	UOM	Price
S37404	Pierced (Diagram 224)	PACK*100	£13.80

**Pierced, (Diagram 235) - Box Set**



- Swiss Made
- Set Includes:
- Ø0.70mm
- Ø0.80mm
- Ø0.90mm
- Ø1.00mm
- Ø1.45mm
- Ø1.50mm
- Ø1.60mm
- Ø1.65mm
- Ø1.70mm
- Ø1.80mm

Code	Description	UOM	Price
S37408	Pierced, (Diagram 235) - Box Set	PACK*100	£15.95

**Blind (Diagram 233) - Box Set**



- Swiss Made
- Set Includes:
- Ø1.30mm
- Ø1.50mm
- Ø1.60mm
- Ø1.80mm
- Ø2.00mm
- Ø2.20mm
- Ø2.40mm
- Ø2.60mm
- Ø2.80mm
- Ø3.00mm

Code	Description	UOM	Price
S37412	Blind (Diagram 233) - Box Set	PACK*100	£21.10

- Ø0.80mm
- Ø0.90mm
- Ø1.00mm
- Ø1.45mm
- Ø1.50mm
- Ø1.60mm
- Ø1.65mm
- Ø1.70mm
- Ø1.80mm

Code	Description	UOM	Price
S37409	Pierced (Diagram 230)	PACK*100	£17.85

**Pierced (Diagram 235) - Tapered**



- Swiss Made

Code	Description	UOM	Price
S37414	Pierced (Diagram 235) - Tapered	PACK*100	£15.95

**Nickel, Blind & Pierced**

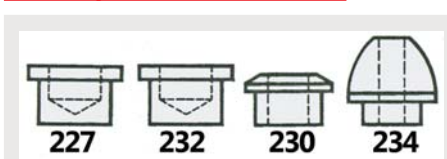

Special Profile (Universal) Clock Bushes - Size to your requirements - Nickel

- Unfinished
- Shape to your needs
- Blind - Non-drilled
- Pierced - Drilled

**Pierced (Diagram 234) - Tapered**



- Swiss Made

Code	Description	UOM	Price
S37413	Pierced (Diagram 234) - Tapered	PACK*100	£18.75



**Bronze, Blind**

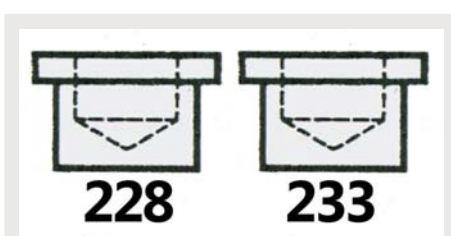

Special Profile (Universal) Clock Bushes - Size to your requirements - Bronze

- Unfinished
- Shape to your needs
- Blind - Non-drilled

**Blind (Diagram 227)**



- Swiss Made

Code	Description	UOM	Price
S37406	Blind (Diagram 227)	PACK*100	£11.55

**Blind (Diagram 232) - Box Set**



- Swiss Made

Code	Description	UOM	Price
S37411	Blind (Diagram 232) - Box Set	PACK*100	£17.55

**Pierced (Diagram 230)**



- Swiss Made
- Set Includes:
- Ø0.70mm

**Alignment, Levelling & Stabilizing Anchors**

Clock Case Alignment, Levelling & Stabilizing Anchors

For fine adjustment to wall clock cases against walls to align, level or to stabilize

- Black with Brass Screw Heads
- Brass with Black Screw Heads
- Centre Fixing (CF)

**Case to Wall Leveller, Black, Made in Germany**

Vienna Regulator / Wall Clock - Case to Wall Leveller

For wall clocks, blackened steel plate with steel screw, knurled brass head.

- Case leveller, alignment anchor and screw, per pair
- Black steel stabilizers with brass head screws
- Made in Germany



- Dimensions:
- Plate: 50 x 14 x 1.6mm
  - Screw: M3.5 x 19 mm

Code	Description	UOM	Price
C0341	Case to Wall Leveller, Black, Made in Germany	PAIR	£13.75

HSS Twist Drills, UK Made

See Page 835

BROWSE & BUY

**Case to Wall Leveller, Black (economy)**

Vienna Regulator / Wall Clock - Case to Wall Leveller



For wall clocks, blackened steel plate with steel screw, knurled brass head.

- Case leveller, alignment anchor and screw
- Black steel stabilizer with brass head screw
- Indian made for economy clocks

Dimensions:

- Plate: 40 x 14\* x 1.5mm (widest point)
- Screw: Ø9.5mm

Code	Description	UOM	Price
C31298	Case to Wall Leveller, Black (economy)	EACH	£1.60

**Case to Wall Leveller, Brass**

Vienna Regulator / Wall Clock - Case to Wall Leveller



For wall clocks, brass plates with knurled head black steel screw.

- Case leveller, alignment anchor and screw, per pair
- Brass stabilizers with folded head, black steel screws
- Made in Germany

Dimensions:

- Plate: 57 x 14 x 1mm
- Screw: M3 x 18 mm

Code	Description	UOM	Price
C0343	Case to Wall Leveller, Brass	PAIR	£14.95

**Case Fixing with Brass Body and Brass Button**

Vienna Regulator / Wall Clock - Case to Wall Leveller



For wall clocks, brass plate with steel screw, knurled brass head.

- Case leveller, alignment anchor and screw
- Brass stabilizer with brass head screw
- Indian made for economy clocks

Dimensions:

- Plate: 50 x 13 x 2mm
- Screw: Ø19mm

Code	Description	UOM	Price
C31299	Case Fixing with Brass Body and Brass Button	EACH	£1.95

**Case to Wall Leveller (CF)**

Vienna Regulator / Wall Clock - Case to Wall Leveller



For small wall clocks, blackened steel plate with steel screw, knurled brass head, centre fixing.

- Centre Fixing (CF)
- Case leveller, alignment anchor and screw
- Black steel stabilizers with brass head screw
- Indian made for economy clocks

Dimensions:

- Plate: 40 x 10 x 1mm
- Screw: Ø9.5mm

Code	Description	UOM	Price
C31297	Case to Wall Leveller (CF)	EACH	£1.45

**Mounting Brackets (Clock to Wall)**

**Clock Case Wall Mounting Brackets**



- 12 assorted
- Brass
- Hanger Plates
- For Wall Clocks
- Small, Medium & Large

Code	Description	UOM	Price
C5339	Clock Case Wall Mounting Brackets	EACH	£1.95

**Mounting Bracket (Movement to Case)**

**Clock Movement To Case Mounting Bracket**

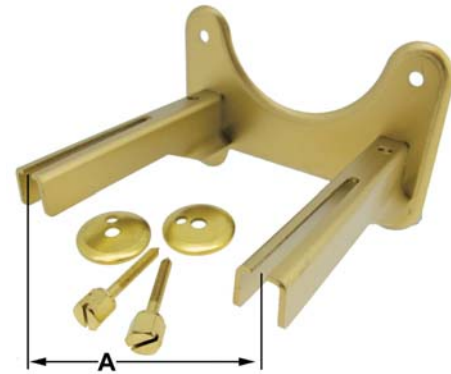

- 68mm Fixing Distance at 'A'
- Brass Finish with fittings.

Code	Description	UOM	Price
M9599	Clock Movement To Case Mounting Bracket	EACH	£22.95

**68mm (A) Mounting Bracket, Adjustable**

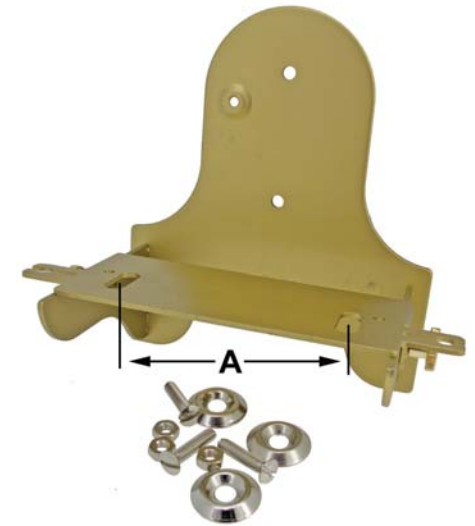

- 68mm Fixing Distance at 'A' (depth 70mm)
- Brass Finish with fittings.
- Adjustable Fittings

For regulator style clock movements. Made in bronzed metal and featuring adjustable - universal locating seat plate. Note: Although designed as a fixture in clock construction, this support could function as an economical wall mounted test bed for pendulum movements.

Code	Description	UOM	Price
M8306	68mm (A) Mounting Bracket, Adjustable	EACH	£22.95

**110mm (A) Mounting Bracket**

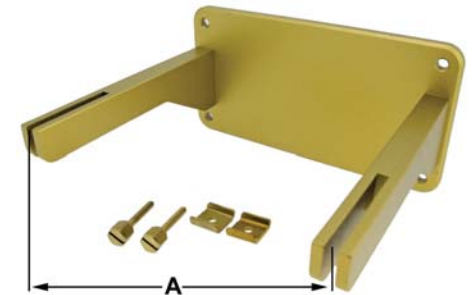

- 110mm Fixing Distance at 'A'
- Brass Finish with fittings

Code	Description	UOM	Price
M9600	110mm (A) Mounting Bracket	EACH	£22.95

**Movement Strap**

French Clock - Movement Strap

Brass straps for retaining French clock movements. Made 140mm long to allow for shortening.

- Brass
- 140mm (5.5") Long

**French Clock Movement Strap**



- Brass
- 140mm (5.5") Long



Clock Case Screws Assorted

See Page 1352

• Made in India

Code	Description	UOM	Price
L39710	French Clock Movement Strap	EACH	£2.50

**French Clock - Movement Strap**



- Brass
- 140mm (5.5") Long
- Made in UK

Code	Description	UOM	Price
F0670	French Clock - Movement Strap	EACH	£3.25

**Movement to Seatboard Fixings**

Clock Movement to Seatboard Fixing

Used to secure movements to the clocks' seat boards

- Centre Fixing or Hook
- Hooks Ø3.2 or 4.0mm

**Ø3.2mm (1/8") Seat Board Hook, UK Made**



- For Long Case Clocks
- Ø3.2mm (1/8")
- Made in UK

Code	Description	UOM	Price
L0924	Ø3.2mm (1/8") Seat Board Hook, UK Made	EACH	£1.30

**Ø4.0mm (5/32") Seat Board Hook**



- For Long Case Clocks
- Ø4.0mm (5/32")
- Made in India

Code	Description	UOM	Price
L39711	Ø4.0mm (5/32") Seat Board Hook	EACH	£0.95

**Ø4.0mm (5/32") Seat Board Hook**



- For Long Case Clocks
- Ø4.0mm (5/32")
- Made in UK

Code	Description	UOM	Price
L34545	Ø4.0mm (5/32") Seat Board Hook	EACH	£1.35

**Centre Screw Seatboard Fitting**

Clock Movement to Seatboard Fixing

For mounting regulator and longcase clock movements to seat boards or brackets.

- Steel screw & plate
- Screw thread diameter Ø2.90mm
- Screw overall length 50mm
- Washer 20 x 55mm
- Made in China



Code	Description	UOM	Price
M46057	Centre Screw Seatboard Fitting	EACH	£1.95

**Centre Screw Seatboard Fitting, Made in Germany**



Clock Movement to Seatboard Fixing

For mounting regulator and longcase clock movements to seat boards or brackets.

- Nickel plated screws and plates
- 32mm span
- Supplied per pair
- Dimensions 54mm x 14mm
- Screw thread diameter Ø2.90mm
- Screw overall length 39mm
- Made in Germany

Code	Description	UOM	Price
C0342	Centre Screw Seatboard Fitting, Made in Germany	PAIR	£12.25
Price breaks available, see website			

**CASE DECORATION, FURNITURE & FIXINGS**

**CASE BACK**

**Clock Case Back**

Clock Case Back - Ø110mm - Metal

- Clock case back for wall clocks
- Ø110mm
- Weight: 45g



Code	Description	UOM	Price
W36109	Clock Case Back, Metal	EACH	£1.95



**ORDER tracking**



**Online Discounts**

**CASE FEET**

**Ball Feet**



Clock Case - Ball Feet

- Solid Brass
- Polished and lacquered.
- With wood screw
- Made in E.U

Diameters:

- Ø13mm
- Ø19mm
- Ø25mm

Code	Description	UOM	Price
E5129	Ø13mm Brass Ball Foot	EACH	£2.95
E5128	Ø19mm Brass Ball Foot	EACH	£3.45
E5127	Ø25mm Brass Ball Foot	EACH	£3.95
Price breaks available, see website			

**Bun Feet**



Clock Case - Bun Feet

- Polished Brass
- Solid, high Quality
- With countersunk hole
- Made in UK
- Height 12mm

Diameters:

- Ø16, 20, 25, 30 & 32mm

Code	Description	UOM	Price
E5218	Ø16mm Brass Bun Foot	EACH	£4.50
E5217	Ø20mm Brass Bun Foot	EACH	£5.50
E5216	Ø25mm Brass Bun Foot	EACH	£5.70
E5215	Ø30mm Brass Bun Foot	EACH	£5.95
E5214	Ø32mm Brass Bun Foot	EACH	£6.25

**Corner Foot (19mm & 25mm), Claw**

Clock Case - Corner Claw Foot - Ornate

- 15mm high x 19mm (A)
- 20mm high x 25mm (A)
- Solid brass
- Sculptured claw foot design for corner mounting
- Inset mount platform
- Made in E.U

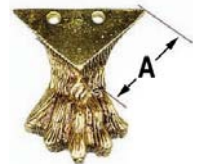

Code	Description	UOM	Price
E9853	19mm (A) Clock Case Claw Foot	EACH	£6.30
E9854	25mm (A) Clock Case Claw Foot	EACH	£7.95

**WORLDWIDE DELIVERY**



**Corner Foot (22mm), Ornate**

Clock Case - Corner Foot - Ornate

- Brass plated
- Length 22mm
- Height 12mm

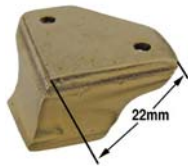

Code	Description	UOM	Price
E32052	Clock Case Ornate Corner Foot	EACH	£3.15

**Corner Foot (Ø30mm), Ornate**

Clock Case - Corner Foot - Ornate

- Satin Brass plated Gilded Finish
- (A) = 30mm
- (B) = 54mm
- Height 45mm

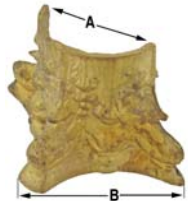

Code	Description	UOM	Price
E32046	Corner Foot (Ø30mm), Ornate	EACH	£4.60

**Corner Foot (30mm), Ornate**

Clock Case - Corner Foot - Ornate

- (A) = 30mm
- Brass - lacquered
- Height 12mm
- Made in E.U



Code	Description	UOM	Price
E5132	Corner Foot (30mm), Ornate	EACH	£5.10
Price breaks available, see website			

**Corner Foot (38mm), Ornate**

Clock Case - Corner Foot - Ornate

- (A) = 38mm
- Brass - lacquered
- Height 15mm
- Made in E.U

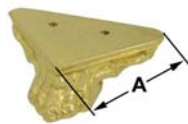

Code	Description	UOM	Price
E5130	Corner Foot (38mm), Ornate	EACH	£3.95

**Corner Foot (40mm), Ornate**

Clock Case - Corner Foot - Ornate

- (A) = 40mm
- Brass - lacquered
- Height 14mm
- Made in E.U

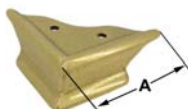

Code	Description	UOM	Price
E5131	Corner Foot (40mm), Ornate	EACH	£5.25
Price breaks available, see website			

**Corner Foot (50mm), Ornate**

Clock Case - Corner Foot - Ornate

- Brass plated
- Length 50mm
- Height 30mm



Code	Description	UOM	Price
E32053	Corner Foot (50mm), Ornate	EACH	£4.10

**CASE DECORATIONS (BRASS)**



For restoring and decorating new and old clock cases, cabinets, furniture, etc. including clock dial decoration & embellishment.

- Acorns
- Balls
- Finials
- Garlands (Bow)
- Garlands (Wreath)
- Rosettes (with Holes)
- Rosettes (with Pin)

**Acorns**



Clock Case - Ornamental Turrets - Acorns

- High quality cast brass
- Polished and lacquered
- With inserted wood screw
- Decorative Case Embellishment

Dimensions: Diameter x (Height) without screw

\*Made in E.U

Code	Description	UOM	Price
E5126	Ø14mm (26mm) Acorn*	EACH	£4.95
E5125	Ø18mm (37mm) Acorn*	EACH	£5.50
E5124	Ø22mm (48mm) Acorn*	EACH	£14.50
E32051	Ø42mm (72mm) Acorn	EACH	£9.70

**Balls with Fixing Screw**



Clock Case - Decorative Balls

- Turned, Polished and Varnished
- With fixing screw
- Decorative Case Embellishment
- Made in Germany

Sizes: Diameter x Height x Thread

- Ø7mm x 9mm x M3
- Ø10mm x 9mm x M3
- Ø12mm x 15mm x M4
- Ø15mm x 15mm x M4

Code	Description	UOM	Price
E32063	Ø7mm Brass Ball & Screw	EACH	£1.45
E32064	Ø10mm Brass Ball & Screw	EACH	£1.50
E0507	Ø12mm Brass Ball & Screw	EACH	£1.95
E0508	Ø15mm Brass Ball & Screw	EACH	£2.25

**Finials (Urn Style)**

Clock Case - Ornamental Turrets - Finials (Urn Style)

- Solid Brass
- High quality
- Polished and lacquered
- With inserted wood screw
- Decorative Case Embellishment
- Made in E.U



Dimensions: Diameter x (Height) without screw

Code	Description	UOM	Price
E8320	Ø19mm (36mm) Finial	EACH	£6.30
E8321	Ø24mm (48mm) Finial	EACH	£7.95

**Garlands (Bow)**



Clock Case - Ornamental Garlands - Bow

- Solid brass bow tied ribbon design
- Superb detailing
- High quality cast brass
- Polished and lacquered
- Decorative case embellishment

Dimensions: Length x (Height)

Code	Description	UOM	Price
E9856	54mm (13mm) Garland	EACH	£5.30
E9857	70mm (18mm) Garland	EACH	£6.60

**TODAY SAME DAY DISPATCH**

**SECURE ONLINE ORDERING**



**Garland (Wreath)**



Clock Case - Ornamental Garlands - Wreath

- Solid brass wreath & tied ribbon design
- Superb detailing
- High quality cast brass
- Polished and lacquered
- Decorative case embellishment

Dimensions: Length x (Height)

Code	Description	UOM	Price
E9858	21mm (19mm) Garland	EACH	£4.80
E9859	55mm (18mm) Garland	EACH	£5.85
E9860	82mm (22mm) Garland	EACH	£6.25

**Rosettes (centre hole)**



Clock Case - Ornamental Rosettes - Centre Fixing hole

- Brass
- Hollow embossed
- Polished and lacquered
- With nail fixing centre hole
- Decorative case embellishment
- Made in E.U

Code	Description	UOM	Price
E5134	Rosette/Patera Ø17mm	EACH	£1.50
E5135	Rosette/Patera Ø25mm	EACH	£1.60
E8326	Rosette/Patera Ø25mm, Floret	EACH	£2.60
E32048	Rosette/Patera Ø38mm	EACH	£2.95

**Rosettes (centre holes)**



Clock Case - Ornamental Rosettes - Outer Fixing holes

- Brass
- Hollow embossed
- Polished and lacquered
- With outer nail fixing holes
- Decorative case embellishment
- Made in E.U

Code	Description	UOM	Price
E5136	Ø35mm Rosette	EACH	£3.85
E8325	37 x 20mm Rosette	EACH	£3.95
E5133	Ø48mm Rosette	EACH	£6.50

**Rosettes (with pin)**

Clock Case - Ornamental Rosettes - with Pin

- Brass
- Hollow embossed
- Polished and lacquered
- With pin fixing
- Decorative case embellishment
- Made in E.U



Code	Description	UOM	Price
E8330	Ø14mm Rosette with Pin	EACH	£1.95
E8329	Ø17mm Rosette with Pin	EACH	£1.95
E8328	Ø23mm Rosette with Pin	EACH	£2.25
E8327	Ø30mm Rosette with Pin	EACH	£2.85

Price breaks available, see website

**CASE DECORATIONS (WOODEN)**



For restoring and decorating new and old clock cases, cabinets, furniture, etc. These parts are pressed, raw and can be stained, varnished & painted. Wood finish and patterns may vary.

- Button / Disks
- Cameos
- Commas
- Rosettes (Round)
- Rosettes (Square)
- Scrolls
- Spandrel Corners
- Spandrels

**Button Domes**

Clock Case - Button Ornament - Wood Pattera Ø14mm

- Wood Pattera Ø14mm
- Domed
- Flat back
- Made in Germany



Code	Description	UOM	Price
E8243	Ø14mm Button Ornament	EACH	£1.25

**Button Domes with Lip**

Clock Case - Button Ornament - Wood Pattera Ø20mm

- Wood Pattera Ø20mm
- Domed
- Flat back
- 4 pieces per pack
- Made in Germany



Code	Description	UOM	Price
E8244	Ø20mm Button Ornament	PACK*4	£2.81

**Disk Button Ø33mm**

Clock Case - Button Ornament - Wood Pattera Ø33mm

- Wood Pattera Ø33mm
- Domed
- Flat back
- Made in Germany



Code	Description	UOM	Price
E8245	Disk Button Ø33mm	EACH	£2.50

**Disk Button Ø52mm**

Clock Case - Button Ornament - Wood Pattera Ø52mm

- Wood Pattera Ø52mm
- Raised contour
- Flat back
- 1 pieces per pack
- Made in Germany



Code	Description	UOM	Price
E8246	Disk Button Ø52mm	EACH	£6.25

**Cameo Head**

Clock Case - Cameo (Head) - Wood Cast

- Wood Cast Cameo
- Raised contour
- Flat back
- 1 pieces per pack



Dimensions: Height x Width x Depth

- Height 51mm
- Width 38mm
- Depth 20mm

Code	Description	UOM	Price
E8240	51 x 38 x 20mm Cameo	EACH	£5.75

**Cameo Head on Plaque**

Clock Case - Cameo (Head on Plaque)

- Wood Cast Cameo
- Raised contour
- Flat back
- 1 pieces per pack



Dimensions: Height x Width x Depth

- Height 60mm
- Width 51mm
- Depth 12mm

Code	Description	UOM	Price
E8241	Cameo (Head on Plaque)	EACH	£6.25



Vallorbe Swiss Files

See Page 853

**Rosette Pattera, Round**



Clock Case - Rosette (Round) Ornament - Wood Pattera

- Wood Pattera
- Keenly detailed
- Floret Raised Pattern
- Flat back
- 1 pieces per pack
- Made in Germany

Dimensions: Ø22mm, Ø33mm & Ø43mm

Code	Description	UOM	Price
E8281	Ø22mm Wood Rosette	EACH	£3.50
E8284	Ø33mm Wood Rosette	EACH	£4.25
E8286	Ø43mm Wood Rosette	EACH	£4.45

Price breaks available, see website

**Rosette Pattera, Round**

Clock Case - Rosette (Round) Ornament - Wood Pattera

- Wood Pattera
- Keenly detailed
- Floret Raised Pattern
- Flat back
- 1 pieces per pack
- Made in Germany



Dimensions: Ø60mm

Code	Description	UOM	Price
E8287	Ø60mm Wood Rosette	EACH	£4.25

**Rosette Pattera, Square**

Clock Case - Rosette (Square) Ornament - Wood Pattera

- Wood Pattera
- Keenly detailed
- Floret Raised Pattern
- Flat back
- 1 pieces per pack
- Made in Germany



Dimensions: 34mm x 34mm

Code	Description	UOM	Price
E8285	34mm Wood Rosette	EACH	£4.15

Price breaks available, see website

**Rosette Pattera, Square**

Clock Case - Rosette (Square) Ornament - Wood Pattera

- Wood Pattera
- Keenly detailed
- Floret Raised Pattern
- Flat back
- 1 pieces per pack
- Made in Germany



Dimensions: 49mm x 49mm

Code	Description	UOM	Price
E8283	49mm Wood Rosette	EACH	£4.35

**Scrolls, Comma**



Clock Case - Wooden Ornate Comma

- Wood Ornate decorative Comma design
- Smooth Finish
- Decorative case embellishment
- Supplied in Pairs

Dimensions:  
• Length 50mm  
• Height 17mm  
• Depth 3mm

Code	Description	UOM	Price
E8248	Wooden Ornate Comma	PAIR	£2.20

**Scrolls, Ornate**



Clock Case - Wooden Ornate Scroll

- Wood Ornate decorative Scroll
- Smooth Finish
- Decorative case embellishment
- Supplied in Pairs

Dimensions:  
• Length 57mm  
• Wide 20mm  
• Depth 5mm

Code	Description	UOM	Price
E8251	Scroll (Ornate) 57mm	PAIR	£10.55

**Scrolls, Fancy**



Clock Case - Wooden Ornate Scroll

- Wood Ornate decorative Scroll
- Smooth Finish
- Decorative case embellishment
- Supplied in Pairs

Dimensions:  
• Length 115mm  
• Wide 30mm  
• Depth 3mm

Code	Description	UOM	Price
E8249	Scroll (Ornate) 115mm	PAIR	£4.25

**Spandrel 58 x 58mm**

Clock Case - Wooden Corner Spandrel

- Wood Ornate Spandrel
- Smooth Carved Finish
- Decorative case embellishment
- 1 piece per pack



Dimensions:  
• Lengths: 58 x 58 x 80mm  
• Depth: 10mm

Code	Description	UOM	Price
E8242	Spandrel (Wood)	EACH	£7.95

**Spandrel 100 x 65mm**



Clock Case - Wooden Ornate Corner

- Wood Ornate decorative Corner
- Smooth Finish
- Decorative case embellishment
- Supplied in Pairs

Dimensions:  
• Length 100mm  
• Length 65mm  
• Depth 7mm

Code	Description	UOM	Price
E8247	Wooden Ornate Corner	PAIR	£13.95

**DOOR PULLS, HANDLES, KNOBS & LATCHES**

**Bracket & Carriage Clock Handles**

**26mm Fitting Handle**

Clock Case Handle - Ornate eagle

- Polished Brass
- Fittings
- Fitting screws: Ø3.80 x 55mm
- Made in Spain

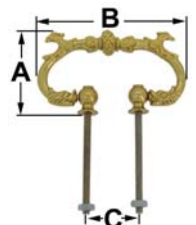

Dimensions:  
• A = 44mm  
• B = 74mm  
• C = 26mm

Code	Description	UOM	Price
E5138	26mm Fitting Clock Case Handle	EACH	£9.45

**29mm Fitting Handle**

Clock Case Handle - Plain Style

- Polished Brass
- Fittings
- Fitting screws: Ø3.00 x 55mm
- Made in Spain

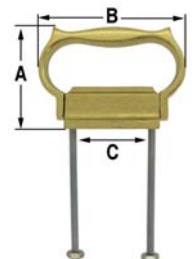

Dimensions:  
• A = 40mm  
• B = 55mm  
• C = 29mm

Code	Description	UOM	Price
E5142	29mm Fitting Clock Case Handle	EACH	£10.85



**ORDER tracking**



**WORLDWIDE DELIVERY**



**Online Discounts**

### 35mm Fitting Handle

Clock Case Handle - Ornate

- Polished Brass
- Fittings
- Fitting screws: Ø3.80 x 55mm
- Made in Spain

Dimensions:

- A = 40mm
- B = 95mm
- C = 35mm

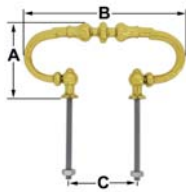

Code	Description	UOM	Price
E5137	35mm Fitting Clock Case Handle	EACH	£11.95

### Centre Fitting Handle, Ornate

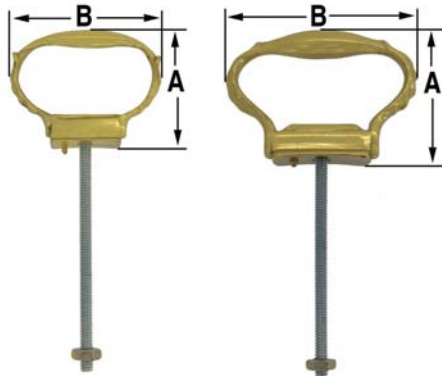

Clock Case Handle - Centre Fitting - Ornate

Bracket clock fixed handle with locating pin plus central threaded stud and nut for securing to case.

- Solid Brass
- Polished and Lacquered
- Fittings
- Patterned Style
- Fitting screw: Ø3.00 x 55mm

Dimensions:

- A = Handle Height
- B = Handle Width

Code	Description	UOM	Price
H9844	A = 29mm x B = 37mm Handle	EACH	£7.95
H9845	A = 34mm x B = 47mm Handle	EACH	£8.65

### Centre Fitting Handle, Plain

Clock Case Handle - Centre Fitting - Plain

Bracket clock fixed handle with locating pin plus central threaded stud and nut for securing to case.

- Solid Brass
- Polished and Lacquered
- Fittings
- Fitting screw: Ø3.80 x 55mm
- Plain Style

Dimensions:

- A = Handle Height
- B = Handle Width

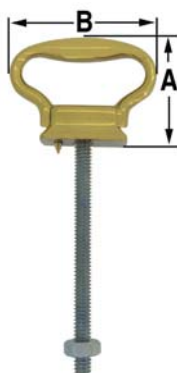

Code	Description	UOM	Price
H9846	A = 25mm x B = 33mm Handle	EACH	£7.20
H9847	A = 32mm x B = 40mm Handle	EACH	£7.90
H9848	A = 40mm x B = 53mm Handle	EACH	£16.30

## Door & Furniture Handles

Brass handles for clock cases, cabinets and furniture with draws etc.

### Gothic Style Handles

Clock Case - Gothic Ring Handles

Solid brass gothic style sculptured and swivelling handle on 16mm round mount with wood screw.

- Solid Brass
- Polished Finish
- Gothic
- Swivelling Handle
- 31mm & 47mm Handle Width (span)

Code	Description	UOM	Price
E9861	31mm Gothic Ring Handle	EACH	£6.05
E9862	47mm Gothic Ring Handle	EACH	£9.30



### Ring Pull Style

Clock Case - Ring Pull Handles

Solid brass circular "ring pull" swivelling handle on a round floret style mount with fitting for table / bracket clock sides.

- Solid Brass
- Polished Finish
- Ring Pull Style
- Swivelling Handle
- Ø30mm & 40mm Ring Pull Diameter

Code	Description	UOM	Price
H9849	Ø30mm Ring Pull Handle	EACH	£4.15
H9850	Ø40mm Ring Pull Handle	EACH	£5.80



### Lion Head Style

Clock Case - Lion Head - Ring Pull - Handle

- Solid brass with smooth ring
- Height 40mm
- Width 30mm
- Lion and mane head ornate base mount
- 25mm swivelling ring through mouth of mount

Code	Description	UOM	Price
H9852	Lion Head, Ring Pull Handle	EACH	£10.30



### Lion Head Style

Clock Case - Lion Head - Ring Pull - Handle

- Solid brass with smooth ring
- Height 39mm
- Width 41mm
- Lions head ornate base mount
- 36mm swivelling ring through the Lions mouth



Code	Description	UOM	Price
H9851	Lion Head, Ring Pull Handle	EACH	£14.65

## Door Knobs & Latches

### Carriage Clock Style

Clock Case - Door Knobs - Carriage Clock

- Brass
- Knurled Head Ø6.4mm
- Thread 8BA
- Thread Length 6.4mm

Code	Description	UOM	Price
E5219	Carriage Clock Door Knob	EACH	£2.65



### General Clock Style

Clock Case - Door Knob - General

- Brass
- No Mount
- Screw Fit
- Knob Ø13mm or 20mm

Code	Description	UOM	Price
E0510	Ø13mm Door Pull	EACH	£1.00
E0511	Ø20mm Door Pull	EACH	£1.10



### Long Case Style

Clock Case - Door Knobs - Long Case Hood

- Screw Fit
- Brass
- Decorative Profile
- Threaded & Polished
- Largest Ø12.6mm
- Length (excluding thread) 14.6mm
- Thread Length 8.5mm

Code	Description	UOM	Price
L34539	Long Case Hood Door Knob	EACH	£1.75



Online Discounts

COUSINSUK  
A WEALTH OF INFORMATION

CUSTOMER SERVICE  
SECOND TO NONE

COUSINSUK  
USE US FOR YOUR ADVANTAGE



### Door Latch, Hook & Eye

Clock Case - Door Latch, Hook & Eyes

Choice of three length to suit Small, medium & large clock Cases.

- Brass
- Door Hook & Eye
- Fixing Screw & Washer
- Packs of 2
- Made in Germany



Code	Description	UOM	Price
E7781	11mm Door Latch/Hook & Eye	PACK*2	£2.10
E7782	17mm Door Latch/Hook & Eye	PACK*2	£2.95
E7783	22mm Door Latch/Hook & Eye	PACK*2	£3.40
D46056	Ø8mm Door Latch Hook Eye	PACK*5	£0.85

### Door Latch & Swivel

Clock Case - Door Latch & Swivel

- Brass
- Ø13mm Knob
- Steel Shaft
- Brass Swivel Tongue



Dimensions: Maximum Door Thickness

Code	Description	UOM	Price
E9823	10mm Door Latch & Swivel	EACH	£1.75
E9824	14mm Door Latch & Swivel	EACH	£1.75
E9825	17mm Door Latch & Swivel	EACH	£1.75
E9826	23mm Door Latch & Swivel	EACH	£1.75

## Drop Door Pulls

### Gothic Style

Clock Case - Door Pull - Gothic

- Brass
- Gothic Style
- Antique Lacquered Finish
- Choice of 16 or 24mm Width (span)



Code	Description	UOM	Price
E8316	16mm Gothic Door Pull	EACH	£5.65
E8315	24mm Gothic Door Pull	EACH	£5.55

### Antique Style

Clock Case - Door Pull (Drop) - Antique

- Brass
- Drop Pendant Type
- Antique Lacquered Finish
- Screw Fit
- Drop Length 30mm



Code	Description	UOM	Price
E8314	Door Pull (Drop) Antique	EACH	£4.20

### Antique Style with Locating Plate

Clock Case - Door Pull (Drop) - Antique with Horizontal Locating Plate

- Brass
- Antique Lacquered Finish
- Pendant Drop with Locating Plate
- Screw Fit
- Drop Length 25mm



Code	Description	UOM	Price
E8313	Door Pull (Drop) Antique	EACH	£5.55

### Antique Style with Locating Plate

Clock Case - Door Pull (Drop) - Antique with Vertical Locating Plate

- Brass
- Antique Lacquered Finish
- Pendant Drop with Locating Plate
- Screw Fit
- Size: 20 x 39 mm



Code	Description	UOM	Price
E0509	Door Pull (Drop) Antique	EACH	£6.85

## EAGLES WITH BALLS & SPIRES

### Eagle & Ball

Clock Case - Eagle & Ball Ornament

- Ø48mm x 110mm Height
- Polished and lacquered
- With inserted wood screw
- Hollow Sphere
- Cast Eagle



Dimensions: Ball Ø x Height (excluding Screw)

Code	Description	UOM	Price
E32029	Ø48mm x 110mm Eagle & Ball	EACH	£10.90

### Eagle

Clock Case - Eagle Ornament

- Ø51mm (span) x 52mm Height
- Polished and lacquered
- With inserted wood screw
- Cast Eagle
- Made in E.U



Dimensions: Wing Span x Height (excluding Screw)

Code	Description	UOM	Price
E5123	51mm (span) x 52mm Eagle	EACH	£5.95

### Spire & Ball



Clock Case - Spire & Ball Ornament

- Ø25 to Ø66mm
- Polished and lacquered
- With inserted wood screw
- Hollow Sphere with Spire

Dimensions: Ball Ø x (Height) excluding Screw

\* UK Made  
\*\* EU Made  
\*\*\* Indian

Code	Description	UOM	Price
E5121	Ø25mm (75mm) Spire & Ball**	EACH	£11.95
E34540	Ø42mm (105mm) Spire & Ball*	EACH	£18.45
E5119	Ø45mm (117mm) Spire & Ball**	EACH	£13.95
E31308	Ø50mm (112mm) Spire & Ball***	EACH	£9.95
E34541	Ø55mm (120mm) Spire & Ball*	EACH	£22.95
E34542	Ø56mm (120mm) Spire & Squat Ball*	EACH	£22.95
E5122	Ø60mm (122mm) Spire & Ball**	EACH	£20.95
E34543	Ø66mm (145mm) Spire & Ball*	EACH	£23.25

### Eagle & Ball

Clock Case - Eagle & Ball Ornament

- Ø45mm x 115mm Height
- Polished and lacquered
- With inserted wood screw
- Hollow Sphere
- Solid Cast Eagle
- Made in E.U



Dimensions: Ball Ø x Height (excluding Screw)

Code	Description	UOM	Price
E5120	Ø45mm x 115mm Eagle & Ball	EACH	£11.50

+

Contact & Services

Your direct line to our Management Team

Instant Message Service

COUSINSUK PRICE PROMISE

## ESCUTCHEONS (KEY HOLES)

### 12mm Oval Brushed Brass

Clock Case - Ornamental  
Keyhole Escutcheon - Plate

- Oval plain brass
- Polished & satin lacquered
- Decorative case embellishment
- Dimensions: 24 x 12 mm



Dimensions: Overall Width x Height

Code	Description	UOM	Price
E8318	Keyhole Escutcheon Plate	EACH	£1.25

### 13mm Insert Polished Brass

Clock Case - Ornamental  
Keyhole Insert

- Flanged plain brass
- Polished & lacquered
- Decorative case embellishment
- Made in E.U or India



Dimensions:

- Overall Dimensions: 13 x 22 mm
- Insert size approx: 10 x 18mm

Code	Description	UOM	Price
E45740	Keyhole Insert	EACH	£2.50
E8312	Keyhole Insert, Brass	EACH	£4.75

Price breaks available, see website

### 40mm Ornate

Clock Case - Ornamental  
Keyhole Escutcheon - Plate

- Ornate fancy plate
- Polished Brass
- Decorative case embellishment
- 40 x 20mm
- Made in E.U or India



Code	Description	UOM	Price
E45741	Key Hole Escutcheon	EACH	£2.50
E43310	Key Hole Escutcheon, E.U	EACH	£3.50

Price breaks available, see website

### 40mm Ornate Antique Satin

Clock Case - Ornamental  
Keyhole Escutcheon - Plate

- Ornate fancy plate
- Antique satin lacquered
- Decorative case embellishment
- 40 x 20mm
- Made in E.U



Code	Description	UOM	Price
E8317	Keyhole Escutcheon, Fancy	EACH	£3.30

Price breaks available, see website

### 55mm Gothic Satin Antique

Clock Case - Ornamental  
Keyhole Escutcheon - Gothic

- High quality brass
- Gothic style
- Antique satin lacquered brass
- Decorative case embellishment

Dimensions: Overall Length x Width



Code	Description	UOM	Price
E8319	Keyhole Escutcheon (55mm)	EACH	£6.60

### 60mm Serpentine Brushed Brass

Clock Case - Ornamental  
Keyhole Escutcheon - Fancy  
Pattern

- High quality brass
- Brushed finish
- Polished and lacquered
- Decorative case embellishment

Dimensions: Overall Length



Code	Description	UOM	Price
E5143	Keyhole Escutcheon (60mm)	EACH	£2.25

### 83mm Fleur de Lys Polished Brass

Clock Case - Ornamental  
Keyhole Escutcheon

- High quality cast brass
- Polished and lacquered
- Decorative case embellishment

Dimensions: Overall Length



Code	Description	UOM	Price
E32044	Keyhole Escutcheon (83mm)	EACH	£3.15

### 85mm Floral Polished Brass

Clock Case - Ornamental  
Keyhole Escutcheon

- High quality cast brass
- Polished and lacquered
- Decorative case embellishment

Dimensions: Overall Length



Code	Description	UOM	Price
E32045	Keyhole Escutcheon (85mm)	EACH	£3.15

## FINIALS



- Machine-Turned Wood Finials.
  - Ideal as replacements for missing parts on old clock cases or as ornaments for new cases, cabinets, etc.
  - Ready to be sanded and stained, varnished or bronzed.
  - Length without dowel
  - Wood finish may vary
- Dimensions: Diameter x Height

### Ø10 x 22mm Finial

Clock Case Wood Finial

- Ø10mm
- Height 22mm
- Beech
- Smooth (Ready) Finish
- Made in Germany



Dimensions are approximate

Code	Description	UOM	Price
E0514	Ø10 x 22mm Wood Finial	EACH	£1.50

Price breaks available, see website

### Ø20 x 30mm Finial

Clock Case Wood Finial

- Ø20mm
- Height 30mm
- Beech
- Smooth (Ready) Finish
- Made in Germany



Dimensions are approximate

Code	Description	UOM	Price
E8256	Ø20 x 30mm Wood Finial	EACH	£3.75

Price breaks available, see website

### Ø20 x 40mm Finial

Clock Case Wood Finial

- Ø20mm
- Height 40mm
- Beech
- Smooth (Ready) Finish
- Made in Germany



Dimensions are approximate

Code	Description	UOM	Price
E0515	Ø20 x 40mm Wood Finial	EACH	£4.25

Price breaks available, see website

**PRICE PROMISE  
GUARANTEE**

**Ø20 x 42mm Finial**

Clock Case Wood Finial

- Ø20mm
- Height 42mm
- Bottom dowel Ø6.5mm
- Beech
- Smooth (Ready) Finish
- Made in Germany

Dimensions are approximate



Code	Description	UOM	Price
<b>E0516</b>	Ø20 x 42mm Wood Finial	EACH	<b>£3.50</b>
Price breaks available, see website			

**Ø30 x 63mm Finial**

Clock Case Wood Finial

- Ø30mm
- Height 63mm
- Beech
- Smooth (Ready) Finish
- Made in Germany

Dimensions are approximate



Code	Description	UOM	Price
<b>E8272</b>	Ø30 x 63mm Wood Finial	EACH	<b>£7.25</b>
Price breaks available, see website			

**Ø34 x 57mm Finial**

Clock Case Wood Finial

- Ø34mm
- Height 57mm
- Beech
- Smooth (Ready) Finish
- Made in Germany

Dimensions are approximate



Code	Description	UOM	Price
<b>E8269</b>	Ø34 x 57mm Wood Finial	EACH	<b>£5.30</b>
Price breaks available, see website			

**Ø28 x 40mm Finial**

Clock Case Wood Finial

- Ø28mm
- Height 40mm
- Beech
- Smooth (Ready) Finish
- Made in Germany

Dimensions are approximate



Code	Description	UOM	Price
<b>E8265</b>	Ø28 x 40mm Wood Finial	EACH	<b>£3.85</b>
Price breaks available, see website			

**Ø31 x 60mm Finial**

Clock Case Wood Finial

- Ø31mm
- Height 60mm
- Beech
- Smooth (Ready) Finish
- Made in Germany

Dimensions are approximate



Code	Description	UOM	Price
<b>E8268</b>	Ø31 x 60mm Wood Finial	EACH	<b>£5.65</b>
Price breaks available, see website			

**Ø35 x 64mm Finial**

Clock Case Wood Finial

- Ø35mm
- Height 64mm
- Beech
- Smooth (Ready) Finish
- Made in Germany

Dimensions are approximate



Code	Description	UOM	Price
<b>E8266</b>	Ø35 x 64mm Wood Finial	EACH	<b>£6.50</b>
Price breaks available, see website			

**Ø29 x 72mm Finial**

Clock Case Wood Finial

- Ø29mm
- Height 72mm
- Beech
- Smooth (Ready) Finish
- Made in Germany

Dimensions are approximate



Code	Description	UOM	Price
<b>E0518</b>	Ø29 x 72mm Wood Finial	EACH	<b>£5.50</b>
Price breaks available, see website			

**Ø32 x 54mm Finial**

Clock Case Wood Finial

- Ø32mm
- Height 54mm
- Beech
- Smooth (Ready) Finish
- Made in Germany

Dimensions are approximate



Code	Description	UOM	Price
<b>E8273</b>	Ø32 x 54mm Wood Finial	EACH	<b>£6.75</b>
Price breaks available, see website			

**Ø36 x 64mm Finial**

Clock Case Wood Finial

- Ø36mm
- Height 64mm
- Beech
- Smooth (Ready) Finish
- Made in Germany

Dimensions are approximate



Code	Description	UOM	Price
<b>E0519</b>	Ø36 x 64mm Wood Finial	EACH	<b>£6.55</b>
Price breaks available, see website			

**Ø30 x 51mm Finial**

Clock Case Wood Finial

- Ø30mm
- Height 51mm
- Beech
- Smooth (Ready) Finish
- Made in Germany

Dimensions are approximate



Code	Description	UOM	Price
<b>E8263</b>	Ø30 x 51mm Wood Finial	EACH	<b>£3.95</b>
Price breaks available, see website			

**Ø33 x 49mm Finial**

Clock Case Wood Finial

- Ø33mm
- Height 49mm
- Beech
- Smooth (Ready) Finish
- Made in Germany

Dimensions are approximate



Code	Description	UOM	Price
<b>E0520</b>	Ø33 x 49mm Wood Finial	EACH	<b>£5.75</b>
Price breaks available, see website			

**Ø37 x 72mm Finial**

Clock Case Wood Finial

- Ø37mm
- Height 72mm
- Beech
- Smooth (Ready) Finish
- Made in Germany

Dimensions are approximate



Code	Description	UOM	Price
<b>E8267</b>	Ø37 x 72mm Wood Finial	EACH	<b>£6.95</b>
Price breaks available, see website			

**Shellac Pieces**

**See Page 1195**

**L&R Clock Cleaning Concentrate**

**See Page 1162**



**Ø38 x 74mm Finial**

Clock Case Wood Finial

- Ø38mm
- Height 74mm
- Beech
- Smooth (Ready) Finish
- Made in Germany

Dimensions are approximate



Code	Description	UOM	Price
<b>E8271</b>	Ø38 x 74mm Wood Finial	EACH	<b>£9.85</b>
Price breaks available, see website			

**Ø39 x 90mm Finial**

Clock Case Wood Finial

- Ø39mm
- Height 90mm
- Beech
- Smooth (Ready) Finish
- Made in Germany

Dimensions are approximate



Code	Description	UOM	Price
<b>E8274</b>	Ø39 x 90mm Wood Finial	EACH	<b>£8.90</b>
Price breaks available, see website			

**Ø40 x 79mm Finial**

Clock Case Wood Finial

- Ø40mm
- Height 79mm
- Beech
- Smooth (Ready) Finish
- Made in Germany

Dimensions are approximate



Code	Description	UOM	Price
<b>E8270</b>	Ø40 x 79mm Wood Finial	EACH	<b>£6.50</b>
Price breaks available, see website			

**Ø44 x 54mm Finial**

Clock Case Wood Finial

- Ø44mm
- Height 54mm
- Beech
- Smooth (Ready) Finish
- Made in Germany

Dimensions are approximate



Code	Description	UOM	Price
<b>E8275</b>	Ø44 x 54mm Wood Finial	EACH	<b>£5.75</b>
Price breaks available, see website			

**Ø44 x 76mm Finial**

Clock Case Wood Finial

- Ø44mm
- Height 76mm
- Beech
- Smooth (Ready) Finish
- Made in Germany

Dimensions are approximate



Code	Description	UOM	Price
<b>E8278</b>	Ø44 x 76mm Wood Finial	EACH	<b>£7.85</b>
Price breaks available, see website			

**Ø44 x 82mm Finial**

Clock Case Wood Finial

- Ø44mm
- Height 82mm
- Beech
- Smooth (Ready) Finish
- Made in Germany

Dimensions are approximate



Code	Description	UOM	Price
<b>E0521</b>	Ø44 x 82mm Wood Finial	EACH	<b>£10.95</b>
Price breaks available, see website			

**Ø48 x 52mm Finial**

Clock Case Wood Finial

- Ø48mm
- Height 52mm
- Beech
- Smooth (Ready) Finish
- Made in Germany

Dimensions are approximate



Code	Description	UOM	Price
<b>E8279</b>	Ø48 x 52mm Wood Finial	EACH	<b>£4.40</b>
Price breaks available, see website			

**Ø52 x 82mm Finial**

Clock Case Wood Finial

- Ø52mm
- Height 82mm
- Beech
- Smooth (Ready) Finish
- Made in Germany

Dimensions are approximate



Code	Description	UOM	Price
<b>E0522</b>	Ø52 x 82mm Wood Finial	EACH	<b>£11.50</b>
Price breaks available, see website			

**Emery Paper - SIA**

See Page 1145



**HINGES**

A range of hinges for clock case repairs and other uses in antique repair & restoration.

- Finial Joint
- Tradition (Small)
- Off Set (Antique Finish)
- Trunk (Long Case)
- Strap (Long Case)
- Hood Door Blanks (Long Case)

**Hinges with Finial Joint**



Clock Case Hinge with Finial Joint

- Brass
- Polished Satin Finish
- Lacquered
- Countersunk Holes
- 3 sizes
- Finial size 8mm
- Made in UK

Dimensions: Height (excluding finial) x Width

Code	Description	UOM	Price
<b>E8309</b>	40 x 35mm Hinge	EACH	<b>£7.30</b>
<b>E8310</b>	50 x 40mm Hinge	EACH	<b>£7.85</b>
<b>E8311</b>	60 x 40mm Hinge	EACH	<b>£8.20</b>

**Hinges, Small**



Clock Case Hinge Assorted - Small

- Brass
- Heights 13mm & 19mm (approx.)
- Assorted Sizes
- For music boxes, clock doors and cases

Code	Description	UOM	Price
<b>C5338</b>	Small Hinges Assorted	PACK*12	<b>£1.60</b>

**Hinges, Off Set**

Clock Case Hinge - Off Set

- Brass
- Antique Bronze Finish
- Lacquered
- Countersunk Holes
- Made in Germany



Dimensions:

- Height 45mm (when at the close position)
- Width 86mm (when at the open position, as photo)

Code	Description	UOM	Price
<b>E0506</b>	Clock Case Off Set Hinge	EACH	<b>£9.95</b>



### Hinges, Trunk

Long Case Clock - Trunk Hinge

A very high quality yellow cast Brass trunk hinge, manufactured from a traditional cast Brass alloy to give a totally convincing finish.

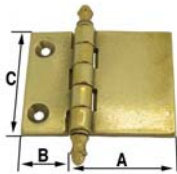

- Brass
- Finial Hinge
- Finial size 8mm
- Made in UK

Dimensions:

- A = 22mm
- B = 13mm
- C = 32mm

Code	Description	UOM	Price
E5221	Long Case Trunk Hinge	EACH	£19.65

### Hinges, Strap

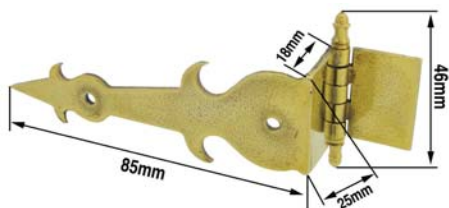

Long Case Clock - Strap Hinges - Gothic Style

- Strap Hinge
- Brass
- Gothic Style
- Finial Hinge
- Length 85mm
- Depth 25mm

Code	Description	UOM	Price
E5220	Long Case Strap Hinge	EACH	£34.95

### Hinges, Hood Door Blanks (Pre-drilled)

Long Case Clock - Hood Door Hinge Blanks - Pre-drilled

Hood door hinge blanks, polished, pre-drilled & countersunk, to suit Longcase clocks. Manufactured from 1.6mm thick yellow brass.



- Pre - Drilled & Countersunk
- Polished
- Manufactured from 1.6mm Brass
- Width 26.3mm
- Length 37.5mm
- Made in Great Britain

Code	Description	UOM	Price
L34538	Long Case Hood Door Hinge Blanks	PAIR	£7.45

### Hinges, Hood Door Blanks (Non-drilled)

Long Case Clock - Hood Door Hinge Blanks - Non Drilled

Hood door hinge blanks, polished, non drilled, to suit Longcase clocks. Manufactured from 1.6mm thick yellow brass.



- Non Drilled (no holes)
- Polished
- Manufactured from 1.6mm Brass
- Width 26.3mm
- Length 37.5mm
- Made in Great Britain

Code	Description	UOM	Price
L5109	Long Case Clock Hood Hinge Blank	EACH	£1.00

## LOCKS & KEYS

A small range of small locks & keys for clock case doors and other uses in antique repair & restoration.

- Easy Fit
- Brass

### Lock & Key

Lock & Key

- 47 x 30mm Body
- 18mm Thick
- Brass
- Made in E.U



Code	Description	UOM	Price
E5140	Lock & Key	EACH	£9.25

### Lock & Key

Lock & Key

- 46 x 27mm Body
- 17mm Thick
- Brass
- Made in E.U



Code	Description	UOM	Price
E5139	Lock & Key	EACH	£9.95

### Ornamental Key



Lock Ornamental Key

- Brass
- Overall length: 65mm
- Antique Finish
- 10gm
- Made in E.U

Code	Description	UOM	Price
E32043	Lock Ornamental Key	EACH	£2.30

## PILLAR CAPS & COLUMN HOLDERS

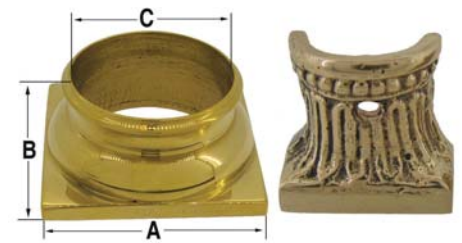

For clock case decoration & embellishment

- Pillar Caps
- Column Holders (Half Pillar Caps)

### Pillar Caps



Clock Case - Pillar Caps

- High quality
- Turned brass
- Polished & lacquered
- UK Made

Dimensions:

- A = Base Width
- B = Overall Height
- C = Internal Pillar Diameter

Code	Description	UOM	Price
E5209	25 x 14 x Ø13mm Pillar Cap	EACH	£15.95
E5210	29 x 14 x Ø19mm Pillar Cap	EACH	£18.95
E5211	32 x 14 x Ø22mm Pillar Cap	EACH	£20.85
E5212	36 x 14 x Ø25mm Pillar Cap	EACH	£21.65
E5213	41 x 19 x Ø29mm Pillar Cap	EACH	£22.95

### Pillar Half Cap, Style 1

Clock Case - Pillar Feet

- Brass
- Antique laquered
- Supplied in Pairs

Dimensions:

- Base Width: 19mm
- Height 18mm



Code	Description	UOM	Price
E32047	Pillar Holder Feet	PAIR	£2.25

### Pillar Half Cap, Style 2

Clock Case - Pillar Feet

- Sold Brass
- Half pillar cap
- Made in E.U

Dimensions:

- Width x height

Code	Description	UOM	Price
P49183	37 x 40mm Pillar Cap	EACH	£21.95
P49184	50 x 45mm Pillar Cap	EACH	£25.95



### Aging Chemicals

See Page: 1156

### Pillar Half Cap, Style 3

Clock Case - Pillar Feet

- Sold Brass
- Half pillar cap
- Made in E.U



Dimensions:  
• Width x height

Code	Description	UOM	Price
P49186	25 x 12mm Pillar Cap	EACH	£5.95

### Pillar Half Cap, Style 4

Clock Case - Pillar Feet

- Sold Brass
- Half pillar cap
- Made in E.U



Dimensions:  
• Width x height

Code	Description	UOM	Price
P49190	30 x 25 Pillar Cap, Orante	EACH	£7.95
P49189	40 x 35 Pillar Cap, Orante	EACH	£9.95

### Pillar Quarter Cap, Quarter Cap Style 1

Clock Case - Pillar Feet

- Sold Brass
- Quarter pillar cap
- Made in E.U



Dimensions:  
• Width x height

Code	Description	UOM	Price
P49185	Quarter Pillar Cap, 10 x 20mm	EACH	£4.95

### Pillar Quarter Cap, Style 2

Clock Case - Pillar Cap

- Sold Brass
- Quarter pillar cap
- Ornate style
- Made in E.U



Dimensions:  
• Width x height

Code	Description	UOM	Price
P49187	30 x 35 Quarter Cap, Orante	EACH	£8.95
P49188	30 x 45 Quarter Cap, Orante	EACH	£11.50



## VIENNA REGULATOR BOTTOMS

Pre-Sanded, Solid Wood Vienna Regulator Clock Base Bottoms

### African Walnut Bottom



Vienna Regulator Bottom - African Walnut

- Top: 195 x 125mm
- Bottom: 60 x 55mm
- Height: 92mm approx
- Wood finish may vary
- Ready to be stained & varnished

Code	Description	UOM	Price
E8777	VR Bottom, African Walnut	EACH	£54.50

### Hardwood (Limba) Bottom



Vienna Regulator Bottom - Hardwood (Limba Wood)

- Top: 166 x 116mm
- Bottom: 74 x 67mm
- Height: 80mm approx
- Pre-sanded, not finished
- Wood finish may vary
- Ready to be stained & varnished

Code	Description	UOM	Price
E8776	VR Bottom, Hardwood	EACH	£49.90

### Oak or Walnut Bottom



Vienna Regulator Bottom - Oak or Walnut

- Top Surface: 152 x 52mm
- Bottom Surface: 65 x 52mm
- Total Height 70mm
- Pre-sanded, not finished, solid wood
- Wood finish may vary
- Ready to be stained & varnished

Code	Description	UOM	Price
E31540	VR Bottom, Oak	EACH	£59.95
E31541	VR Bottom, Walnut	EACH	£59.95

## VIENNA REGULATOR TOPS

### 280 x 125mm Top



Vienna Regulator Top

- Oak or Walnut Veneered
- Wood finish may vary
- Ready to be stained & varnished
- Made in Germany

Dimensions:  
• Width 280mm  
• Height 125mm

Code	Description	UOM	Price
E8773	VR Top, Oak Veneered	EACH	£48.95
E8774	VR Top, Walnut Veneered	EACH	£48.95

### 305 x 180mm Top



Vienna Regulator Top

- Walnut Veneered with Ornaments
- With Turned Finials (Self Assembly)
- Wood finish may vary
- Ready to be stained & varnished
- Made in Germany

Dimensions:  
• Width 305mm  
• Height 180mm

Code	Description	UOM	Price
E8775	VR Top, Walnut Veneered	EACH	£82.95

### 330 x 86mm Top



Vienna Regulator Top

- Solid Oak
- Wood finish may vary
- Ready to be stained & varnished

• Made in Germany

Dimensions:

- Width 330mm
- Height 86mm

Code	Description	UOM	Price
E8772	VR Top, Solid Oak	EACH	£52.50

**350 x 230mm Top**



Vienna Regulator Top

- Walnut Veneered with ornaments
- With Turned Finials (Self Assembly)
- Wood finish may vary
- Ready to be stained & varnished
- Made in Germany

Dimensions:

- Width 350mm
- Height 230mm

Code	Description	UOM	Price
E8771	VR Top, Walnut Veneered	EACH	£75.50

**370 x 268mm Top**



Vienna Regulator Top

- Plywood with unfinished ornaments
- With Turned Finials (Self Assembly)
- Wood finish may vary
- Ready to be stained & varnished
- Made in Germany

Dimensions:

- Width 370mm
- Height 268mm

Code	Description	UOM	Price
E8770	VR Top, Plywood	EACH	£89.90

**Lacquers**

See Page: 1175

CHAINS & CABLES

*Steel & brass plated steel replacement chain for a variety of clock movements.*

**Cables**



Hermle Cables

Dimensions: Cable wire diameter x overall length

- Calibre 241 series = (1)
- Calibre 351.8 series = (1)
- Calibre 461 series = (2)
- Calibre 471 series = (3)
- Calibre 1161 series = (2)
- Calibre 1171 series = (3)

Code	Description	UOM	Price
HERB02601246	Ø1.05mm x 135cm (Hermle 1)	EACH	£15.95
H43129	Ø1.05mm x 230cm (Hermle 2)	EACH	£15.95
HERB02601794	Ø1.05mm x 270cm (Hermle 3)	EACH	£15.95

**Chain, Aluminium (Decorative)**



Clock Chain - Aluminium - For Quartz Clocks

- Decorative chain for quartz clocks
- Brass coloured aluminium
- 2 metres

Dimensions: Wire diameter x total length (links per foot)

Code	Description	UOM	Price
C46059	Ø1.20mm x 200cm (LPF 62)	2 METRES	£1.95
C46060	Ø1.50mm x 200cm (LPF 53)	2 METRES	£2.50
C46061	Ø1.80mm x 200cm (LPF 40)	2 METRES	£2.95

**Chain, Brass**



Clock Chain - Brass or Brass Plated Chain

Brass chains for all types of clocks and mechanisms using gears

- Various wire diameters
- Various lengths
- Made in Germany, China or A\*F Swiss
- German chain supplied with hook and ring
- Solid brass or brass plated

• \* = Solid brass

Hermle Chains

- Calibre 241 series = (1)
- Calibre 261 series = (3)
- Calibre 451 series = (1)
- Calibre 461 series = (1)
- Calibre 471 series = (2)
- Calibre 1151 series = (1)
- Calibre 1161 series = (2)
- Calibre 1171 series = (2)

See additional information for full specification

Dimensions: Wire diameter x total length (links per foot)

Code	Description	UOM	Price
C0376	Ø0.70mm x 180cm (LPF 66), A*F Swiss	PACK*2	£6.50
C0377	Ø0.70mm x 180cm (LPF 72), A*F Swiss	PACK*2	£6.50
C0375	Ø0.90mm x 180cm (LPF 61), German	EACH	£6.50
C45628	Ø1.00mm x 180cm (LPF 50), German	EACH	£6.50
C45629	Ø1.05mm x 180cm (LPF 52), German*	EACH	£7.95
C0373	Ø1.05mm x 200cm (LPF 47), German	EACH	£6.50
C47645	Ø1.20mm x 200cm (LPF 38)	EACH	£3.75
C48934	Ø1.40mm x 150cm (LPF 42)	EACH	£4.95
HERE01701760	Ø1.40mm x 180cm (LPF 47) Hermle (3)	EACH	£9.35
C48935	Ø1.60mm x 150cm (LPF 46)	EACH	£4.95
C47646	Ø1.60mm x 200cm (LPF 37)	EACH	£3.85
HER45555	Ø1.70mm x 150cm (LPF 46) Hermle (2)	EACH	£9.95
HERE01700730	Ø1.70mm x 150cm (LPF 48) Hermle (1)	EACH	£9.95
C47647	Ø2.00mm x 200cm (LPF 25)	EACH	£3.95

Price breaks available, see website

**Chain, Steel**



Clock Chain - Steel Chain

Steel chains for English Longcase clocks

- Various wire diameters
- 365cm (12 feet)
- Made in Germany or UK
- See more info for additional specification

Dimensions:

- Wire diameter x total length (links per foot)

Code	Description	UOM	Price
C34656	Ø1.50mm x 365cm (42 LPF), Made in UK	EACH	£10.15
C32822	Ø1.60mm x 365cm (43½ LPF), Made in Germany	EACH	£19.95
C34654	Ø1.80mm x 365cm (33 LPF), Made in UK	EACH	£9.45
C34655	Ø1.80mm x 365cm (36 LPF), Made in UK	EACH	£9.95

Gorilla Glue

See Page: 1152

# CLICKS & CLICK SPRINGS

Our Clock Clicks & Click Springs are manufactured from high grade spring steel

## C Clip Retaining Springs

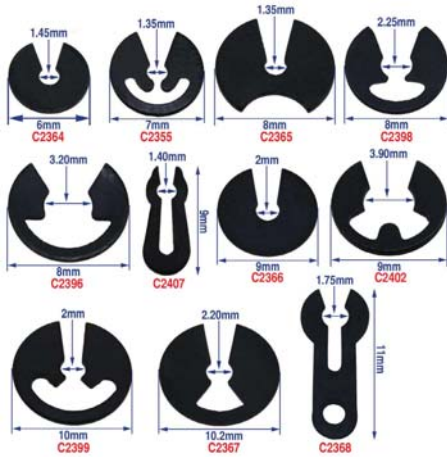

Clock Retaining C Clips

- High grade spring steel
- Various Diameters
- Various Shapes

See website "Image & More Information" for full specification

Code	Description	UOM	Price
C2364	6mm x 1.45mm C-Clip Click Spring	EACH	£3.95
C2355	7mm x 1.35mm C-Clip Click Spring	EACH	£3.95
C2365	8mm x 1.35mm C-Clip Click Spring	EACH	£3.95
C2398	8mm x 2.25mm C-Clip Click Spring	EACH	£3.95
C2396	8mm x 3.20mm C-Clip Click Spring	EACH	£3.95
C2407	9mm x 1.40mm C-Clip Click Spring	EACH	£3.95
C2366	9mm x 2.00mm C-Clip Click Spring	EACH	£3.95
C2402	9mm x 3.90mm C-Clip Click Spring	EACH	£3.95
C2399	10mm x 2.00mm C-Clip Click Spring	EACH	£3.95
C2367	10.2mm x 2.20mm C-Clip Click Spring	EACH	£3.95
C2368	11mm x 1.75mm C-Clip Click Spring	EACH	£3.95

## Click & Spring, Combined



Click & Spring (Combined) - Clock

- Brass
- Steel Rivet
- Click with Brass Tail Spring
- Pack of 6 pieces with rivets

Code	Description	UOM	Price
A4956	Clock Click & Springs Combined	EACH	£2.45



## Clicks & Rivets



Click & Rivets (Separate) - Clock

- Brass
- Brass Rivet
- Click with Brass Rivets
- Pack of 50 pieces with 50 rivets
- Assorted Sizes

Code	Description	UOM	Price
A4955	Clicks And Rivets for Clocks	EACH	£4.95

## Click for Longcase Great Wheel

Long Case Clock - Click for Great Wheel

- Bent and threaded
- Steel
- UK made
- Overall length 30mm
- Overall height 12.5mm
- Thread diameter Ø4.00mm
- Thread length 7mm
- Can be filed & shaped to fit



Code	Description	UOM	Price
L0906	Long Case Great Wheel Click	EACH	£4.10

## Clicks by Size



Clock Clicks - Individual by Size

- High grade steel
- Overall Length in millimetres

Code	Description	UOM	Price
C2406	9mm Clock Click	EACH	£3.95
C2385	10.6mm Clock Click	EACH	£3.95
C2363	14mm Clock Click	EACH	£3.95
C2390	17.5mm Clock Click	EACH	£3.95
C2356	20mm Clock Click with Combined Spring	EACH	£3.95



Hammers - All Kinds

See Page 906

## Click Spring Wire

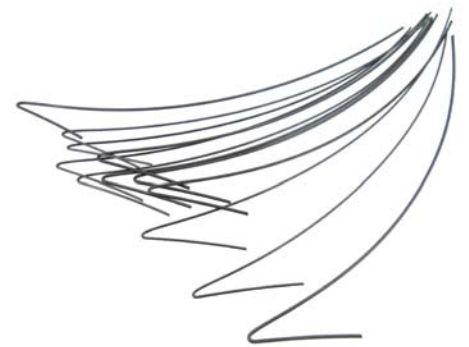

Click Spring Wires - Clocks - Assorted Ø

- Pack of 12 pieces
- Length 110mm approx.
- Various Wire Diameters

Code	Description	UOM	Price
C32033	Wire Clicks for Clocks	PACK*12	£1.50

## Click Springs, Assorted

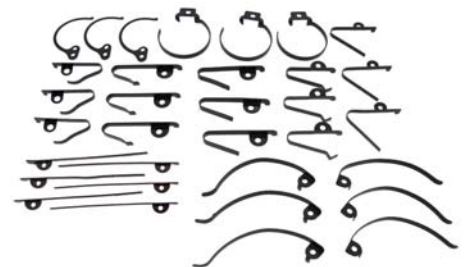

- Assorted clock click springs
- Circular with holes, circular with tabs, straight (left & right), U shape & V shape
- 11 styles
- 3 pieces each
- Pack\*33

Code	Description	UOM	Price
S47504	Assorted Clock Click Springs	PACK*33	£19.95

## Circular (for Longcase Clocks)

Long Case Clock - Circular Steel Click

Composite circular click to suit early 30hr movements. The flat section of the click is manufactured from spring steel. It can easily be drilled, then bent to fit the movement being worked on.



- Dimensions:
- Outside Ø51mm
  - Bore Ø37.8mm

Code	Description	UOM	Price
L34558	Long Case Circular Steel Click	EACH	£22.05



Planishing Blocks

See Page 882



**Circular with Holes, Flat**



**Clock Click Springs - Circular with Holes - Flat**

- High grade spring steel
- Circular clockwise or anti-clockwise when viewed fixed (reversible)
- Screw / fixing holes

See website "Image & More Information" for full specification

Code	Description	UOM	Price
C2354	Ø15mm Clock Click Spring	EACH	£3.95
C2351	Ø17.5mm Clock Click Spring	EACH	£3.95
C2350	Ø19mm Clock Click Spring	EACH	£3.95
C2349	Ø19.7mm Clock Click Spring	EACH	£3.95
C2347	Ø28.5mm Clock Click Spring	EACH	£3.95

**Circular with Tabs**



**Clock Click Springs - Circular with Tabs**

- High grade spring steel
- Circular clockwise or anti-clockwise when viewed fixed

See website "Image & More Information" for full specification

Code	Description	UOM	Price
C2405	Ø14mm Clock Click Spring	EACH	£3.95
C2346	Ø23mm Clock Click Spring, Anti-Clockwise	EACH	£1.50
C2409	Ø39mm Clock Click Spring, Anti-Clockwise	EACH	£3.95
C2408	Ø39mm Clock Click Spring, Clockwise	EACH	£3.95

**Circular with Tabs, Flat**



**Clock Click Springs - Circular with Tabs - Flat**

- High grade spring steel
- Circular clockwise when viewed fixed

See website "Image & More Information" for full specification

Code	Description	UOM	Price
C2394	Ø13mm Clock Click Spring	EACH	£3.95
C2353	Ø16mm Clock Click Spring	EACH	£3.95
C2393	Ø20.5mm Clock Click Spring	EACH	£3.95
C2352	Ø21mm Clock Click Spring, Anti-Clockwise	EACH	£3.95
C2348	Ø21mm Clock Click Spring with Hole	EACH	£3.95
C2392	Ø21mm Clock Click Spring	EACH	£3.95

**Comma Foot (for Longcase Clocks)**



**Long Case Clock - Click Spring - Comma Foot**

Standard click spring with comma foot fixing. Manufactured from hard brass.

- Brass
- Curved
- Overall length: 60mm (approx.)

Code	Description	UOM	Price
L38763	Long Case Comma Foot Click Spring, Indian	EACH	£1.15
L0907	Long Case Comma Foot Click Spring	EACH	£1.50

**Straight by Size**



**Clock Click Springs - Straight**

Right or Left descriptions are for only differentiation between the springs and do not represent a fitting style

- High grade spring steel
- Average overall length 47mm

Code	Description	UOM	Price
C2360	Left Clock Click Spring	EACH	£3.95
C2361	Left with Tab Clock Click Spring	EACH	£3.95

C2357	Right Clock Click Spring	EACH	£3.95
C2362	Right with Tab Clock Click Spring	EACH	£3.95

**Straight, Bi-Pin (for Longcase Clocks)**



**Long Case Clock - Click Spring - Bi Pin**

Click Spring manufactured from hard brass with bi-pin fixing.

- Flat
- Brass
- 2 Pin Fixing
- Overall length: 70mm (approx.)
- Length of pin fixings: 10mm (approx.)

Code	Description	UOM	Price
L38760	Long Case Bi-Pin Click Spring, Indian	EACH	£1.15
L4812	Long Case Bi-Pin Click Spring	EACH	£1.55

Price breaks available, see website

**Straight, Pre-Hardened**



**Clock Click Springs - Straight - Pre-Hardened**

These click springs can be bent into any shape required and then hardened and tempered

- Pack of 6 (3 left & 3 right)
- With screw fixing hole & tab

Code	Description	UOM	Price
C2359	Straight, Pre-Hardened Click Springs	PACK*6	£2.95

**U Shape by Size**



**Clock Click Springs - U Shape**

- High grade spring steel
- Circular clockwise or anti-clockwise when viewed fixed
- Second measurement in brackets = outer fixing tabs distance



## COIL/SPIRAL SPRINGS & HAIRSPRINGS (CLOCK)

See website "Image & More Information" for full specification

Code	Description	UOM	Price
C2369	11.4mm (6.35mm) Click Spring	EACH	£3.95
C2375	15mm (6.35mm) Click Spring	EACH	£3.95
C2376	16.8mm (13.6mm) Click Spring	EACH	£3.95
C2401	17.5mm (11.5mm) Click Spring	EACH	£3.95
C2377	18mm (14mm) Click Spring	EACH	£3.95
C2400	19mm (3.6mm) Click Spring	EACH	£3.95
C2372	19mm (4.7mm) Click Spring	EACH	£3.95
C2374	19mm (6mm) Click Spring - Clockwise	EACH	£3.95
C2397	19mm (6mm) Click Spring - Anti-Clockwise	EACH	£3.95
C2379	19mm (11.4mm) Click Spring	EACH	£3.95

### U Shape by Size , Large



Clock Click Springs - U Shape - Larger

- High grade spring steel
- Circular clockwise or anti-clockwise when viewed fixed
- Second measurement in brackets = outer fixing tabs distance

See website "Image & More Information" for full specification

Code	Description	UOM	Price
C2403	20mm (9mm) Click Spring	EACH	£3.95
C2370	20mm (12.5mm) Click Spring	EACH	£3.95
C2371	21.5mm (3.6mm) Click Spring	EACH	£3.95
C2373	21.5mm (15.8mm) Click Spring	EACH	£3.95
C2380	25mm (15.5mm) Click Spring	EACH	£3.95
C2378	25.5mm (6mm) Click Spring	EACH	£3.95
C2381	28mm (17.4mm) Click Spring	EACH	£3.95

### V Shape by Size

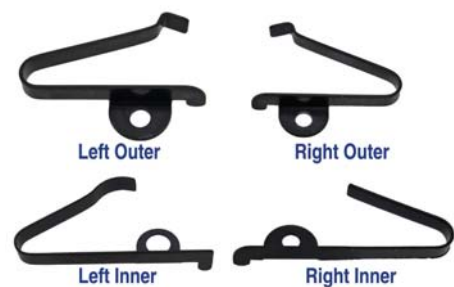

Clock Click Springs - V Shape

Right or left descriptions are for only differentiation between the springs and do not represent a fitting style

- High grade spring steel
- Lengths are approximate

See website "Image & More Information" for full specification

Code	Description	UOM	Price
C2391	19mm Right, Outer Fixing	EACH	£3.50
C2358	19mm Left, Outer Fixing	EACH	£3.50
C13720	23mm Left, Inner Fixing with Tab	EACH	£3.50
C2384	23mm Left, Outer Fixing with Tab	EACH	£3.50
C2383	23mm Right, Outer Fixing with Tab	EACH	£3.50
C2382	24mm Right, Outer Fixing with Tab	EACH	£3.50
C46233	25mm Right, Inner Fixing with Tab	EACH	£3.50
C2387	25mm Left, Outer Fixing with Tab	EACH	£3.50
C2386	25mm Right, Outer Fixing with Tab	EACH	£3.50
C13722	30mm Right, Inner Fixing with Tab	EACH	£3.50
C13721	31.5mm Right, Inner Fixing with Tab	EACH	£3.50

## COIL/SPIRAL SPRINGS & HAIRSPRINGS (CLOCK)

### Hairsprings, Clock

#### Clock Hairspring Assortment



Hair Springs with Collets for Clocks and Alarm Clocks.

- 72 pieces assorted
- Weight 100gms

Code	Description	UOM	Price
H31273	Clock Hairspring Assortment	PACK*72	£9.50

### Spiral Coil Springs

#### Spiral Springs Assortment, Indian

- Useful for Clocks, Toys etc.
- Pack of 10 pieces
- Made in India



Code	Description	UOM	Price
A31332	Spiral Springs Assortment, Indian	PACK*10	£1.95

#### Spiral Springs Assortment, Made in Germany

- Mixture of strong and weak springs
- Specially suited to strike and chime mechanisms
- 100 Pieces
- Made in Germany



Code	Description	UOM	Price
S7788	Spiral Springs Assortment, Made in Germany	PACK*100	£29.95

## CUCKOO PARTS



- Activating Wires, Assorted
- Bellows, Rear Opening
- Bellows, Side Opening
- Birds with Wings
- Dial & Hands Set
- Numerals for Dials
- Pendulum Leaders
- Top Crown, Bird
- Top Crown, Riffles

### Activating Wires, Assorted

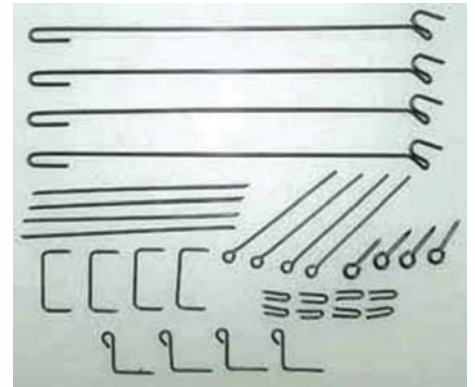

Cuckoo Clock - Activating Wires - Assorted

Very useful set of various activating wires including bellow lifters, connectors, hooks, rods, angles, locking wires & more.

- Cuckoo clock wires
- Steel
- 30 pieces

Code	Description	UOM	Price
W7853	Cuckoo Clock Activating Wires, Assorted	PACK*30	£5.25

### Antlers, Plastic



Deer Antlers - Cuckoo Clock

- Deer Antlers
- Plastic
- Supplied in pairs
- Size given is from holding post to tip of antler
- Original Black Forest cuckoo clock parts
- Made in Germany

Dimensions are approx.

Code	Description	UOM	Price
A43182	60mm Plastic Antlers	PAIR	£1.95
A43183	80mm Plastic Antlers	PAIR	£2.75
A43184	100mm Plastic Antlers	PAIR	£2.95
A43185	110mm Plastic Antlers	PAIR	£3.95

### Antlers, Wooden



Deer Antlers - Cuckoo Clock

- Deer Antlers
- Wooden
- Hand Carved
- Supplied in pairs
- Size given is from holding post to tip of antler
- Original Black Forest cuckoo clock parts
- Made in Germany

Dimensions are approx.

Code	Description	UOM	Price
A43179	Brown, 65mm Wooden Antlers	PAIR	£7.50
A43180	Brown, 80mm Wooden Antlers	PAIR	£7.95
A43181	Brown, 120mm Wooden Antlers	PAIR	£14.50
A43176	Unfinished, 65mm Wooden Antlers	PAIR	£6.95
A43177	Unfinished, 80mm Wooden Antlers	PAIR	£7.25
A43178	Unfinished, 120mm Wooden Antlers	PAIR	£13.95

### Bellows (Quail)

Cuckoo Clock - Bellows - Rear Opening (R/O) - Quail



- Quail Bellow
- Rear opening (R/O)
- Supplied individually
- 5cm
- Standing

Dimensions:

- Pipe height\* (Bellow top length x width)

\*Measured from bottom of pipe to where it joins underside of top bellow top

Code	Description	UOM	Price
B43266	5cm (45 x 30mm) Quail Bellow	EACH	£6.95

### Bellows, Rear Opening



Cuckoo Clock - Bellows - Rear Opening (R/O)

- Rear opening
- Supplied in pairs
- 6.5cm to 16cm
- Standing pair or horizontal and standing pair

Dimensions:

- Pipe height\* (Bellow top length x width)

\*Measured from bottom of pipe to where it joins underside of top bellow top

Code	Description	UOM	Price
B9519	6.5cm (37 x 29mm) Bellows	PAIR	£6.95

B9542	7cm (44 x 29mm) Bellows	PAIR	£7.25
B9543	8cm (44 x 33mm) Bellows	PAIR	£7.75
B43026	8cm (44 x 33mm) Bellows, Horizontal & Standing	EACH	£7.95
B9544	10cm (50 x 33mm) Bellows	PAIR	£7.95
B43028	10cm (50 x 33mm) Bellows, Horizontal & Standing	EACH	£8.25
B9545	12cm (56 x 33mm) Bellows	PAIR	£8.25
B9546	14cm (60 x 40mm) Bellows	PAIR	£13.95
B9547	15cm (60 x 40mm) Bellows	PAIR	£14.25
B9548	16cm (60 x 40mm) Bellows	PAIR	£15.95

### Bellows, Side Opening



Cuckoo Clock - Bellows - Side Opening (S/O)

- Side opening (S/O)
- Supplied in pairs
- 6.5cm to 16cm
- Standing pair or horizontal and standing pair

Dimensions:

- Pipe height\* (Bellow top length x width)

\*Measured from bottom of pipe to where it joins underside of top bellow top

Code	Description	UOM	Price
B0056	6.5cm (37 x 29mm) Bellows	PAIR	£6.95
B0057	7cm (44 x 29mm) Bellows	PAIR	£7.50
B0058	8cm (44 x 33mm) Bellows	PAIR	£7.50
B43025	8cm (44 x 33mm) Bellows, Horizontal & Standing	EACH	£7.95
B0059	10cm (50 x 33mm) Bellows	PAIR	£7.95
B43027	10cm (50 x 33mm) Bellows, Horizontal & Standing	EACH	£9.50
B0060	12cm (56 x 33mm) Bellows	PAIR	£8.25
B43029	12cm (56 x 33mm) Bellows, Horizontal & Standing	EACH	£8.50
B0061	14cm (60 x 40mm) Bellows	PAIR	£13.95
B0062	15cm (60 x 40mm) Bellows	PAIR	£14.25
B0063	16cm (60 x 40mm) Bellows	PAIR	£15.95

### Bellows Leather



- Bellows Leather
- 20cm square of leather (shape may be irregular)
- Designed to be cut to your requirement
- Leather bellows material for recovering bellows tops
- Natural material so the thickness varies
- Original Black Forest cuckoo clock parts
- Made in Germany

Code	Description	UOM	Price
B48989	Bellows Leather	EACH	£14.95

PRICE PROMISE GUARANTEE

### Bellows Paper

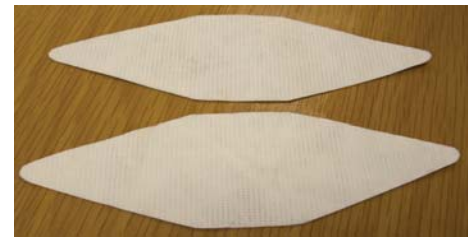

- Bellows paper
- Pre-cut forms
- Tyvek, non tear paper
- Size given is the size of bellow the form is for
- For bellows repair
- Original Black Forest cuckoo clock parts
- Made in Germany

Code	Description	UOM	Price
B43260	For 6.5cm Bellow, Pre Cut Form	PAIR	£0.50
B43261	For 7cm Bellow, Pre Cut Form	PAIR	£0.55
B43262	For 8cm Bellow, Pre Cut Form	PAIR	£0.65
B43263	For 10cm Bellow, Pre Cut Form	PAIR	£0.80
B43264	For 12cm Bellow, Pre Cut Form	PAIR	£0.80
B43265	For 14, 15 & 16cm Bellow, Pre Cut Form	PAIR	£0.90

### Bellows Stickers

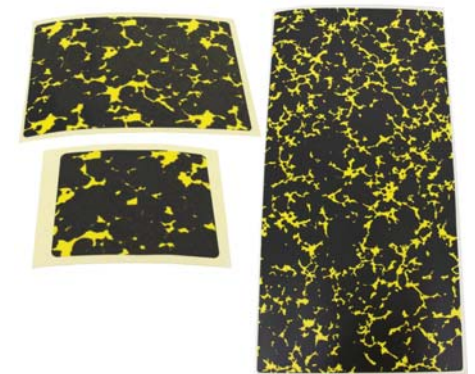

- Marble yellow and black paper stickers
- For bellows repair
- Can be cut to required size
- Original Black Forest cuckoo clock parts
- Made in Germany

Top = Label for the top of the bellow

Side = Label for the side of the bellow (can be cut to required width)

Dimensions:

- Length x width

Code	Description	UOM	Price
B43281	26 x 30mm Bellows Sticker (Top)	EACH	£0.25
B43282	27 x 37mm Bellows Sticker (Top)	EACH	£0.25
B43284	37 x 53mm Bellows Sticker (Top)	EACH	£0.48
B43285	135 x 70mm Bellows Sticker (Side)	EACH	£0.80
B43286	145 x 70mm Bellows Sticker (Side)	EACH	£1.15
B43287	155 x 70mm Bellows Sticker (Side)	EACH	£1.45



Online Discounts

Clock Pivot Locating Tools

See Page 776



**Bellows Tops**



Bellows Tops - Cuckoo Clock

- Bellows Tops
- 1 or 8 day (8 day bellow tops have a heavier weight insert)
- Supplied in pairs
- Great for replacement and repair
- Original Black Forest cuckoo clock parts
- Made in Germany

Code	Description	UOM	Price
B43014	37 x 29mm Bellow Tops, 1 Day	PAIR	£5.50
B43019	37 x 56mm Bellow Tops, 1 Day	PAIR	£5.50
B43015	44 x 29mm Bellow Tops, 1 Day	PAIR	£5.50
B43016	44 x 33mm Bellow Tops, 1 Day	PAIR	£5.50
B43021	44 x 33mm Bellow Tops, 8 Day	PAIR	£5.50
B43017	50 x 33mm Bellow Tops, 1 Day	PAIR	£5.50
B43022	50 x 33mm Bellow Tops, 8 Day	PAIR	£5.50
B43018	56 x 33mm Bellow Tops, 1 Day	PAIR	£5.50
B43023	56 x 33mm Bellow Tops, 8 Day	PAIR	£5.50
B43020	60 x 40mm Bellow Tops, 1 Day	PAIR	£5.50
B43024	60 x 40mm Bellow Tops, 8 Day	PAIR	£5.50

**Birds**

Cuckoo Clock Birds

- Various styles and colours
- Plastic or wooden
- Painted or unfinished
- Metal mount with clamp screw
- Fixed or moveable wings
- Original Black Forest cuckoo clock parts
- Made in Germany
- See additional website information for full specification
- Birds are hand painted so finishes may vary

**Plastic Cuckoo Bird, Fixed Wings**



- Approx 78mm Long
- Plastic Body with Painted Wings
- Metal Foot with Clamp Screw
- Fixed Wings

Code	Description	UOM	Price
E33018	Plastic Cuckoo Bird, Fixed Wings	EACH	£2.95

**Plastic Cuckoo Bird, Moveable Wings**



- Approx 78mm Long
- Plastic Body with Painted Wings
- Metal Foot with Clamp Screw
- Moveable Wings

Code	Description	UOM	Price
E33019	Plastic Cuckoo Bird, Moveable Wings	EACH	£14.95

**Wooden Cuckoo Bird, Blue**



- Approx 100mm Long
- Wooden
- Metal mount with clamp screw
- Fixed wings
- Blue with yellow, black and red

Code	Description	UOM	Price
B43145	Wooden Cuckoo Bird, Blue	EACH	£7.95

**Wooden Cuckoo Bird, Grey**



- Approx 100mm Long
- Wooden
- Metal mount with clamp screw
- Fixed wings
- Grey with yellow, red, black and white

Code	Description	UOM	Price
B43144	Wooden Cuckoo Bird, Grey	EACH	£18.75

**Wooden Cuckoo Bird, Unfinished**



- Approx 90mm Long
- Wooden
- Metal mount with clamp screw
- Unfinished with red beak

Code	Description	UOM	Price
B43143	Wooden Cuckoo Bird, Unfinished	EACH	£9.95



WD-40 Lubricating Aerosols

See Page 1180

**Cuckoo Sound Demonstration Device**



Cuckoo Sound Demonstration Device

- Use the handle to turn the tree to emit the unmistakable cuckoo noise
- Excellent for advertising, promotion & demonstrations
- Tool to show your customers the classic cuckoo bellows noise
- Ideal for retail counter tops
- 140mm bellows
- Original Black Forest cuckoo clock parts
- Made in Germany

Dimensions:

- 150 x 130 x 75mm (height x width x depth)

Code	Description	UOM	Price
C44353	Cuckoo Sound Demonstration Device	EACH	£16.50

**Dancing Couple**



Cuckoo Clock Dancing Couple

- Wooden
- Male and female
- Male 35mm tall
- Female 32mm tall
- Unfinished
- Original Black Forest cuckoo clock parts
- Made in Germany

Code	Description	UOM	Price
D43259	Dancing Couple for Cuckoo Clock	EACH	£2.95



**Deer Heads**

Deer Heads - Cuckoo Clock

- Deer heads
- Hand carved (Look may vary)
- Unfinished
- With antler holes (plastic antlers A43182, wooden antlers A43179)
- With glass eyes (except for D43200)
- Original Black Forest cuckoo clock parts
- Made in Germany



Dimensions:

- Overall height x ear to ear

Dimensions are approx.

Code	Description	UOM	Price
D43195	65 x 60mm Deer Head	EACH	£9.95
D43197	75 x 65mm Deer Head	EACH	£12.75
D43198	90 x 70mm Deer Head	EACH	£13.95
D43199	105 x 90mm Deer Head	EACH	£15.95
D43200	115 x 110mm Deer Head	EACH	£23.50

**Dials**



Cuckoo Clock Dials

- Turned and stained wood
- White numerals
- Ø100mm dials and under numerals are painted on, over Ø100mm have plastic numerals
- Various diameters
- Original Black Forest cuckoo clock parts
- Made in Germany

Dimensions: Diameter x Thickness

Dimensions are approx.

Code	Description	UOM	Price
D43161	Ø60mm (4mm) Wooden Dial	EACH	£3.25
D43162	Ø70mm (4.5mm) Wooden Dial	EACH	£3.75
D43163	Ø80mm (4.5mm) Wooden Dial	EACH	£3.95
D43164	Ø90mm (4.5mm) Wooden Dial	EACH	£4.15
D43165	Ø100mm (4.5mm) Wooden Dial	EACH	£4.50
D43166	Ø120mm (5mm) Wooden Dial	EACH	£6.25
D43167	Ø130mm (5mm) Wooden Dial	EACH	£7.30

**Dial & Hands Set**



Cuckoo Clock Dials with Hands

- Turned and stained wood
- Applied numerals
- Complete with matching pair of hands
- Various Diameters
- Made in Germany

Dimensions: Diameter x Thickness

Code	Description	UOM	Price
D7747	Ø60mm (3.5mm) Cuckoo Dial	EACH	£9.50
D7748	Ø80mm (4mm) Cuckoo Dial	EACH	£9.95
D7749	Ø90mm (4mm) Cuckoo Dial	EACH	£10.95
D37750	Ø110mm (4mm) Cuckoo Dial	EACH	£15.95

**Doors**



Cuckoo Clock Doors

- Brown, green or unfinished
- Wooden
- Can be adjusted to suit
- Original Black Forest cuckoo clock parts
- Made in Germany

Dimensions (approx.)

- Width x height

Code	Description	UOM	Price
D43134	Brown 20 x 22mm Door	EACH	£0.50
D43137	Brown, 25 x 32mm Door	EACH	£0.75
D43140	Brown, 30 x 40mm Door	EACH	£0.75
D43135	Green, 20 x 22mm Door	EACH	£0.85
D43138	Green, 25 x 32mm Door	EACH	£0.95
D43141	Green, 30 x 40mm Door	EACH	£1.25
D43133	Unfinished, 20 x 22mm Door	EACH	£0.75
D43136	Unfinished, 25 x 32mm Door	EACH	£0.50
D43139	Unfinished, 30 x 40mm Door	EACH	£0.75

**Doors (Back) with Gong**



Cuckoo Clock Back Door with Gong

- Cuckoo clock back door
- With appropriate size gong attached
- Brown, walnut stained finished
- Original Black Forest cuckoo clock parts
- Made in Germany

Dimensions (approx.)

- Width x height

Code	Description	UOM	Price
G43255	105 x 110mm Back Door and Gong	EACH	£9.95
G43256	120 x 130mm Back Door and Gong	EACH	£11.95
G43257	135 x 140mm Back Door and Gong	EACH	£13.95
G43258	155 x 160mm Back Door and Gong	EACH	£14.95

**Eyes (Deer & Bird)**



Deer & Bird Eyes - Cuckoo Clock

- Deer & bird eyes
- Glass
- Supplied in pairs
- Original Black Forest cuckoo clock parts
- Made in Germany

Code	Description	UOM	Price
E43186	Ø2mm Deer Eye	PAIR	£0.95
E43187	Ø3mm Deer Eye	PAIR	£0.95
E43188	Ø4mm Deer Eye	PAIR	£0.95
E43189	Ø5mm Deer Eye	PAIR	£0.95
E43190	Ø6mm Deer Eye	PAIR	£0.95
E43192	Ø8mm Deer Eye	PAIR	£0.95
E43194	Ø10mm Deer Eye	PAIR	£1.20

Gongs - Spiral for Cuckoo Clocks

See Page 1257



**Cuckoo Clock Movements**

See Page: 1316



**Cuckoo Clock Movements**

See Page: 1318

**Horn & Mouthpiece Sets**



Horn & Mouthpiece Sets - Cuckoo Clock

- Clock horn & mouthpiece
- Hand carved
- Brown or unfinished
- Original Black Forest cuckoo clock parts
- Made in Germany

Dimensions:

- Horn diameter x height

Dimensions are approx.

Code	Description	UOM	Price
C43172	Brown, Ø28 x 30mm Horn with Mouthpiece	EACH	£4.15
C43173	Brown, Ø35 x 33mm Horn with Mouthpiece	EACH	£4.30
C43174	Brown, Ø42 x 37mm Horn with Mouthpiece	EACH	£5.50
C43175	Brown, Ø55 x 55mm Horn with Mouthpiece	EACH	£5.85
C43168	Unfinished, Ø28 x 30mm Horn with Mouthpiece	EACH	£3.50
C43169	Unfinished, Ø35 x 33mm Horn with Mouthpiece	EACH	£3.75
C43170	Unfinished, Ø42 x 37mm Horn with Mouthpiece	EACH	£4.15
C43171	Unfinished, Ø55 x 37mm Horn with Mouthpiece	EACH	£5.15

**Numerals for Dials (Plastic)**



Cuckoo Clock Numerals - Plastic

- Sets of numerals
- 1 set contains; 20 batons, 4 x "X" and 4 x "V"
- Heights: 9, 11, 12, 14, 16, 20, 23 & 28mm
- Made of white plastic
- Size given is numeral height
- Cement or pin in place
- Original Black Forest cuckoo clock parts
- Made in Germany

Code	Description	UOM	Price
N43147	9mm Roman Cuckoo Numerals	EACH	£0.95
N43148	11mm Roman Cuckoo Numerals	EACH	£0.95
N43149	12mm Roman Cuckoo Numerals	EACH	£0.95
N43150	14mm Roman Cuckoo Numerals	EACH	£1.10
N43151	16mm Roman Cuckoo Numerals	EACH	£1.25
N43152	20mm Roman Cuckoo Numerals	EACH	£1.65
N43153	23mm Roman Cuckoo Numerals	EACH	£1.80
N44279	28mm Roman Cuckoo Numerals	EACH	£2.95



**Numerals for Dials (Wooden)**

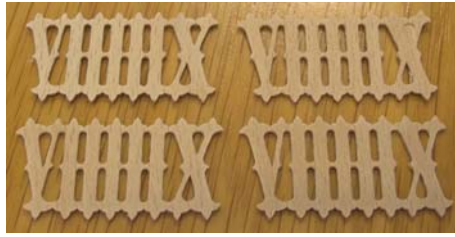

Cuckoo Clock Numerals - Wooden

- Sets of numerals
- 1 set contains; 20 batons, 4 x "X" and 4 x "V"
- Heights: 9, 11, 12, 14, 16, 20, 23 & 28mm
- Wooden
- Size given is numeral height
- Can be used as they are or finished to desired style
- Cement or pin in place
- Original Black Forest cuckoo clock parts
- Made in Germany

Code	Description	UOM	Price
N43154	9mm Roman Cuckoo Numerals	EACH	£1.25
N43155	11mm Roman Cuckoo Numerals	EACH	£1.25
N43156	12mm Roman Cuckoo Numerals	EACH	£1.25
N43157	14mm Roman Cuckoo Numerals	EACH	£1.25
N43158	16mm Roman Cuckoo Numerals	EACH	£1.50
N43159	20mm Roman Cuckoo Numerals	EACH	£2.25
N43160	24mm Roman Cuckoo Numerals	EACH	£2.50
N44280	28mm Roman Cuckoo Numerals	EACH	£3.55

**Pendulum Leaders**

Cuckoo Clock & Black Forest Pendulum Leaders

- Total length 80, 90, 100 & 110mm
- 2 pieces of each
- Pack of 8
- Made in Germany

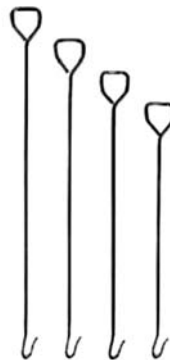

Code	Description	UOM	Price
L7746	Cuckoo Pendulum Leaders	PACK*8	£5.50

# Adhesives, Cements & Tapes

**See Page: 1149**

**Top Crown, Bird**



Cuckoo Clock - Top Crown - Head Pieces

- Bird & Maple Leaves
- Hand carved
- Brown, blonde, green or unfinished
- Original Black Forest cuckoo clock parts
- Made in Germany

Dimensions:

- Colour, width x height

Code	Description	UOM	Price
T43236	Brown, 21 x 11.5cm	EACH	£9.95
T43237	Brown, 24 x 16cm	EACH	£16.95
T43238	Brown, 30 x 19cm	EACH	£25.95
T43239	Brown, 35 x 21cm	EACH	£35.65
T43245	Blonde, 17.5 x 10cm	EACH	£15.95
T43246	Blonde, 21 x 11.5cm	EACH	£16.95
T43247	Blonde, 24 x 16cm	EACH	£19.95
T43248	Blonde, 30 x 19cm	EACH	£27.95
T43249	Blonde, 35 x 21cm	EACH	£36.95
T43244	Green (Pale), 35 x 21cm	EACH	£39.95
T48049	Green, 17.5 x 10cm	EACH	£24.95
T48069	Green, 21.5 x 11.5cm	EACH	£29.95
T48050	Green, 24 x 16cm	EACH	£32.95
T48070	Green, 30 x 19cm	EACH	£49.95
T48071	Green, 35 x 21cm	EACH	£53.65
T43230	Unfinished, 17.5 x 10cm	EACH	£8.95
T43231	Unfinished, 21 x 11.5cm	EACH	£8.95
T43232	Unfinished, 24 x 16cm	EACH	£12.95
T43233	Unfinished, 30 x 19cm	EACH	£17.95
T43234	Unfinished, 35 x 21cm	EACH	£26.95

**Top Crown, Rifles**



Cuckoo Clock - Top Crown - Head Pieces

- Oak leaves & Crossed Rifles
- Hand carved
- Pre-sanded wood
- Ready to be varnished or stained
- Dimensions are for overall width (approx)

Code	Description	UOM	Price
E7875	220mm Cuckoo Crown	EACH	£12.20
E7876	310mm Cuckoo Crown	EACH	£24.50

**Top Crown, Stags Head**



Cuckoo Clock - Top Crown - Head Pieces

- Stag head and rifles
- Supplied with antlers
- Hand carved
- Brown
- Original Black Forest cuckoo clock parts
- Made in Germany

Dimensions:  
• Colour, width x height

Code	Description	UOM	Price
T43250	Brown, 18 x 11.5cm	EACH	£34.95
T43251	Brown, 22 x 12.5cm	EACH	£35.95
T43252	Brown, 24.5 x 14.5cm	EACH	£37.50
T43253	Brown, 31 x 17cm	EACH	£39.95
T43254	Brown, 36.5 x 21cm	EACH	£43.95

**Top Crown Fixings**



Cuckoo Clock - Top Crown Fixings

- Fixes the top crown to the case
- Steel
- Pack\*2

Code	Description	UOM	Price
C45735	Top Crown Fixings	PACK*2	£2.50



**Water Wheel**

Cuckoo Clock Water Wheel

- Wooden
- Ø60mm
- Unfinished
- Original Black Forest cuckoo clock parts
- Made in Germany



Code	Description	UOM	Price
W43142	Water Wheel for Cuckoo Clock	EACH	£4.50

**DIALS & CHAPTER RINGS & MOON DISCS**

**CHAPTER RINGS, Ø48MM (SMALL SECONDS)**

**Seconds (Gold), Arabic**

Chapter Rings - Long Case - Small Seconds

- Arabic Black Figures
- Brass Background
- Satin finish with etched black design
- Flat Profile
- Metal



Dimensions in millimetres:  
Outside Ø x (outer zone Ø) x Inside Ø

Code	Description	UOM	Price
D7774	48mm (44mm) x 28mm Ring	EACH	£7.90

**Seconds (Silver), Arabic**

Chapter Rings - Long Case - Small Seconds

- Arabic Black Figures
- Silver Background
- Satin finish with etched black design
- Flat Profile
- Metal



Dimensions in millimetres:  
Outside Ø x (outer zone Ø) x Inside Ø

Code	Description	UOM	Price
D7773	48mm (44mm) x 28mm Ring	EACH	£6.80

**Brads (Fixing Pins)**



Ref: P8971 See Page: 1248

**CHAPTER RINGS, Ø51MM (2")**

Dimensions:  
Numerals, Outside Ø in millimetres (inches)  
Style, Colour, Zone Ring Outer Edge Ø in millimetres (inches)

If you require a chapter that is different in colour or style please submit an online support request under "products & stock - I can't find what I am looking for - I am looking for something else". Please specify the size required, numeral type and ring colour

**Roman Ø70mm (2¾") Flat, Silver, Ø68mm (2¾")**

Chapter Rings - Flat Profile - with Diamond Cut Bevelled Edge

- Roman Black Figures
- Silver Background
- 0.60mm thick diamond cut bevelled edge
- Outer Minute Zone
- Flat Profile
- Aluminium
- Made in Germany



Dimensions:  
• Outside Ø x (outer zone Ø) x Inside Ø

Code	Description	UOM	Price
D12407	Ø72mm (Ø68mm) x Ø40mm Ring	EACH	£6.95

**CHAPTER RINGS, Ø76MM (3")**

Dimensions:  
Numerals, Outside Ø in millimetres (inches)  
Style, Colour, Zone Ring Outer Edge Ø in millimetres (inches)

If you require a chapter that is different in colour or style please submit an online support request under "products & stock - I can't find what I am looking for - I am looking for something else". Please specify the size required, numeral type and ring colour

**Roman Ø76mm (3") Flat, Gold, Ø89mm (2¾") Diamond Cut**

Outside diameter: Ø76mm (3")  
Zone ring outer diameter: Ø70mm (2¾")

- Roman Black Figures
- with Diamond Cut Bevelled Edge
- 0.60mm Thick
- Brass Background
- Flat Profile
- Aluminium



Dimensions:  
• Outside Ø x (outer zone Ø) x Inside Ø

Code	Description	UOM	Price
D12404	Ø76mm (Ø70mm) x Ø40mm Ring	EACH	£6.95

**Roman Ø76mm (3") Flat, Silver, Ø70mm (2¾")**

Outside diameter: Ø76mm (3")  
Zone ring outer diameter: Ø70mm (2¾")

- Roman Black Figures
- Silver Background
- Outer Minute Zone
- Flat Profile
- Aluminium
- Made in UK

Dimensions:  
• Outside Ø x (outer zone Ø) x Inside Ø



Code	Description	UOM	Price
D12460	Ø76mm (Ø70mm) x Ø45mm Ring	EACH	£4.70

**Roman Ø95mm (3¾") Flat, Gold, Ø89mm (3½") Diamond Cut**

Outside diameter: Ø95mm (3¾")  
Zone ring outer diameter: Ø89mm (3½")

- Roman Black Figures
- with Diamond Cut Bevelled Edge
- 0.60mm Thick
- Brass Background
- Flat Profile
- Aluminium

Dimensions:  
• Outside Ø x (outer zone Ø) x Inside Ø



Code	Description	UOM	Price
D12405	Ø95mm (Ø89mm) x Ø57mm Ring	EACH	£7.25

**Roman Ø95mm (3¾") Flat, Silver, Ø89mm (3½") Diamond Cut**

Outside diameter: Ø95mm (3¾")  
Zone ring outer diameter: Ø89mm (3½")

- Roman Black Figures
- Silver Background
- 0.60mm thick diamond cut bevelled edge
- Outer Minute Zone
- Flat Profile
- Aluminium
- Made in Germany

Dimensions:  
• Outside Ø x (outer zone Ø) x Inside Ø



Code	Description	UOM	Price
D12408	Ø95mm (Ø89mm) x Ø57mm Ring	EACH	£7.50

**Roman Ø95mm (3¾") Flat, White, Ø89mm (3½") with Gold Rim**

Outside diameter: Ø95mm (3¾")  
Zone ring outer diameter: Ø89mm (3½")

- Roman Black Figures
- White Background with Brass Rim
- 0.60mm Thick with Bevel Edge
- Flat Profile
- Aluminium

Dimensions:  
• Outside Ø x (outer zone Ø) x Inside Ø



Code	Description	UOM	Price
D12411	Ø95mm (Ø89mm) x Ø57mm Ring	EACH	£8.50

**CHAPTER RINGS, Ø102MM (4")**

Dimensions:  
Numerals, Outside Ø in millimetres (inches)  
Style, Colour, Zone Ring Outer Edge Ø in millimetres (inches)

If you require a chapter that is different in colour or style please submit an online support request under "products & stock – I can't find what I am looking for – I am looking for something else". Please specify the size required, numeral type and ring colour

**Roman Ø102mm (4") Flat, Silver, Ø96mm (3¾")**

Outside diameter: Ø102mm (4")  
Zone ring outer diameter: Ø96mm (3¾")

- Roman Black Figures
- Silver Background
- Outer Minute Zone
- Flat Profile
- Aluminium
- Made in UK

Dimensions:  
• Outside Ø x (outer zone Ø) x Inside Ø



Code	Description	UOM	Price
D12461	Ø102mm (Ø96mm) x Ø63mm Ring	EACH	£5.70

**Roman Ø102mm (4") Flat, White, Ø96mm (3¾")**

Outside diameter: Ø102mm (4")  
Zone ring outer diameter: Ø96mm (3¾")

- Roman Black Figures
- White Background
- Outer Minute Zone
- 0.50mm Thick
- Flat Profile
- Aluminium

Dimensions:  
• Outside Ø x (outer zone Ø) x Inside Ø



Code	Description	UOM	Price
D12447	Ø102mm (Ø96mm) x Ø63mm Ring	EACH	£4.95

**Roman Ø115mm (4½") Flat, White, Ø109mm (3¾")**

Outside diameter: Ø115mm (4½")  
Zone ring outer diameter: Ø109mm (3¾")

- Roman Black Figures
- Off White Background
- Outer & Inner Minute Zone
- Flat Profile
- Aluminium
- Made in Germany

Dimensions:  
• Outside Ø x (outer zone Ø) x Inside Ø



Code	Description	UOM	Price
D12397	Ø115mm (Ø109mm) x Ø72mm Ring	EACH	£32.65

**CHAPTER RINGS, Ø127MM (5")**

Dimensions:  
Numerals, Outside Ø in millimetres (inches)  
Style, Colour, Zone Ring Outer Edge Ø in millimetres (inches)

If you require a chapter that is different in colour or style please submit an online support request under "products & stock – I can't find what I am looking for – I am looking for something else". Please specify the size required, numeral type and ring colour

**Arabic Ø127mm (5") Flat, Silver, Ø110mm (4¼") With Glass & Bezel**

Outside diameter: Ø127mm (5")  
Zone ring outer diameter: Ø110mm (4¼")

- Roman Black Figures
- Silver Background
- Outer Minute Zone
- Flat Profile
- Aluminium
- Brass Embossed Bezel, Hinged
- Convex Glass
- Overall diameter Ø130mm

Dimensions:  
• Outside Ø x (outer zone Ø) x Inside Ø



Code	Description	UOM	Price
D5263	Ø127mm (Ø110mm) x Ø73mm Ring with Bezel & Glass	EACH	£21.60

**Roman Ø127mm (5") Flat, Gold, Ø121mm (4¾")**

Outside diameter: Ø127mm (5")  
Zone ring outer diameter: Ø121mm (4¾")

- Roman Black Figures
- Brass Background
- Flat Profile
- Aluminium
- Made in UK

Dimensions:  
• Outside Ø x (outer zone Ø) x Inside Ø



Code	Description	UOM	Price
D5249	Ø127mm (Ø121mm) x Ø66mm Ring, UK	EACH	£5.95

**Roman Ø127mm (5") Flat, Silver, Ø121mm (4¾")**

Outside diameter: Ø127mm (5")  
Zone ring outer diameter: Ø121mm (4¾")

- Roman Black Figures
- Silver Background
- Outer Minute Zone
- Flat Profile
- Aluminium
- Made in UK

Dimensions:  
• Outside Ø x (outer zone Ø) x Inside Ø



Code	Description	UOM	Price
D12462	Ø127mm (Ø121mm) x Ø74mm Ring	EACH	£4.95



**Roman Ø127mm (5") Flat, Silver, Ø121mm (4¾") Diamond Cut**

Outside diameter: Ø127mm (5")  
Zone ring outer diameter: Ø121mm (4¾")



- Roman Black Figures
- Silver Background
- 0.60mm thick diamond cut bevelled edge
- Outer Minute Zone
- Flat Profile
- Aluminium
- Made in Germany

Dimensions:  
• Outside Ø x (outer zone Ø) x Inside Ø

Code	Description	UOM	Price
D12409	Ø127mm (Ø121mm) x Ø87mm Ring	EACH	£7.95

**Roman Ø127mm (5") Flat, White, Ø110mm (4¼") With Glass & Bezel**

Outside diameter: Ø127mm (5")  
Zone ring outer diameter: Ø110mm (4¼")



- Roman Black Figures
- White Background
- Outer Minute Zone
- Flat Profile
- Aluminium
- Brass Embossed Bezel, Hinged
- Convex Glass
- Overall diameter Ø130mm

Dimensions:  
• Outside Ø x (outer zone Ø) x Inside Ø

Code	Description	UOM	Price
D37743	Ø127mm (Ø110mm) x Ø73mm Ring with Bezel & Glass	EACH	£21.60

**Roman Ø127mm (5") Flat, White, Ø121mm (4¾")**

Outside diameter: Ø127mm (5")  
Zone ring outer diameter: Ø121mm (4¾")



- Roman Black Figures
- White Background
- Outer Minute Zone
- 0.50mm Thick
- Flat Profile
- Aluminium

Dimensions:  
• Outside Ø x (outer zone Ø) x Inside Ø

Code	Description	UOM	Price
D12448	Ø127mm (Ø121mm) x Ø75mm Ring	EACH	£5.50

**Roman Ø133mm (5¼ ") Flat, Silver, Ø121mm (4¾")**

Outside diameter: Ø133mm (5¼ ")  
Zone ring outer diameter: Ø121mm (4¾")



- Roman Black Figures
- Silver Background
- Outer Minute Zone
- Flat Profile
- Aluminium
- Made in UK

Dimensions:  
• Outside Ø x (outer zone Ø) x Inside Ø

Code	Description	UOM	Price
D5252	Ø133mm (Ø121mm) x Ø66mm Ring	EACH	£6.50

**Roman Ø140mm (5½") Flat, White, Ø134mm (4¼")**

Outside diameter: Ø140mm (5½")  
Zone ring outer diameter: Ø134mm (4¼")



- Roman Black Figures
- Off White Background
- Outer & Inner Minute Zone
- Flat Profile
- Aluminium
- Made in Germany

Dimensions:  
• Outside Ø x (outer zone Ø) x Inside Ø

Code	Description	UOM	Price
D12398	Ø140mm (Ø134mm) x Ø85mm Ring	EACH	£33.95

**CHAPTER RINGS, Ø152MM (6")**

*Dimensions:  
Numerals, Outside Ø in millimetres (inches)  
Style, Colour, Zone Ring Outer Edge Ø in millimetres (inches)*

*If you require a chapter that is different in colour or style please submit an online support request under "products & stock – I can't find what I am looking for – I am looking for something else". Please specify the size required, numeral type and ring colour*

**Roman Ø152mm (6") Flat, Silver, Ø146mm (5¾")**

Outside diameter: Ø152mm (6")  
Zone ring outer diameter: Ø146mm (5¾")



- Roman Black Figures
- Silver Background
- Outer Minute Zone
- Flat Profile
- Aluminium
- Made in UK

Dimensions:  
• Outside Ø x (outer zone Ø) x Inside Ø

Code	Description	UOM	Price
D12463	Ø152mm (Ø146mm) x Ø90mm Ring	EACH	£6.95

**Roman Ø152mm (6") Flat, White, Ø146mm (5¾")**

Outside diameter: Ø152mm (6")  
Zone ring outer diameter: Ø146mm (5¾")



- Roman Black Figures
- White Background
- Outer Minute Zone
- 0.50mm Thick
- Flat Profile
- Aluminium

Dimensions:  
• Outside Ø x (outer zone Ø) x Inside Ø

Code	Description	UOM	Price
D12449	Ø152mm (Ø146mm) x Ø90mm Ring	EACH	£5.95

**Roman Ø159mm (6¼") Curved, White, Ø152mm (6")**

Outside diameter: Ø159mm (6¼")  
Zone ring outer diameter: Ø152mm (6")



- Roman Black Figures
- White Background
- Outer Minute Zone
- Slightly Curved Profile
- Aluminium
- Made in Germany

Dimensions:  
• Outside Ø x (outer zone Ø) x Inside Ø

Code	Description	UOM	Price
D7765	Ø159mm (Ø152mm) x Ø105mm Ring	EACH	£13.05

**Roman Ø159mm (6¼") Flat, Gold, Ø140mm (5½")**

Outside diameter: Ø159mm (6¼")  
Zone ring outer diameter: Ø140mm (5½")



- Roman Black Figures
- Brass Background
- Flat Profile
- Aluminium
- Made in UK

Dimensions:  
• Outside Ø x (outer zone Ø) x Inside Ø

Code	Description	UOM	Price
D5250	Ø159mm (Ø140mm) x Ø73mm Ring	EACH	£7.50

**Roman Ø152mm (6") Flat, Gold, Ø146mm (5¾")**

Outside diameter: Ø152mm (6")  
Outer zone ring diameter: Ø146mm (5¾")



- Roman Black Figures
- Brass Background
- Flat Profile
- Aluminium
- Made in UK

Dimensions:  
• Outside Ø x (outer zone Ø) x Inside Ø

Code	Description	UOM	Price
D12455	Ø152mm (Ø146mm) x Ø91mm Ring	EACH	£6.95

**Practical Clock Repairing**

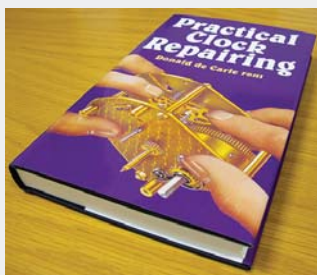

Ref: C6042 See Page: 1377

**Roman Ø159mm (6¼") Flat, White, Ø152mm (6")**

Outside diameter: Ø159mm (6¼")  
Zone ring outer diameter: Ø152mm (6")

- Roman Black Figures
- Off White Background
- Outer & Inner Minute Zone
- Flat Profile
- Aluminium
- Made in Germany



Dimensions:  
• Outside Ø x (outer zone Ø) x Inside Ø

Code	Description	UOM	Price
D12399	Ø159mm (Ø153mm) x Ø97mm Ring	EACH	£34.95

**Roman Ø172mm (6¾") Curved, White, Ø166mm (6½")**

Outside diameter: Ø172mm (6¾")  
Zone ring outer diameter: Ø166mm (6½")

- Roman Black Figures
- Off White Background
- Outer & Inner Minute Zone
- Flat Profile
- Aluminium
- Made in Germany



Dimensions:  
• Outside Ø x (outer zone Ø) x Inside Ø

Code	Description	UOM	Price
D7766	174mm (167mm) x 116mm Ring	EACH	£13.50

**Roman Ø177mm (7") Flat, Gold, Ø165mm (6½")**

Outside diameter: Ø177mm (7")  
Outer zone ring diameter: Ø165mm (6½")

- Roman Black Figures
- Brass Background
- Flat Profile
- Aluminium
- Made in UK



Dimensions:  
• Outside Ø x (outer zone Ø) x Inside Ø

Code	Description	UOM	Price
D12456	Ø177mm (Ø165mm) x Ø98mm Ring, UK	EACH	£9.50

**Roman Ø177mm (7") Flat, Gold, Ø171mm (6¾")**

Outside diameter: Ø177mm (7")  
Outer zone ring diameter: Ø171mm (6¾")

- Roman Black Figures
- Brass Background
- Flat Profile
- Aluminium
- Made in UK



Dimensions:  
• Outside Ø x (outer zone Ø) x Inside Ø

Code	Description	UOM	Price
D5251	Ø177mm (Ø171mm) x Ø98mm Ring, UK	EACH	£7.95

**Roman Ø177mm (7") Flat, Silver, Ø171mm (6¾")**

Outside diameter: Ø177mm (7")  
Outer zone ring diameter: Ø171mm (6¾")

- Roman Black Figures
- Silver Background
- Outer Minute Zone
- Flat Profile
- Aluminium
- Made in UK



Dimensions:  
• Outside Ø x (outer zone Ø) x Inside Ø

Code	Description	UOM	Price
D5254	Ø177mm (Ø171mm) x Ø93mm Ring	EACH	£9.50

**Roman Ø177mm (7") Flat, White, Ø165mm (6½")**

Outside diameter: Ø177mm (7")  
Outer zone ring diameter: Ø165mm (6½")

- Roman Black Figures
- White Background
- Outer Minute Zone
- 0.50mm Thick
- Flat Profile
- Aluminium



Dimensions:  
• Outside Ø x (outer zone Ø) x Inside Ø

Code	Description	UOM	Price
D12450	Ø177mm (Ø165mm) x Ø98mm Ring	EACH	£6.95

**CHAPTER RINGS, Ø177MM (7")**

Dimensions:  
Numerals, Outside Ø in millimetres (inches)  
Style, Colour, Zone Ring Outer Edge Ø in millimetres (inches)

If you require a chapter that is different in colour or style please submit an online support request under "products & stock – I can't find what I am looking for – I am looking for something else". Please specify the size required, numeral type and ring colour



Outside diameter: Ø177mm (7")  
Outer zone ring diameter: Ø165mm (6½")

- Roman Black Figures
- Silver Background
- Outer Minute Zone
- Flat Profile
- Aluminium
- Made in UK

Dimensions:  
• Outside Ø x (outer zone Ø) x Inside Ø

Code	Description	UOM	Price
D12464	Ø177mm (Ø165mm) x Ø98mm Ring	EACH	£9.50

**CHAPTER RINGS, Ø203MM (8")**

Dimensions:  
Numerals, Outside Ø in millimetres (inches)  
Style, Colour, Zone Ring Outer Edge Ø in millimetres (inches)

If you require a chapter that is different in colour or style please submit an online support request under "products & stock – I can't find what I am looking for – I am looking for something else". Please specify the size required, numeral type and ring colour

**Arabic Ø177mm (7") Curved, White, Ø165mm (6½")**

Outside diameter: Ø177mm (7")  
Outer zone ring diameter: Ø165mm (6½")

- Arabic Black Figures
- White Background
- Slightly Curved Profile
- Aluminium



Dimensions:  
• Outside Ø x (outer zone Ø) x Inside Ø

Code	Description	UOM	Price
D7763	Ø177mm (Ø165mm) x Ø116mm Ring	EACH	£13.95

**Roman Ø177mm (7") Flat, Silver, Ø165mm (6½") Fleur De Lys**

Outside diameter: Ø177mm (7")  
Outer zone ring diameter: Ø165mm (6½")

- Roman Black Figures
- Silver Background
- Outer Minute Zone
- Flat Profile
- Aluminium
- Made in UK



Dimensions:  
• Outside Ø x (outer zone Ø) x Inside Ø

Code	Description	UOM	Price
D47260	Ø177mm (Ø165mm) x Ø94mm Ring	EACH	£11.95

**Roman Ø203mm (8") Flat, Gold, Ø184mm (7¼")**

Outside diameter: Ø203mm (8")  
Outer zone ring diameter: Ø184mm (7¼")

- Roman Black Figures
- Brass Background
- Flat Profile
- Aluminium
- Made in UK



Dimensions:  
• Outside Ø x (outer zone Ø) x Inside Ø

Code	Description	UOM	Price
D12457	Ø203mm (Ø184mm) x Ø101mm Ring	EACH	£11.85

**Roman Ø203mm (8") Flat, Gold, Ø196mm (7¾")**

Outside diameter: Ø203mm (8")  
Outer zone ring diameter: Ø196mm (7¾")

- Roman Black Figures
- Brass Background
- Flat Profile
- Aluminium
- Made in China



Dimensions:  
• Outside Ø x (outer zone Ø) x Inside Ø

Code	Description	UOM	Price
N46045	Ø203mm (Ø196mm) x Ø128mm Ring	EACH	£3.95

**Roman Ø203mm (8") Flat, Gold, Ø196mm (7¾")**

Outside diameter: Ø203mm (8")  
Outer zone ring diameter: Ø196mm (7¾")

- Roman Black Figures
- Arabic Minute Zone
- Brass Background
- Flat Profile
- Aluminium
- Made in Germany



Dimensions:  
• Outside Ø x (outer zone Ø) x Inside Ø

Code	Description	UOM	Price
D12402	Ø203mm (Ø196mm) x Ø112mm Ring	EACH	£24.75

**Roman Ø203mm (8") Flat, Silver, Ø184mm (7¼")**

Outside diameter: Ø203mm (8")  
Outer zone ring diameter: Ø184mm (7¼")

- Roman Black Figures
- Silver Background
- Outer Minute Zone
- Flat Profile
- Aluminium
- Made in UK



Dimensions:  
• Outside Ø x (outer zone Ø) x Inside Ø

Code	Description	UOM	Price
D12465	Ø203mm (Ø184mm) x Ø101mm Ring	EACH	£14.60

**Roman Ø203mm (8") Flat, Silver, Ø196mm (7¾")**

Outside diameter: Ø203mm (8")  
Outer zone ring diameter: Ø196mm (7¾")

- Roman Black Figures
- Silver Background
- Outer Minute Zone
- Flat Profile
- Aluminium
- Made in China



Dimensions:  
• Outside Ø x (outer zone Ø) x Inside Ø

Code	Description	UOM	Price
N46050	Ø203mm (Ø196mm) x Ø128mm Ring	EACH	£3.95

**Roman Ø218mm (8½") Flat, Gold, Ø210mm (8¼")**

Outside diameter: Ø218mm (8½")  
Outer zone ring diameter: Ø210mm (8¼")

- Roman Black Figures
- Brass Background
- Flat Profile
- Aluminium
- Made in China



Dimensions:  
• Outside Ø x (outer zone Ø) x Inside Ø

Code	Description	UOM	Price
N46046	Ø218mm (Ø210mm) x Ø120mm Ring	EACH	£3.95

**Roman Ø218mm (8½") Flat, Silver, Ø210mm (8¼")**

Outside diameter: Ø218mm (8½")  
Outer zone ring diameter: Ø210mm (8¼")

- Roman Black Figures
- Silver Background
- Outer Minute Zone
- Flat Profile
- Aluminium
- Made in China



Dimensions:  
• Outside Ø x (outer zone Ø) x Inside Ø

Code	Description	UOM	Price
N46051	Ø220mm (Ø210mm) x Ø120mm Ring	EACH	£3.95

**CHAPTER RINGS, Ø228MM (9")**

Dimensions:  
*Numerals, Outside Ø in millimetres (inches)  
Style, Colour, Zone Ring Outer Edge Ø in millimetres (inches)*

*If you require a chapter that is different in colour or style please submit an online support request under "products & stock – I can't find what I am looking for – I am looking for something else". Please specify the size required, numeral type and ring colour*

**Roman Ø228mm (9") Flat, Gold, Ø210mm (8¼")**

Outside diameter: Ø228mm (9")  
Outer zone ring diameter: Ø210mm (8¼")

- Roman Black Figures
- Brass Background
- Flat Profile
- Aluminium
- Made in UK
- Dimensions:  
• Outside Ø x (outer zone Ø) x Inside Ø



Code	Description	UOM	Price
D12458	Ø228mm (Ø210mm) x Ø120mm Ring, UK	EACH	£12.15

**Roman Ø228mm (9") Flat, Silver, Ø210mm (8¼")**

Outside diameter: Ø228mm (9")  
Outer zone ring diameter: Ø210mm (8¼")

- Roman Black Figures
- Silver Background
- Outer Minute Zone
- Flat Profile
- Aluminium
- Made in UK



Dimensions:  
• Outside Ø x (outer zone Ø) x Inside Ø

Code	Description	UOM	Price
D12466	Ø228mm (Ø210mm) x Ø120mm Ring	EACH	£15.95

**Roman Ø235mm (9¼") Flat, Gold, Ø228mm (9")**

Outside diameter: Ø235mm (9¼")  
Outer zone ring diameter: Ø228mm (9")

- Roman Black Figures
- Brass Background
- Flat Profile
- Aluminium
- Made in China



Dimensions:  
• Outside Ø x (outer zone Ø) x Inside Ø

Code	Description	UOM	Price
N46047	Ø235mm (Ø228mm) x Ø138mm Ring	EACH	£3.95

**Roman Ø235mm (9¼") Flat, Silver, Ø228mm (9")**

Outside diameter: Ø235mm (9¼")  
Outer zone ring diameter: Ø228mm (9")

- Roman Black Figures
- Silver Background
- Outer Minute Zone
- Flat Profile
- Aluminium
- Made in China



Dimensions:  
• Outside Ø x (outer zone Ø) x Inside Ø

Code	Description	UOM	Price
N46052	Ø235mm (Ø228mm) x Ø138mm Ring	EACH	£3.95

**Roman Ø242mm (9½") Flat, Gold, Ø235mm (9¼")**

Outside diameter: Ø242mm (9½")  
Outer zone ring diameter: Ø235mm (9¼")

- Roman Black Figures
- Brass Background
- Flat Profile
- Aluminium
- Made in China



Dimensions:  
• Outside Ø x (outer zone Ø) x Inside Ø

Code	Description	UOM	Price
N46048	Ø242mm (Ø235mm) x 128mm Ring	EACH	£3.95

**Roman Ø242mm (9½") Flat, Gold, Ø235mm (9¼") Fancy**

Outside diameter: Ø242mm (9½")  
Outer zone ring diameter: Ø235mm (9¼")

- Roman Black Figures
- Gold Background
- Outer Minute Zone
- Flat Profile with cartouche numerals
- Aluminium
- Made in China



Dimensions:  
• Outside Ø x (outer zone Ø) x Inside Ø

Code	Description	UOM	Price
N46044	Ø242mm (Ø235mm) x Ø134mm Ring	EACH	£8.95

**Roman Ø242mm (9½") Flat, Silver, Ø235mm (9¼")**

Outside diameter: Ø242mm (9½")  
Outer zone ring diameter: Ø235mm (9¼")

- Roman Black Figures
- Silver Background
- Outer Minute Zone
- Flat Profile
- Aluminium
- Made in China



Dimensions:  
• Outside Ø x (outer zone Ø) x Inside Ø

Code	Description	UOM	Price
N46053	Ø242mm (Ø235mm) x Ø128mm Ring	EACH	£3.95

**Roman Ø242mm (9½") Flat, Silver, Ø235mm (9¼") Fancy**

Outside diameter: Ø242mm (9½")  
Outer zone ring diameter: Ø235mm (9¼")

- Roman Black Figures
- Silver Background
- Outer Minute Zone
- Flat Profile with cartouche numerals
- Aluminium
- Made in China



Dimensions:  
• Outside Ø x (outer zone Ø) x Inside Ø

Code	Description	UOM	Price
N46049	Ø242mm (Ø235mm) x 128mm Ring	EACH	£8.95

**Clock Case Restorer**



See Page: 1168

**CHAPTER RINGS, Ø254MM (10")**

Dimensions:  
Numerals, Outside Ø in millimetres (inches)  
Style, Colour, Zone Ring Outer Edge Ø in millimetres (inches)

If you require a chapter that is different in colour or style please submit an online support request under "products & stock – I can't find what I am looking for – I am looking for something else". Please specify the size required, numeral type and ring colour

**Roman Ø254mm (10") Flat, Gold, Ø228mm (9")**

Outside diameter: Ø254mm (10")  
Outer zone ring diameter: Ø228mm (9")

- Roman Black Figures
- Brass Background
- Flat Profile
- Aluminium
- Made in UK



Dimensions:  
• Outside Ø x (outer zone Ø) x Inside Ø

Code	Description	UOM	Price
D12459	Ø254mm (Ø228mm) x Ø127mm Ring	EACH	£14.25

**Roman Ø254mm (10") Flat, Silver, Ø228mm (9")**

Outside diameter: Ø254mm (10")  
Outer zone ring diameter: Ø228mm (9")

- Roman Black Figures
- Silver Background
- Outer Minute Zone
- Flat Profile
- Aluminium
- Made in UK



Dimensions:  
• Outside Ø x (outer zone Ø) x Inside Ø

Code	Description	UOM	Price
D12467	Ø254mm (Ø228mm) x Ø127mm Ring	EACH	£17.95

**Roman Ø254mm (10") Flat, Silver, Ø228mm (9")**

Outside diameter: Ø254mm (10")  
Outer zone ring diameter: ØTBA

- Roman Black Figures
- Silver Background
- Outer Minute Zone
- Flat Profile
- Aluminium
- Made in China



Dimensions:  
• Outside Ø x (outer zone Ø) x Inside Ø

Code	Description	UOM	Price
D48984	Ø254mm (ØTBAmm) x ØTBAmm Ring	EACH	£4.95

**CHAPTER RINGS, Ø305MM (12")**

Dimensions:  
Numerals, Outside Ø in millimetres (inches)  
Style, Colour, Zone Ring Outer Edge Ø in millimetres (inches)

If you require a chapter that is different in colour or style please submit an online support request under "products & stock – I can't find what I am looking for – I am looking for something else". Please specify the size required, numeral type and ring colour

**Roman Ø305mm (12") Flat, Gold, Ø274mm (10¾")**

Outside diameter: Ø305mm (12")  
Outer zone ring diameter: Ø274mm (10¾")

- Roman Black Figures
- Brass Background
- Flat Profile
- Aluminium
- Made in UK



Dimensions:  
• Outside Ø x (outer zone Ø) x Inside Ø

Code	Description	UOM	Price
D44751	Ø305mm (Ø274mm) x Ø154mm	EACH	£15.95

**Roman Ø305mm (12") Flat, Silver, Ø274mm (10¾")**

Outside diameter: Ø305mm (12")  
Outer zone ring diameter: Ø274mm (10¾")

- Roman Black Figures
- Silver Background
- Outer Minute Zone
- Flat Profile
- Aluminium
- Made in UK



Dimensions:  
• Outside Ø x (outer zone Ø) x Inside Ø

Code	Description	UOM	Price
D44749	Ø304mm (Ø274mm) x Ø154mm, UK	EACH	£15.95

**CHAPTER RINGS, Ø356MM (14")**

Dimensions:  
Numerals, Outside Ø in millimetres (inches)  
Style, Colour, Zone Ring Outer Edge Ø in millimetres (inches)

If you require a chapter that is different in colour or style please submit an online support request under "products & stock – I can't find what I am looking for – I am looking for something else". Please specify the size required, numeral type and ring colour

**Roman Ø356mm (14") Flat, Gold, Ø324mm (12¾")**

Outside diameter: Ø356mm (14")  
Outer zone ring diameter: Ø324mm (12¾")

- Roman Black Figures
- Brass Background
- Flat Profile
- Aluminium
- Made in UK



Dimensions:

- Outside Ø x (outer zone Ø) x Inside Ø

Code	Description	UOM	Price
D44752	Ø356mm (Ø324mm) x Ø176mm	EACH	£17.95

**Roman Ø356mm (14") Flat, Silver, Ø324mm (12¾")**

Chapter Rings - Flat Profile - Silver

- Roman Black Figures
- Silver Background
- Outer Minute Zone
- Flat Profile
- Aluminium
- Made in UK



Dimensions:

- Outside Ø x (outer zone Ø) x Inside Ø

Code	Description	UOM	Price
D44750	Ø356mm (Ø324mm) Ø176mm, UK	EACH	£17.95

**DIALS, Ø76MM (3")**

Dimensions:

*Numerals, Outside Ø in millimetres (inches) Style, Colour, Zone Ring Outer Edge Ø in millimetres (inches)*

*If you require a dial that is different in colour or style please submit an online support request under "products & stock - I can't find what I am looking for - I am looking for something else". Please specify the size required, numeral type and dial colour*

**Arabic Ø90mm (3½") Flat, White, Ø77mm (2¾")**

Outside diameter: Ø90mm (3½")  
Zone ring diameter: Ø77mm (2¾")

- Arabic Black Figures
- White Background
- Flat Profile
- Aluminium
- Ø10mm centre hole
- Made in Germany



Dimensions in millimetres: Outside Ø x (Zone Ring Outer Edge Ø)

Code	Description	UOM	Price
D5244	Ø90mm (3½") x Ø77mm (2¾") Dial	EACH	£15.65

**Roman Ø82mm (3¼ ") Flat, White, Ø70mm (2¾")**

Outside diameter: Ø82mm (3¼ ")  
Zone ring diameter: Ø70mm (2¾")

- Roman Black Figures
- White Background
- Flat Profile
- Aluminium
- Ø10mm centre hole
- Made in Germany



Dimensions in millimetres: Outside Ø x (Zone Ring Outer Edge Ø)

Code	Description	UOM	Price
D5237	Ø82mm (3¼ ") x Ø70mm (2¾") Dial	EACH	£15.15

**DIALS, Ø102MM (4")**

Dimensions:

*Numerals, Outside Ø in millimetres (inches) Style, Colour, Zone Ring Outer Edge Ø in millimetres (inches)*

*If you require a dial that is different in colour or style please submit an online support request under "products & stock - I can't find what I am looking for - I am looking for something else". Please specify the size required, numeral type and dial colour*

**Arabic Ø102mm (4") Flat, White, Ø88mm (3½")**

Outside diameter: Ø102mm (4")  
Zone ring diameter: Ø88mm (3½")

- Arabic Black Figures
- White Background
- Flat Profile
- Aluminium
- Ø10mm centre hole
- Made in Germany



Dimensions:

- Outside Ø in millimetres (inches) x Zone Ring Outer Edge Ø in millimetres (inches)

Code	Description	UOM	Price
D5245	Ø102mm (4") x Ø88mm (3½") Dial	EACH	£15.95

**Arabic Ø114mm (4½") Flat, White, Ø95mm (3¾")**

Outside diameter: Ø114mm (4½")  
Zone ring diameter: Ø95mm (3¾")

- Arabic Black Figures
- White Background
- Flat Profile
- Aluminium
- Ø10mm centre hole
- Polished Brass Embossed Bezel, Hinged
- Convex Glass
- Made in Germany



Dimensions:

- Outside Ø in millimetres (inches) x Zone Ring Outer Edge Ø in millimetres (inc)

Code	Description	UOM	Price
D7858	Ø114mm (4½") x Ø95mm (3¾") Dial	EACH	£27.45

**Arabic Ø114mm (4½") Flat, White, Ø102mm (4")**

Outside diameter: Ø114mm (4½")  
Zone ring diameter: Ø102mm (4")

- Arabic Black Figures
- White Background
- Flat Profile
- Aluminium
- Ø10mm centre hole
- Made in Germany



Dimensions:

- Outside Ø in millimetres (inches) x Zone Ring Outer Edge Ø in millimetres (inches)

Code	Description	UOM	Price
D5246	Ø114mm (4½") x Ø102mm (4") Dial	EACH	£19.95

**Roman Ø102mm (4") Flat, White, Ø82mm (3¼") with Bezel & Glass**

Outside diameter: Ø102mm (4")  
Zone ring diameter: Ø82mm (3¼")

- Roman Black Figures
- White Background
- Flat Profile
- Aluminium
- Ø10mm centre hole
- Polished Brass Embossed Bezel, Hinged
- Convex Glass
- Made in Germany



Dimensions:

- Outside Ø in millimetres (inches) x Zone Ring Outer Edge Ø in millimetres (inches)

Code	Description	UOM	Price
D7857	Ø102mm (4") x Ø82mm (3¼") Dial	EACH	£21.00

**Roman Ø102mm (4") Flat, White, Ø88mm (3½")**

Outside diameter: Ø102mm (4")  
Zone ring diameter: Ø88mm (3½")

- Roman Black Figures
- White Background
- Flat Profile
- Aluminium
- Ø10mm centre hole
- Made in Germany



Dimensions:

- Outside Ø in millimetres (inches) x Zone Ring Outer Edge Ø in millimetres (inches)

Code	Description	UOM	Price
D5239	Ø102mm (4") x Ø88mm (3½") Dial	EACH	£15.65

**PRICE PROMISE GUARANTEE**



**Roman Ø102mm (4") Flat, Silver, Ø102mm (4")**

Outside diameter: Ø102mm (4")  
Zone ring diameter: Ø102mm (4")

- Roman Black Figures
- Silver Background
- Flat Profile
- Aluminium
- Ø10mm centre hole
- Made in UK



Dimensions:

- Outside Ø in millimetres (inches) x Zone Ring Outer Edge Ø in millimetres (inches)

Code	Description	UOM	Price
D12469	Ø102mm (4") x Ø88mm (3½") Dial	EACH	£5.70

**Roman Ø114mm (4½") Flat, White, Ø102mm (4")**

Outside diameter: Ø114mm (4½")  
Zone ring diameter: Ø102mm (4")

- Roman Black Figures
- White Background
- Flat Profile
- Aluminium
- Ø10mm centre hole
- Made in Germany



Dimensions:

- Outside Ø in millimetres (inches) x Zone Ring Outer Edge Ø in millimetres (inches)

Code	Description	UOM	Price
D5240	Ø114mm (4½") x Ø102mm (4") Dial	EACH	£15.95

**DIALS, Ø127MM (5")**

Dimensions:

Numerals, Outside Ø in millimetres (inches) Style, Colour, Zone Ring Outer Edge Ø in millimetres (inches)

If you require a dial that is different in colour or style please submit an online support request under "products & stock – I can't find what I am looking for – I am looking for something else". Please specify the size required, numeral type and dial colour

**Roman Ø127mm (5") Flat, White, Ø120mm (4¾")**

Outside diameter: Ø127mm (5")  
Zone ring diameter: Ø120mm (4¾")

- Roman Black Figures
- Silver Background
- Flat Profile
- Aluminium
- Ø10mm centre hole
- Made in UK



Dimensions:

- Outside Ø in millimetres (inches) x Zone Ring Outer Edge Ø in millimetres (inches)

Code	Description	UOM	Price
D12470	Ø127mm (5") x Ø120mm (4¾") Dial	EACH	£6.50

**Roman Ø138mm (5½") Flat, White, Ø127mm (5")**

Outside diameter: Ø138mm (5½")  
Zone ring diameter: Ø127mm (5")

- Roman Black Figures
- Silver Background
- Flat Profile
- Aluminium
- Ø10mm centre hole
- Made in Germany



Dimensions:

- Outside Ø in millimetres (inches) x Zone Ring Outer Edge Ø in millimetres (inches)

Code	Description	UOM	Price
D5242	Ø138mm (5½") x Ø127mm (5") Dial	EACH	£25.95

**DIALS, Ø152MM (6")**

Dimensions:

Numerals, Outside Ø in millimetres (inches) Style, Colour, Zone Ring Outer Edge Ø in millimetres (inches)

If you require a dial that is different in colour or style please submit an online support request under "products & stock – I can't find what I am looking for – I am looking for something else". Please specify the size required, numeral type and dial colour

**Arabic Ø152mm (6") Flat, Silver, Ø133mm (5¼")**

Outside diameter: Ø152mm (6")  
Zone ring diameter: Ø133mm (5¼")

- Arabic Black Figures
- Silver Background
- Flat Profile
- Aluminium
- Ø10mm centre hole
- Made in UK



Dimensions:

- Outside Ø in millimetres (inches) x Zone Ring Outer Edge Ø in millimetres (inches)

Code	Description	UOM	Price
D5082	152mm (6") x 133mm (5¼") Dial	EACH	£7.95

**Arabic Ø152mm (6") Flat, Matt White, Ø133mm (5¼")**

Outside diameter: Ø152mm (6")  
Zone ring diameter: Ø133mm (5¼")

- Arabic Black Figures
- White Background
- Matt Finish
- Flat Profile
- Aluminium
- Ø10mm centre hole
- Made in UK



Dimensions:

- Outside Ø in millimetres (inches) x Zone Ring Outer Edge Ø in millimetres (inches)

Code	Description	UOM	Price
D5080	Ø152mm (6") x 133mm (5¼") Dial	EACH	£6.95

**Arabic Ø152mm (6") Flat, White, Ø133mm (5¼")**

Outside diameter: Ø152mm (6")  
Zone ring diameter: Ø133mm (5¼")

- Arabic Black figures
- Gold bezel
- White background
- Flat profile
- Aluminium
- Ø10mm centre hole
- For use with dial pans or on their own
- Made in China



Dimensions:

- Outside Ø in millimetres (inches) x Zone Ring Outer Edge Ø in millimetres (inches)

Please note: These dials will have imperfections of varying degrees in the finish and the quality will not match that of dials of a higher value hence their cost.

Code	Description	UOM	Price
D48943	Ø152mm (6") x Ø133mm (5¼") Dial	EACH	£4.95

**Arabic Ø152mm (6") Flat, White, Ø133mm (5¼"), Reverse**

Outside diameter: Ø152mm (6")  
Zone ring diameter: Ø133mm (5¼")

- Reverse numbers (backwards)
- Arabic Black Figures
- White Background
- Flat Profile
- Aluminium
- Ø10mm centre hole
- Suitable partner for our reverse quartz movement (J3138M)
- Made in UK



Dimensions:

- Outside Ø in millimetres (inches) x Zone Ring Outer Edge Ø in millimetres (inches)

Code	Description	UOM	Price
D8948	Ø152mm (6") x 133mm (5¼") Dial	EACH	£3.25

## Dial Repair Kit

See Page: 1169



**Arabic Ø165mm (6½") Raised, Fancy, Ø145mm (5¾")**

Outside diameter: Ø165mm (6½")  
Zone ring diameter: Ø145mm (5¾")



- Arabic Gold Figures
- Gold pattern at centre
- Gold bezel
- Silver background
- Raised edge
- Aluminium
- Ø10mm centre hole
- For use with dial pans or on their own
- Made in China

Dimensions:  
• Outside Ø in millimetres (inches) x Zone Ring Outer Edge Ø in millimetres (inches)

Please note: These dials will have imperfections of varying degrees in the finish and the quality will not match that of dials of a higher value hence their cost.

Code	Description	UOM	Price
D46177	Ø165mm (6½") x Ø145mm (5¾") Dial	EACH	£5.95

**Arabic Ø165mm (6½") Raised, Gold, Ø145mm (5¾")**

Outside diameter: Ø165mm (6½")  
Zone ring diameter: Ø145mm (5¾")



- Arabic black figures
- Gold bezel
- Gold background
- Raised edge
- Aluminium
- Ø10mm centre hole
- For use with dial pans or on their own
- Made in China

Dimensions:  
• Outside Ø in millimetres (inches) x Zone Ring Outer Edge Ø in millimetres (inches)

Please note: These dials will have imperfections of varying degrees in the finish and the quality will not match that of dials of a higher value hence their cost.

Code	Description	UOM	Price
D46000	Gold Bezel, Ø150mm Dial	EACH	£4.95

**Roman Ø152mm (6") Flat, Silver, Ø145mm (5¾")**

Outside diameter: Ø152mm (6")  
Zone ring diameter: Ø145mm (5¾")



- Roman Black Figures
- Silver Background
- Flat Profile
- Aluminium
- Ø10mm centre hole
- Made in UK

Dimensions:  
• Outside Ø in millimetres (inches) x Zone Ring Outer Edge Ø in millimetres (inches)

Code	Description	UOM	Price
D12471	152mm (6") x 145mm (5¾") Dial	EACH	£6.95

**Roman Ø152mm (6") Flat, White, Ø133mm (5¼")**

Outside diameter: Ø152mm (6")  
Zone ring diameter: Ø133mm (5¼")



- Roman Black Figures
- White Background
- Matt finish
- Flat Profile
- Aluminium
- Ø10mm centre hole
- Made in UK

Dimensions:  
• Outside Ø in millimetres (inches) x Zone Ring Outer Edge Ø in millimetres (inches)

Code	Description	UOM	Price
D5074	152mm (6") x 133mm (5¼") Dial	EACH	£6.95

**Roman Ø152mm (6") Flat, White, Ø133mm (5¼")**

Outside diameter: Ø152mm (6")  
Zone ring diameter: Ø133mm (5¼")



- Roman Black Figures
- White Background
- Gold bezel
- Flat profile
- Aluminium
- Ø10mm centre hole
- Made in China

Dimensions:  
• Outside Ø in millimetres (inches) x Zone Ring Outer Edge Ø in millimetres (inches)

Please note: These dials will have imperfections of varying degrees in the finish and the quality will not match that of dials of a higher value hence their cost.

Code	Description	UOM	Price
D48945	Ø152mm (6") x Ø133mm (5¼") Dial	EACH	£4.95

**Roman Ø152mm (6") Raised, White, Ø126mm (5"), Hermle**

Outside diameter: Ø152mm (6")  
Zone ring diameter: Ø126mm (5")



- Roman Black Figures
- White Background
- Brass bezel
- Raised profile
- Hermle regulator
- Aluminium
- Enamel imitation
- Ø8mm centre hole
- Includes backplate and dial mounting feet
- Hermle B020-00220, To fit 141 series calibres
- Hermle Germany

Dimensions:  
• Outside Ø in millimetres (inches) x Zone Ring Outer Edge Ø in millimetres (inches)

Code	Description	UOM	Price
H8793	Ø152mm (6") x 126mm (5")	EACH	£36.95

**Roman Ø152mm (6") Raised, White, Ø126mm (5"), Hermle**

Outside diameter: Ø152mm (6")  
Zone ring diameter: Ø126mm (5")



- Roman Black Figures
- White Background
- Brass bezel
- Raised profile
- Hermle regulator
- Aluminium
- Enamel imitation
- Ø8mm centre hole
- Includes backplate and dial mounting feet
- Hermle B020-00350, to fit 341.021 calibre
- Hermle Germany

Dimensions:  
• Outside Ø in millimetres (inches) x Zone Ring Outer Edge Ø in millimetres (inches)

Code	Description	UOM	Price
H39730	Ø152mm (6") x 126mm (5")	EACH	£36.95

**Roman Ø152mm (6") Raised, White, Ø126mm (5"), Hermle**

Outside diameter: Ø152mm (6")  
Zone ring diameter: Ø126mm (5")



- Roman Black Figures
- White Background
- Brass bezel
- Raised profile
- Hermle regulator
- Aluminium
- Enamel imitation
- Ø8mm centre hole
- Includes backplate and dial mounting feet
- Hermle B020-00280, to fit 341.021 calibre
- Hermle Germany

Dimensions:  
• Outside Ø in millimetres (inches) x Zone Ring Outer Edge Ø in millimetres (inches)

Code	Description	UOM	Price
H28868	Ø152mm (6") x 126mm (5")	EACH	£19.95

**Roman Ø152mm (6") Raised, White, Ø133mm (5¼")**

Outside diameter: Ø152mm (6")  
Zone ring diameter: Ø133mm (5¼")



- Roman Black Figures
- White Background
- Gold bezel
- Raised edge
- Aluminium
- Ø10mm centre hole
- For use with dial pans or on their own
- Made in China

Dimensions:  
• Outside Ø in millimetres (inches) x Zone Ring Outer Edge Ø in millimetres (inches)

Please note: These dials will have imperfections of varying degrees in the finish and the quality will not match that of dials of a higher value hence their cost.

Code	Description	UOM	Price
D46002	Ø152mm (6") x 133mm (5¼") Dial	EACH	£4.95



**Roman Ø152mm (6") Raised, White, Ø140mm (5½")**

Outside diameter: Ø152mm (6")  
Zone ring diameter: 140mm (5½")



- Roman Black Figures
- White Background
- Gold bezel
- Raised edge
- Aluminium
- Ø10mm centre hole
- For use with dial pans or on their own
- Made in China

Dimensions:  
• Outside Ø in millimetres (inches) x Zone Ring Outer Edge Ø in millimetres (inches)

Please note: These dials will have imperfections of varying degrees in the finish and the quality will not match that of dials of a higher value hence their cost.

Code	Description	UOM	Price
D45997	Ø152mm (6") x 140mm (5½") Dial	EACH	£4.95

**Roman Ø165mm (6½") Raised, White, Ø145mm (5¾")**

Outside diameter: Ø165mm (6½")  
Zone ring diameter: Ø145mm (5¾")



- Roman black figures
- Gold bezel
- White background
- Raised edge
- Aluminium
- Ø10mm centre hole
- For use with dial pans or on their own
- Made in China

Dimensions:  
• Outside Ø in millimetres (inches) x Zone Ring Outer Edge Ø in millimetres (inches)

Please note: These dials will have imperfections of varying degrees in the finish and the quality will not match that of dials of a higher value hence their cost.

Code	Description	UOM	Price
D46001	Ø165mm (6½") x Ø145mm (5¾") Dial	EACH	£4.95

**DIALS, Ø177MM (7")**

Dimensions:  
Numerals, Outside Ø in millimetres (inches)  
Style, Colour, Zone Ring Outer Edge Ø in millimetres (inches)

If you require a dial that is different in colour or style please submit an online support request under "products & stock - I can't find what I am looking for - I am looking for something else". Please specify the size required, numeral type and dial colour



**Arabic Ø177mm (7") Flat, Matt White, Ø158mm (6¼")**

Outside diameter: Ø177mm (7")  
Zone ring diameter: Ø158mm (6¼")



- Arabic Black Figures
- White Background
- Flat Profile
- Aluminium
- Ø10mm centre hole
- Made in UK

Dimensions:  
• Outside Ø in millimetres (inches) x Zone Ring Outer Edge Ø in millimetres (inches)

Code	Description	UOM	Price
D5081	Ø178mm (7") x Ø158mm (6¼") Dial	EACH	£8.50

**Arabic Ø177mm (7") Flat, Silver, Ø158mm (6¼")**

Outside diameter: Ø177mm (7")  
Zone ring diameter: Ø158mm (6¼")



- Arabic Black Figures
- Silver Background
- Flat Profile
- Aluminium
- Ø10mm centre hole
- Made in China

Dimensions:  
• Outside Ø in millimetres (inches) x Zone Ring Outer Edge Ø in millimetres (inches)

Please note: These dials will have imperfections of varying degrees in the finish and the quality will not match that of dials of a higher value hence their cost.

Code	Description	UOM	Price
D49224	Ø178mm (7") x Ø158mm (6¼") Dial	EACH	£5.50

**Arabic Ø177mm (7") Raised, Fancy, Ø160mm (6¼")**

Outside diameter: Ø177mm (7")  
Zone ring diameter: Ø160mm (6¼")



- Arabic Raised Gold Figures
- Gold pattern at centre
- Gold bezel
- Silver background with black detailing
- Raised edge
- Aluminium
- Ø10mm centre hole
- For use with dial pans or on their own
- Made in China

Dimensions:  
• Outside Ø in millimetres (inches) x Zone Ring Outer Edge Ø in millimetres (inches)

Please note: These dials will have imperfections of varying degrees in the finish and the quality will not match that of dials of a higher value hence their cost.

Code	Description	UOM	Price
D46003	Ø177mm (7") x 160mm (6¼") Dial	EACH	£5.95

**Arabic Ø177mm (7") Raised, White, Ø165mm (6½")**

Outside diameter: Ø177mm (7")  
Zone ring diameter: Ø160mm (6½")



- Arabic Black figures
- Gold bezel
- White background
- Raised edge
- Aluminium
- Ø10mm centre hole
- For use with dial pans or on their own
- Made in China

Dimensions:  
• Outside Ø in millimetres (inches) x Zone Ring Outer Edge Ø in millimetres (inches)

Please note: These dials will have imperfections of varying degrees in the finish and the quality will not match that of dials of a higher value hence their cost.

Code	Description	UOM	Price
D46005	Ø177mm (7") x 160mm (6½") Dial	EACH	£4.95

**Arabic Ø177mm (7") Raised, White, Ø165mm (6½")**

Outside diameter: Ø177mm (7")  
Zone ring diameter: Ø160mm (6½")



- Arabic Black figures
- Silver bezel
- White background
- Raised edge
- Aluminium
- Ø10mm centre hole
- For use with dial pans or on their own
- Made in China

Dimensions:  
• Outside Ø in millimetres (inches) x Zone Ring Outer Edge Ø in millimetres (inches)

Please note: These dials will have imperfections of varying degrees in the finish and the quality will not match that of dials of a higher value hence their cost.

Code	Description	UOM	Price
D46004	Ø177mm (7") x 160mm (6½") Dial	EACH	£4.95

**Roman Ø177mm (7") Flat, White, Ø158mm (6¼")**

Outside diameter: Ø177mm (7")  
Zone ring diameter: Ø158mm (6¼")



- Roman Black Figures
- White Background
- Flat Profile
- Aluminium
- Ø10mm centre hole
- Made in UK

Dimensions:  
• Outside Ø in millimetres (inches) x Zone Ring Outer Edge Ø in millimetres (inches)

Code	Description	UOM	Price
D5075	177mm (7") x 158mm (6¼") Dial	EACH	£8.50





**Roman Ø177mm (7") Raised, Off White, Ø152mm (6¼ ")**

Outside diameter: Ø177mm (7")  
Zone ring diameter: Ø160mm (6¼")



- Roman Black Figures
- Gold bezel
- Off white background
- Raised edge
- Aluminium
- Ø10mm centre hole
- For use with dial pans or on their own
- Made in China

Dimensions:  
• Outside Ø in millimetres (inches) x Zone Ring Outer Edge Ø in millimetres (inches)

Please note: These dials will have imperfections of varying degrees in the finish and the quality will not match that of dials of a higher value hence their cost.

Code	Description	UOM	Price
D46006	Ø177mm (7") x Ø152mm (6¼ ") Dial	EACH	£4.95

**Roman Ø177mm (7") Raised, White, Ø152mm (6"), Hermle**

Outside diameter: Ø177mm (7")  
Zone ring diameter: Ø152mm (6")



- Roman Black Figures
- White Background
- Brass bezel
- Raised profile
- Hermle regulator
- Aluminium
- Enamel imitation
- Ø8mm centre hole
- Includes backplate and dial mounting feet
- Hermle B020-00400, To fit 141 series calibres
- Hermle Germany

Dimensions:  
• Outside Ø in millimetres (inches) x Zone Ring Outer Edge Ø in millimetres (inches)

Code	Description	UOM	Price
H8794	Ø177mm (7") x Ø152mm (6") Dial	EACH	£44.95

**Roman Ø177mm (7") Raised, White, Ø152mm (6"), Hermle**

Outside diameter: Ø177mm (7")  
Zone ring diameter: Ø152mm (6")



- Roman Black Figures
- White Background
- Brass bezel
- Raised profile
- Hermle regulator
- Aluminium
- Enamel imitation
- Ø8mm centre hole
- Includes backplate and dial mounting feet
- Hermle B020-00240, To fit 241 series calibres
- Hermle Germany

Dimensions:  
• Outside Ø in millimetres (inches) x Zone Ring Outer Edge Ø in millimetres (inches)

Code	Description	UOM	Price
H39873	Hermle 241 Series (E), Ø180mm (152mm)	EACH	£58.95

**Roman Ø177mm (7") Raised, White, Ø152mm (6"), Hermle**

Outside diameter: Ø177mm (7")  
Zone ring diameter: Ø152mm (6")



- Roman Black Figures
- White Background
- Brass bezel
- Raised profile
- Hermle regulator
- Aluminium
- Enamel imitation
- Ø8mm centre hole
- Includes backplate and dial mounting feet
- Hermle B020-00420, To fit 341.021 calibres
- Hermle Germany

Dimensions:  
• Outside Ø in millimetres (inches) x Zone Ring Outer Edge Ø in millimetres (inches)

Code	Description	UOM	Price
H39872	Hermle 341.021 (E), Ø180mm (152mm)	EACH	£58.95

**Roman Ø177mm (7") Raised, White, Ø152mm (6"), Hermle**

Outside diameter: Ø177mm (7")  
Zone ring diameter: Ø152mm (6")



- Roman Black Figures
- White Background
- Brass bezel
- Raised profile
- Hermle regulator
- Aluminium
- Enamel imitation
- Ø8mm centre hole
- Includes backplate and dial mounting feet
- Hermle B020-01200, To fit 351 series calibres
- Hermle Germany

Dimensions:  
• Outside Ø in millimetres (inches) x Zone Ring Outer Edge Ø in millimetres (inches)

Code	Description	UOM	Price
H42000	Ø177mm (7") x Ø152mm (6") Dial	EACH	£58.95

**Roman Ø177mm (7") Raised, White, Ø165mm (6½ ")**

Outside diameter: Ø177mm (7")  
Zone ring diameter: Ø165mm (6½")



- Roman Black figures
- Gold bezel
- White background
- Raised edge
- Aluminium
- Ø10mm centre hole
- For use with dial pans or on their own
- Made in China

Dimensions:  
• Outside Ø in millimetres (inches) x Zone Ring Outer Edge Ø in millimetres (inches)

Please note: These dials will have imperfections of varying degrees in the finish and the quality will not match that of dials of a higher value hence their cost.

Code	Description	UOM	Price
D45998	Ø177mm (7") x Ø165mm (6½ ") Dial	EACH	£4.95

**Roman Ø185mm (7½ ") Raised, White, Ø150mm (6")**

Outside diameter: Ø185mm (7½ ")  
Zone ring diameter: Ø150mm (6")



- Roman Black figures
- Gold bezel
- White background
- Raised edge
- Aluminium
- Ø10mm centre hole
- For use with dial pans or on their own
- Made in China

Dimensions:  
• Outside Ø in millimetres (inches) x Zone Ring Outer Edge Ø in millimetres (inches)

Please note: These dials will have imperfections of varying degrees in the finish and the quality will not match that of dials of a higher value hence their cost.

Code	Description	UOM	Price
D45996	Ø185mm (7½ ") x Ø150mm (6")	EACH	£4.95

**DIALS, Ø203MM (8")**

Dimensions:  
Numerals, Outside Ø in millimetres (inches)  
Style, Colour, Zone Ring Outer Edge Ø in millimetres (inches)

If you require a dial that is different in colour or style please submit an online support request under "products & stock – I can't find what I am looking for – I am looking for something else". Please specify the size required, numeral type and dial colour

**Roman Ø203mm (8") Flat, Egg Shell (Off White), Ø177mm (7")**

Outside diameter: Ø203mm (8")  
Zone ring diameter: Ø177mm (7")



- Roman Black Figures
- Off White (egg shell) Background
- Gloss finish
- Flat Profile
- Aluminium
- Ø10mm centre hole
- Made in UK

Dimensions:  
• Outside Ø in millimetres (inches) x Zone Ring Outer Edge Ø in millimetres (inches)

Code	Description	UOM	Price
D8949	203mm (8") x 177mm (7") Dial	EACH	£11.95

**Roman Ø203mm (8") Flat, Silver, Ø177mm (7")**

Outside diameter: Ø203mm (8")  
Zone ring diameter: Ø177mm (7")



- Roman Black Figures
- Silver Background
- Flat Profile
- Aluminium
- Ø10mm centre hole
- Made in UK

**Dimensions:**

- Outside Ø in millimetres (inches) x Zone Ring Outer Edge Ø in millimetres (inches)

Code	Description	UOM	Price
<b>D12473</b>	Ø203mm (8") x Ø177mm (7") Dial	EACH	<b>£13.90</b>

**Roman Ø203mm (8") Raised, White, Ø168mm (6½"), Hermle**

Outside diameter: Ø203mm (8")  
Zone ring diameter: Ø168mm (6½")



- Roman Black Figures
- White Background
- Brass bezel
- Raised profile
- Hermle regulator
- Aluminium
- Enamel imitation
- Ø8mm centre hole
- Includes backplate and dial mounting feet
- Hermle B020-01080 to fit 241 series calibres
- Hermle Germany

**Dimensions:**

- Outside Ø in millimetres (inches) x Zone Ring Outer Edge Ø in millimetres (inches)

Code	Description	UOM	Price
<b>H42003</b>	Ø203mm (8") x Ø168mm (6½") Dial	EACH	<b>£65.95</b>

**Roman Ø203mm (8") Raised, White, Ø168mm (6½"), Hermle**

Outside diameter: Ø203mm (8")  
Zone ring diameter: Ø168mm (6½")



- Roman Black Figures
- White Background
- Brass bezel
- Raised profile
- Hermle regulator
- Aluminium
- Enamel imitation
- Ø8mm centre hole
- Includes backplate and dial mounting feet
- Hermle B020-004400 to fit 351 series calibres
- Hermle Germany

**Dimensions:**

- Outside Ø in millimetres (inches) x Zone Ring Outer Edge Ø in millimetres (inches)

Code	Description	UOM	Price
<b>H42004</b>	Hermle 351 Series (E), Ø200mm (168mm)	EACH	<b>£65.95</b>

**DIALS, Ø254MM (10")**

**Dimensions:**

*Numerals, Outside Ø in millimetres (inches) Style, Colour, Zone Ring Outer Edge Ø in millimetres (inches)*

*If you require a dial that is different in colour or style please submit an online support request under "products & stock – I can't find what I am looking for – I am looking for something else". Please specify the size required, numeral type and dial colour*

**Arabic Ø260mm (10¼") Flat, Gold, Ø229mm (9")**

Outside diameter: Ø260mm (10¼")  
Zone ring diameter: Ø229mm (9")



- Black Arabic Figures
- Gold Background
- Yellow chapter ring
- Flat Profile
- Aluminium
- Ø10mm centre hole
- Beautifully detailed
- Made in China

**Dimensions:**

- Outside Ø in millimetres (inches) x Zone Ring Outer Edge Ø in millimetres (inches)

Please note: These dials will have imperfections of varying degrees in the finish and the quality will not match that of dials of a higher value hence their cost.

Code	Description	UOM	Price
<b>D47591</b>	Ø260mm (10¼") x Ø229mm (9") Dial	EACH	<b>£5.95</b>

**Arabic Ø260mm (10¼") Flat, Gold, Ø229mm (9")**

Outside diameter: Ø260mm (10¼")  
Zone ring diameter: Ø229mm (9")



- Black Arabic Figures
- Gold Background
- Gold chapter ring
- Flat Profile
- Aluminium
- Ø10mm centre hole
- Beautifully detailed
- Made in China

**Dimensions:**

- Outside Ø in millimetres (inches) x Zone Ring Outer Edge Ø in millimetres (inches)

Please note: These dials will have imperfections of varying degrees in the finish and the quality will not match that of dials of a higher value hence their cost.

Code	Description	UOM	Price
<b>D47595</b>	Ø260mm (10¼") x Ø229mm (9") Dial	EACH	<b>£5.95</b>

**Roman Ø254mm (10") Flat, Off White/Egg Shell, Ø229mm (9")**

Outside diameter: Ø254mm (10")  
Zone ring diameter: Ø229mm (9")



- Roman Black Figures
- Off White (egg shell) Background
- Flat Profile
- Aluminium
- Ø10mm centre hole
- Made in UK

**Dimensions:**

- Outside Ø in millimetres (inches) x Zone Ring Outer Edge Ø in millimetres (inches)

Code	Description	UOM	Price
<b>D8950</b>	Ø254mm (10") x Ø230mm (9") Dial	EACH	<b>£13.25</b>

**Roman Ø254mm (10") Flat, White, Ø229mm (9")**

Outside diameter: Ø254mm (10")  
Zone ring diameter: Ø229mm (9")



- Roman Black Figures
- White Background
- Flat Profile
- Aluminium
- Ø10mm centre hole
- Made in UK

**Dimensions:**

- Outside Ø in millimetres (inches) x Zone Ring Outer Edge Ø in millimetres (inches)

Code	Description	UOM	Price
<b>D5077</b>	Ø254mm (10") x Ø229mm (9") Dial	EACH	<b>£10.95</b>

**Roman Ø260mm (10¼") Flat, Gold, Ø229mm (9")**

Outside diameter: Ø260mm (10¼")  
Zone ring diameter: Ø229mm (9")



- Black Roman Figures
- Gold Background
- Yellow chapter ring
- Flat Profile
- Aluminium
- Ø10mm centre hole
- Beautifully detailed
- Made in China

**Dimensions:**

- Outside Ø in millimetres (inches) x Zone Ring Outer Edge Ø in millimetres (inches)

Please note: These dials will have imperfections of varying degrees in the finish and the quality will not match that of dials of a higher value hence their cost.

Code	Description	UOM	Price
<b>D47592</b>	Ø260mm (10¼") x Ø229mm (9") Dial	EACH	<b>£5.95</b>

**Roman Ø260mm (10¼") Flat, Gold, Ø229mm (9")**

Outside diameter: Ø260mm (10¼")  
Zone ring diameter: Ø229mm (9")



- Black Roman Figures
- Gold Background
- Gold chapter ring
- Flat Profile
- Aluminium
- Ø10mm centre hole
- Beautifully detailed
- Made in China

**Dimensions:**

- Outside Ø in millimetres (inches) x Zone Ring Outer Edge Ø in millimetres (inches)

Please note: These dials will have imperfections of varying degrees in the finish and the quality will not match that of dials of a higher value hence their cost.

Code	Description	UOM	Price
<b>D47596</b>	Ø260mm (10¼") x Ø229mm (9") Dial	EACH	<b>£5.95</b>

## DIALS, Ø305MM (12")

**Dimensions:**

Numerals, Outside Ø in millimetres (inches)  
Style, Colour, Zone Ring Outer Edge Ø in millimetres (inches)

If you require a dial that is different in colour or style please submit an online support request under "products & stock – I can't find what I am looking for – I am looking for something else". Please specify the size required, numeral type and dial colour

### Roman Ø305mm (12") Flat, Off White/Egg Shell, Ø275mm (10¾")

Outside diameter: Ø305mm (12")  
Zone ring diameter: Ø275mm (10¾")

- Roman Black Figures
- Off White (egg shell) Background
- Flat Profile
- Aluminium
- Ø10mm centre hole
- Made in UK

**Dimensions:**

- Outside Ø in millimetres (inches) x Zone Ring Outer Edge Ø in millimetres (inches)

Code	Description	UOM	Price
D5236	305mm (12") x 275mm (10¾") Dial	EACH	£14.50
Price breaks available, see website			



### Roman Ø305mm (12") Flat, White, Ø265mm (10½")

Outside diameter: Ø305mm (12")  
Zone ring diameter: Ø265mm (10½")

- Roman Black Figures
- White Background
- Gold bezel
- Flat profile
- Aluminium
- Ø10mm centre hole
- Made in China

**Dimensions:**

- Outside Ø in millimetres (inches) x Zone Ring Outer Edge Ø in millimetres (inches)

Please note: These dials will have imperfections of varying degrees in the finish and the quality will not match that of dials of a higher value hence their cost.

Code	Description	UOM	Price
D48944	Ø305mm (12") x Ø265mm (10½") Dial	EACH	£5.50



### Roman Ø305mm (12") Flat, White, Ø275mm (10¾")

Outside diameter: Ø305mm (12")  
Zone ring diameter: Ø275mm (10¾")

- Roman Black Figures
- White Background
- Flat Profile
- Aluminium
- Ø10mm centre hole



- Made in UK

**Dimensions:**

- Outside Ø in millimetres (inches) x Zone Ring Outer Edge Ø in millimetres (inches)

Code	Description	UOM	Price
D5078	Ø305mm (12") x Ø275mm (10¾") Dial	EACH	£12.65

## DIALS, Ø340MM (13")

**Dimensions:**

Numerals, Outside Ø in millimetres (inches)  
Style, Colour, Zone Ring Outer Edge Ø in millimetres (inches)

If you require a dial that is different in colour or style please submit an online support request under "products & stock – I can't find what I am looking for – I am looking for something else". Please specify the size required, numeral type and dial colour

### Arabic Ø340mm (13½") Flat, Gold, Ø305mm (12")

Outside diameter: Ø340mm (13½")  
Zone ring diameter: Ø305mm (12")

- Arabic Roman Figures
- Gold Background
- Flat Profile
- Aluminium
- Ø10mm centre hole
- Beautifully detailed
- Made in China

**Dimensions:**

- Outside Ø in millimetres (inches) x Zone Ring Outer Edge Ø in millimetres (inches)

Please note: These dials will have imperfections of varying degrees in the finish and the quality will not match that of dials of a higher value hence their cost.

Code	Description	UOM	Price
D47593	Ø340mm (13½") x Ø305mm (12") Dial	EACH	£5.95



### Roman Ø340mm (13½") Flat, Gold, Ø305mm (12")

Outside diameter: Ø340mm (13½")  
Zone ring diameter: Ø305mm (12")

- Black Roman Figures
- Gold Background
- Flat Profile
- Aluminium
- Ø10mm centre hole
- Beautifully detailed
- Made in China

**Dimensions:**

- Outside Ø in millimetres (inches) x Zone Ring Outer Edge Ø in millimetres (inches)

Please note: These dials will have imperfections of varying degrees in the finish and the quality will not match that of dials of a higher value hence their cost.

Code	Description	UOM	Price
D47594	Ø340mm (13½") x Ø305mm (12") Dial	EACH	£5.95



## DIALS, Ø356MM (14")

**Dimensions:**

Numerals, Outside Ø in millimetres (inches)  
Style, Colour, Zone Ring Outer Edge Ø in millimetres (inches)

If you require a dial that is different in colour or style please submit an online support request under "products & stock – I can't find what I am looking for – I am looking for something else". Please specify the size required, numeral type and dial colour

### Roman Ø356mm (14") Flat, White, Ø305mm (12")

- Roman Black Figures
- White Background
- Matt finish
- Flat Profile
- Aluminium
- Ø10mm centre hole

**Dimensions in millimetres:**

- Outside Ø x (Zone Ring Outer Edge Ø)

Code	Description	UOM	Price
D5079	Ø356mm (14") x Ø305mm (12") Dial	EACH	£14.95



## DIALS, CARRIAGE CLOCK

### Carriage Clock Dials

Carriage Clock (metal) Dials

Aluminium dial with black roman numerals on gloss white finish. Can be easily trimmed to size.

**Dimensions:**

- 0.50mm Thickness
- 90mm Width
- 140mm Height
- Ø47mm Minute Zone (outer edge)
- 5mm Centre Hole

Dimensions: Width x Height x (Zone Ø)

Code	Description	UOM	Price
D5229	90 x 140mm (47mm) Dial	EACH	£8.95



## DIALS, PAPER

### Paper Dials, Adhesive Backed



Clock Dials - Paper - Adhesive Backed - Ansonia

- Ansonia paper dials
- For Ansonia brand clocks
- Roman numerals
- With or without calendar

- White background
- Adhesive backed

Dimensions:

- Outer minute zone edge Ø mm (inches) Dial (actual paper size)

Code	Description	UOM	Price
D31712R	Ø228mm (9") Dial (255mm), Roman	PACK*5	£3.95
D31714	Ø228mm (9") Dial (255mm) with Calendar, Roman	PACK*5	£4.95
D47491	Ø265mm (10½") Dial (305mm) Arabic	PACK*5	£4.50

## Arabic Numerals

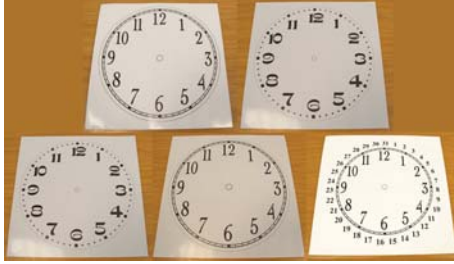

Clock Dials - Paper - Adhesive Backed - Plain

- Paper dials
- Arabic numerals
- White background
- Adhesive backed
- 11 inch with or without calendar

Dimensions:

- Outer minute zone edge Ø mm (inches)\* Dial (actual paper size)

\*Calendar dial is the measurement of the outer calendar edge

Code	Description	UOM	Price
D45584	Ø128mm (5") Dial (150mm)	PACK*5	£2.95
D45594	Ø180mm (7") Dial (200mm)	PACK*5	£2.95
D45587	Ø220mm (8¾") Dial (280mm)	PACK*5	£4.50
D45588	Ø280mm (11") Dial (300mm)	PACK*5	£4.95
D45582	Ø280mm (11") Dial (300mm) with Calendar	PACK*5	£4.50
D48792	Ø305mm (12") Dial (TBA)	PACK*5	£4.95

## Fancy

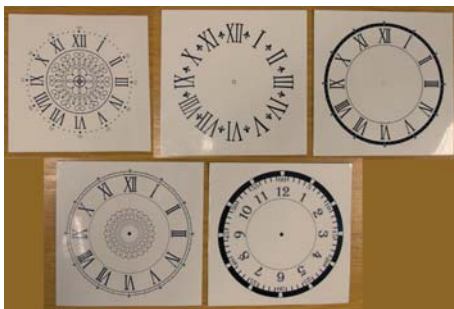

Clock Dials - Paper - Adhesive Backed - Fancy

- Assorted paper dials
- Pack\*5
- Arabic & Roman numerals
- White background
- Adhesive backed

Dimensions:

- Outer minute zone edge Ø mm (inches) Dial (actual paper size)

Code	Description	UOM	Price
D47493	Ø135mm (5") Dial (152mm)	PACK*5	£1.95

## Roman Numerals

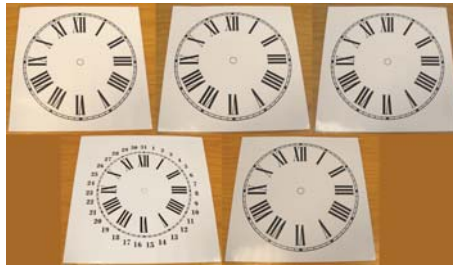

Clock Dials - Paper - Adhesive Backed - Plain

- Paper dials
- Roman numerals
- White background
- Adhesive backed
- 10 inch with calendar

Dimensions:

- Outer minute zone edge Ø mm (inches)\* Dial (actual paper size)

\*Calendar dial is the measurement of the outer calendar edge

Code	Description	UOM	Price
D45574	Ø128mm (5") Dial (150mm)	PACK*5	£2.95
D45592	Ø180mm (7") Dial (200mm)	PACK*5	£3.95
D45577	Ø220mm (8¾") Dial (280mm)	PACK*5	£4.50
D45583	Ø260mm (10") Dial (300mm) with Calendar	PACK*5	£4.95
D47492	Ø265mm (10½") Dial (300mm)	PACK*5	£4.50
D45578	Ø280mm (11") Dial (300mm)	PACK*5	£4.95
D48791	Ø305mm (12") Dial (TBA)	PACK*5	£4.95

## Seikosha

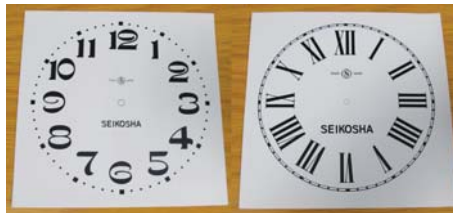

Clock Dials - Paper - Adhesive Backed - Seikosha

- Seikosha paper dials
- For Seikosha brand clocks
- Roman or arabic numerals
- White background
- Adhesive backed

Dimensions:

- Outer minute zone edge Ø mm (inches) Dial (actual paper size) Numerals

Code	Description	UOM	Price
D31710R	Ø128mm (5") Dial (150mm) Roman	PACK*5	£2.95
D31711A	Ø180mm (7") Dial (200mm) Arabic	PACK*5	£3.95
D31711R	Ø180mm (7") Dial (200mm) Roman	PACK*5	£3.95
D31712A	Ø228mm (9") Dial (255mm) Arabic	PACK*5	£3.95
D31713A	Ø280mm (11") Dial (300mm) Arabic	PACK*5	£4.95

## Seth Thomas

Clock Dials - Paper - Adhesive Backed - Seth Thomas

- Seth Thomas paper dials
- For Seth Thomas brand clocks
- Roman numerals
- White background
- Adhesive backed

Dimensions:



- Outer minute zone edge Ø (actual paper size)

Code	Description	UOM	Price
D31713R	Ø280mm (11") Dial (300mm)	PACK*5	£4.95

## DIALS, SQUARE

## Hermle Square Dials



Clock Dials - Hermle - Arch Topped

- Brass coloured aluminium
- Silver coloured hour ring
- Grained centre

Hermle Part Numbers:

- H9463 = B218.0455001 (with "Tempus Fugit" globe plaque)
- HERB2180009002 = B218.0009002 (with plain arch)
- H9464 = B218.0456001 (with "Tempus Fugit" globe plaque)

Dimensions:

- A = Overall Height (including Arch)
- B = Overall Width
- C = Outer Minute Zone Ø

Code	Description	UOM	Price
H9463	(A) 330 x (B) 250, (C) Ø205mm Dial	EACH	£169.95
HERB2180009002	(A) 330 x (B) 250, (C) Ø205mm Dial	EACH	£165.95
H9464	(A) 375 x (B) 280, (C) Ø250mm Dial	EACH	£169.95

## Arabic (Black on Gold)

- 330 x 330mm (width x height)
- Ø260mm outer numeral zone ring edge
- Black arabic numerals
- Spun brass colour chapter ring
- Spun brass colour background
- Can be cut to fit
- Hand shaft hole Ø10mm
- Aluminium sheet
- Beautifully detailed
- Can be cut to fit
- Made in China



Please note: These dials will have imperfections of varying degrees in the finish and the quality will not match that of dials of a higher value hence their cost.

Code	Description	UOM	Price
D47585	330 x 330mm Square Dial	EACH	£9.95

## Arabic (Black on Gold), Moon Phase Graphic

- 300 x 400mm (width x height)
- Ø230mm outer numeral zone ring edge
- Black arabic numerals
- Brass colour chapter ring
- Brass colour background
- Moon phase graphic
- Hand shaft hole Ø10mm
- Aluminium sheet
- Beautifully detailed
- Can be cut to fit



**PRICE PROMISE  
GUARANTEE**

• Made in China

Please note: These dials will have imperfections of varying degrees in the finish and the quality will not match that of dials of a higher value hence their cost.

Code	Description	UOM	Price
D47590	300 x 400mm Square Dial	EACH	£9.95

**Arabic (Black on Gold), Tempus Fugit**

- 300 x 400mm (width x height)
- Ø230mm outer numeral zone ring edge
- Black arabic numerals
- Brass colour chapter ring
- Brass colour background
- Tempus Fugit plaque
- Hand shaft hole Ø10mm
- Aluminium sheet
- Beautifully detailed
- Can be cut to fit
- Made in China



Please note: These dials will have imperfections of varying degrees in the finish and the quality will not match that of dials of a higher value hence their cost.

Code	Description	UOM	Price
D45994	300 x 400mm Square Dial	EACH	£9.95

**Arabic (Black on Silver), Moon Phase Graphic**

- 300 x 400mm (width x height)
- Ø230mm outer numeral zone ring edge
- Black arabic numerals
- Silver colour chapter ring
- Brass colour background
- Moon phase graphic only
- Can be cut to fit
- Hand shaft hole Ø10mm
- Aluminium sheet
- Beautifully detailed
- Made in China



Please note: These dials will have imperfections of varying degrees in the finish and the quality will not match that of dials of a higher value hence their cost.

Code	Description	UOM	Price
D47586	300 x 400mm Square Dial	EACH	£9.95

**Arabic (Gold on Gold), Moon Phase Movable, Hermle 451**

- 280 x 396mm (width x height)
- Ø240mm outer numeral zone ring edge
- Gold Arabic numerals
- Spun brass colour chapter ring
- Brass colour background
- Working (movable) moon phase function
- With small seconds sub dial
- With hole for chime/night silence lever
- Hand shaft hole Ø10mm
- With 4 mounting posts (Ø6 x 45mm)
- Titanium plated stainless steel
- Beautifully detailed
- Will fit Hermle 451 series movements
- Made in China



Code	Description	UOM	Price
D49225	280 x 396 Dial with Movable Moon Disc	EACH	£59.95

**Arabic (Gold on Gold), Moon Phase Movable, Hermle 1161**

- 280 x 396mm (width x height)
- Ø240mm outer numeral zone ring edge
- Gold Arabic numerals
- Spun brass colour chapter ring
- Brass colour background
- Working (movable) moon phase function
- With small seconds sub dial
- With hole for chime/night silence lever
- Hand shaft hole Ø10mm
- With 4 mounting posts (Ø6 x 45mm)
- Winding hole configuration 4 (see additional image)
- Titanium plated stainless steel
- Beautifully detailed
- Will fit Hermle 1161 series movements
- Made in China



Code	Description	UOM	Price
D48939	280 x 396 Dial with True Moon Phase	EACH	£59.95

**Arabic (Gold on Silver), Moon Phase Movable, Hermle 451**

- 280 x 396mm (width x height)
- Ø240mm outer numeral zone ring edge
- Gold Arabic numerals
- Silver colour chapter ring
- Brass colour background
- Working (movable) moon phase function
- With small seconds sub dial
- With hole for chime/night silence lever
- Hand shaft hole Ø10mm
- With 4 mounting posts (Ø6 x 45mm)
- Titanium plated stainless steel
- Beautifully detailed
- Will fit Hermle 451 series movements
- Made in China



Code	Description	UOM	Price
D49227	280 x 396 Dial with Movable Moon Disc	EACH	£65.95

**Arabic (Gold on Silver), Moon Phase Movable, Hermle 1161**

- 280 x 396mm (width x height)
- Ø240mm outer numeral zone ring edge
- Gold Arabic numerals
- Silver colour chapter ring
- Brass colour background
- Working (movable) moon phase function
- With small seconds sub dial
- With hole for chime/night silence lever
- Hand shaft hole Ø10mm
- Winding hole configuration 4 (see additional image)
- With 4 mounting posts (Ø6 x 45mm)
- Titanium plated stainless steel
- Beautifully detailed
- Will fit Hermle 1161 series movements
- Made in China



Code	Description	UOM	Price
D48941	280 x 396 Dial with Movable Moon Disc	EACH	£65.95

**Roman (Black on Gold), Moon Phase Graphic**

- 300 x 400mm (width x height)
- Ø230mm outer numeral zone ring edge
- Black roman numerals
- Spun brass colour chapter ring
- Brass colour background
- Moon phase graphic
- Hand shaft hole Ø10mm
- Aluminium sheet
- Beautifully detailed
- Can be cut to fit
- Made in China



Please note: These dials will have imperfections of varying degrees in the finish and the quality will not match that of dials of a higher value hence their cost.

Code	Description	UOM	Price
D47584	300 x 400mm Square Dial	EACH	£9.95

**Roman (Black on Silver), Moon Phase Graphic**

- 300 x 400mm (width x height)
- Ø230mm outer numeral zone ring edge
- Black roman numerals
- Silver colour chapter ring
- Brass colour background
- Moon phase graphic
- Hand shaft hole Ø10mm
- Aluminium sheet
- Beautifully detailed
- Can be cut to fit
- Made in China



Please note: These dials will have imperfections of varying degrees in the finish and the quality will not match that of dials of a higher value hence their cost.

Code	Description	UOM	Price
D47587	300 x 400mm Square Dial	EACH	£9.95

**Roman (Black on White), Moon Phase Graphic**

- 300 x 400mm (width x height)
- Ø230mm outer numeral zone ring edge
- Black roman numerals
- White colour chapter ring
- Brass colour background
- Moon phase graphic
- Hand shaft hole Ø10mm
- Aluminium sheet
- Beautifully detailed
- Can be cut to fit
- Made in China



Please note: These dials will have imperfections of varying degrees in the finish and the quality will not match that of dials of a higher value hence their cost.

Code	Description	UOM	Price
D45995	300 x 400mm Square Dial	EACH	£9.95



Additional photos on our website.

**Roman (Black Cartouche on Gold), Moon Phase Graphic**

- 300 x 400mm (width x height)
- Ø230mm outer numeral zone ring edge
- Cartouche Roman numerals
- Spun brass colour chapter ring
- Brass colour background
- Moon phase graphic
- Hand shaft hole Ø10mm
- Aluminium sheet
- Beautifully detailed
- Can be cut to fit
- Made in China



Please note: These dials will have imperfections of varying degrees in the finish and the quality will not match that of dials of a higher value hence their cost.

Code	Description	UOM	Price
D47589	300 x 400mm Square Dial	EACH	£14.95

**Roman (Black Cartouche on Gold), Moon Phase Movable, Hermle 451**

- 280 x 396mm (width x height)
- Ø240mm outer numeral zone ring edge
- Cartouche Roman numerals
- Spun brass colour chapter ring
- Brass colour background
- Working (movable) moon phase function
- With small seconds sub dial
- With hole for chime/night silence lever
- Hand shaft hole Ø10mm
- With 4 mounting posts (Ø6 x 45mm)
- Titanium plated stainless steel
- Beautifully detailed
- Will fit Hermle 451 series movements
- Made in China



Code	Description	UOM	Price
D49226	280 x 396 Dial with Movable Moon Disc	EACH	£59.95

**Roman (Black Cartouche on Gold), Moon Phase Movable, Hermle 1161**

- 280 x 396mm (width x height)
- Ø240mm outer numeral zone ring edge
- Cartouche Roman numerals
- Spun brass colour chapter ring
- Brass colour background
- Working (movable) moon phase function
- With small seconds sub dial
- With hole for chime/night silence lever
- Hand shaft hole Ø10mm
- With 4 mounting posts (Ø6 x 45mm)
- Winding hole configuration 4 (see additional image)
- Titanium plated stainless steel
- Beautifully detailed
- Will fit Hermle 1161 series movements
- Made in China



Code	Description	UOM	Price
D48940	280 x 396 Dial with Movable Moon Disc	EACH	£59.95

**Roman (Gold on Gold), Moon Phase Graphic**

- 300 x 400mm (width x height)
- Ø230mm outer numeral zone ring edge
- Gold roman numerals
- Spun brass colour chapter ring
- Brass colour background
- Moon phase graphic
- Hand shaft hole Ø10mm
- Aluminium sheet
- Beautifully detailed
- Can be cut to fit
- Made in China



Please note: These dials will have imperfections of varying degrees in the finish and the quality will not match that of dials of a higher value hence their cost.

Code	Description	UOM	Price
D47588	300 x 400mm Square Dial	EACH	£9.95

**Roman (Gold on Silver), Moon Phase Movable, Hermle 451**

- 280 x 396mm (width x height)
- Ø240mm outer numeral zone ring edge
- Gold Roman numerals
- Silver colour chapter ring
- Brass colour background
- Working (movable) moon phase function
- With small seconds sub dial
- With hole for chime/night silence lever
- Hand shaft hole Ø10mm
- With 4 mounting posts (Ø6 x 45mm)
- Titanium plated stainless steel
- Beautifully detailed
- Will fit Hermle 451 series movements
- Made in China



Code	Description	UOM	Price
D49228	280 x 396 Dial with Movable Moon Disc	EACH	£65.95

**Roman (Gold on Silver), Moon Phase Movable, Hermle 1161**

- 280 x 396mm (width x height)
- Ø240mm outer numeral zone ring edge
- Gold Roman numerals
- Silver colour chapter ring
- Brass colour background
- Working (movable) moon phase function
- With small seconds sub dial
- With hole for chime/night silence lever
- Hand shaft hole Ø10mm
- With 4 mounting posts (Ø6 x 45mm)
- Winding hole configuration 4 (see additional image)
- Titanium plated stainless steel
- Beautifully detailed
- Will fit Hermle 1161 series movements
- Made in China



Code	Description	UOM	Price
D48942	280 x 396 Dial with Movable Moon Disc	EACH	£65.95

**MOON DISCS**

**Moon Discs**



- Ø180mm moon disc
- Aluminium disc
- Plastic gear wheels
- Metal mounting bracket

Code	Description	UOM	Price
M47681	Ø180mm Moon Disc	EACH	£12.95

**DIAL DECORATIONS & FIXINGS**

For clock case & dial decoration & embellishment

Finely cast spandrels using traditional, precision-machined models which have excellent detail and surface quality. Excellent and suitable for the production of new and the restoring of old clock cases, dials etc.

**Brads (Fixing Pins)**



Small Brads (Pins) - Assorted (50gm)

For pinning bezels, dials and ornaments etc to wooden clock cases etc.

- Assorted
- 50gm Approx.
- Brass plated
- Made in Germany

Code	Description	UOM	Price
P8971	Brads Small (Pins) Assorted	50G	£13.95

**Dial Pegs (Hardwood), English Dial**

English Dial, Fusee - Wall Clock Hardwood Pegs

- Turned, tapered
- Hardwood
- Unfinished
- May need to be adapted to suit your requirement
- See website "more info" for specification

Additional photos on our website.

### Wall Clock Hardwood Peg



- 80mm overall
- Head diameter Ø23mm
- Plug taper from Ø13 to 10mm
- Pack\*2

Code	Description	UOM	Price
P39693	Wall Clock Hardwood Peg	PACK*2	£2.50

### Wall Clock Hardwood Peg, Made in UK



- Turned, Tapered
- Hardwood
- 80mm overall
- Maximum taper Ø10mm
- Made in UK

Code	Description	UOM	Price
P1108	Wall Clock Hardwood Peg, Made in UK	EACH	£2.95
Price breaks available, see website			

### Keyhole Grommets, Round



#### Clock Dial Keyhole Grommets

Use these brass grommets to add the finishing touch to your dial. Ideal to mask the rough edge on new holes or restorations. Simply fold back the crimps to hold in place.

- Brass or nickel
- Suitable for all clocks

#### Dimensions:

- Outer bezel diameter (hole diameter)

Code	Description	UOM	Price
C4948	Ø13mm (Ø10mm) Brass	PACK*100	£5.95
C7868	Ø12mm Brass, Made in Germany	PACK*6	£5.50
C40540	Ø13mm (Ø10mm) Nickel	PACK*100	£5.95
C32038	Ø15mm (Ø12mm) Brass	PACK*100	£7.95



### Keyhole Grommets, Square

- For redundant winding holes
- Plate size: Ø20mm
- Winding hole fitting: 4mm square
- Steel



Code	Description	UOM	Price
S47503	Dummy Winding Square	EACH	£1.95

### Mask Ø130mm (Brass)



- Ø130mm overall diameter
- Solid brass, hand carved
- 65g

Code	Description	UOM	Price
A47675	Ø130mm Dial Applique	EACH	£29.95

### Mask Ø130mm (Brass Colour)



- Ø130mm overall diameter
- Solid cast zinc alloy
- Brass colour
- 115g

Code	Description	UOM	Price
A47673	Ø130mm Dial Applique	EACH	£4.95

### Mask Ø130mm (Brass Colour)



- Ø130mm overall diameter
- Brass coloured aluminium
- Brass colour
- 50g

Code	Description	UOM	Price
A48933	Ø130mm Dial Applique	EACH	£1.95

### Mask Ø130mm (Brass Colour)



- Ø130mm overall diameter
- Solid cast zinc alloy
- Brass colour
- 115g

Code	Description	UOM	Price
A47671	Ø130mm Dial Applique	EACH	£4.95

### Mask Ø140mm (Brass Colour)



- Ø140mm overall diameter
- Stamped & etched aluminium
- Brass colour
- 30g

Code	Description	UOM	Price
A47670	Ø140mm Dial Applique	EACH	£4.95

**Hammers  
&  
Mallets**  
See Page 905

**Mask Ø140mm (Brass Colour)**



- Ø140mm overall diameter
- Stamped & etched aluminium
- Brass colour
- 30g

Code	Description	UOM	Price
A47674	Ø140mm Dial Mask	EACH	£2.95

**Mask Ø140mm (Brass Colour)**



- Ø140mm overall diameter
- Solid cast zinc alloy
- Brass colour
- 145g

Code	Description	UOM	Price
A47672	Ø140mm Dial Applique	EACH	£4.95

**Plaque, Tempus Fugit (Gold)**

Tempus Fugit Plaque - Round

- Ø70mm
- Aluminium Gold Colour with Black
- Satin Finish
- Printed Design
- Slightly Convex



Code	Description	UOM	Price
E7776	Tempus Fugit Plaque, Gold	EACH	£4.95

**Plaque, Tempus Fugit (Silver)**

Tempus Fugit Plaque - Round

- Ø70mm
- Aluminium Silver Colour with Black
- Satin Finish
- Printed Design
- Slightly Convex



Code	Description	UOM	Price
P46055	Tempus Fugit Plaque	EACH	£1.25
E7775	Tempus Fugit Plaque, Silver	EACH	£4.95

**Plaque, Tempus Fugit (White)**

Tempus Fugit Plaque - Round

- Ø45mm
- White back ground with black writing
- Supplied with gold ornate frame
- Printed Design
- Slightly Convex
- Aluminium



Code	Description	UOM	Price
P46054	Ø45mm Tempus Fugit Plaque	EACH	£1.25

**Plaque, Tempus Fugit (Ornate)**

Tempus Fugit Plaque - Oval

- Solid Brass
- Oval
- Ornate
- Antique lacquered
- Dimensions: 49mm x 31mm



Code	Description	UOM	Price
E8323	Tempus Fugit Plaque, Ornate	EACH	£3.40

**Spandrel, Break Arch 60 x 45mm (Aluminium)**

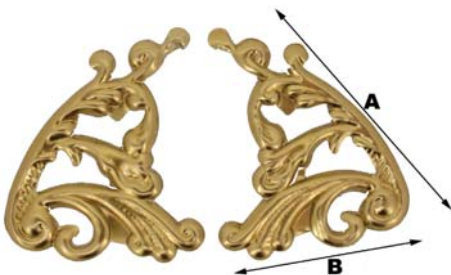

Clock Case - Break Arch Spandrels

- A = 60mm
- B = 45mm
- "Break Arch" Spandrel
- Supplied in Pairs
- Pressed aluminium
- Brass colour
- Made in China

Code	Description	UOM	Price
C47650	46mm corner	PAIR	£1.95

**Spandrel, Break Arch 70 x 35mm (Plastic)**

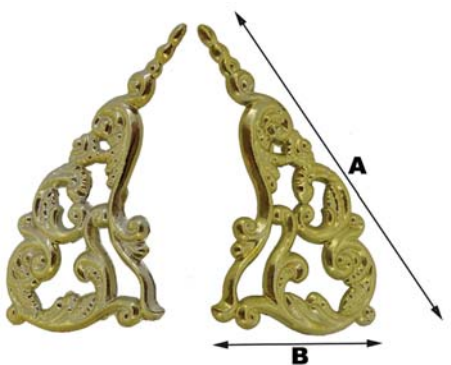

Clock Case - Break Arch Spandrels

- A = 70mm
- B = 35mm
- "Break Arch" Spandrel
- Supplied in Pairs
- Plastic

- Brass colour
- Made in China

Code	Description	UOM	Price
C47659	Break Arch Spandrels	PAIR	£1.95

**Spandrel, Break Arch 70 x 50mm (Brass) E.U Made**

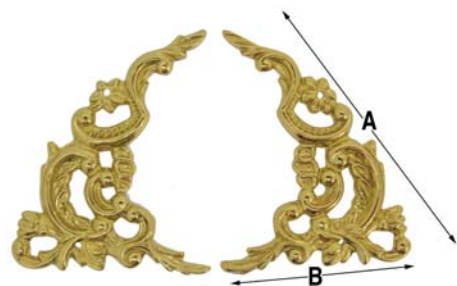

Clock Case - Break Arch Spandrels

- A = 70mm
- B = 50mm
- Brass "Break Arch" Spandrel
- with Fixing Holes
- Supplied in Pairs
- Cast brass
- Made in E.U

Code	Description	UOM	Price
E8322	Break Arch Spandrels	PAIR	£8.95

**Spandrel, Corner 35 x 45mm (Brass) E.U Made**

Clock Case - Corner Spandrel

- A = 35mm
- B = 45mm
- Brass Spandrel
- Pressed brass
- with Fixing Holes
- Made in E.U

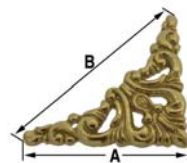

Code	Description	UOM	Price
E5112	35 x 45mm Corner Spandrel	EACH	£2.95

**Spandrel, Corner 45 x 62mm (Brass) E.U Made**

Clock Case - Corner Spandrel

- A = 45mm
- B = 62mm
- Brass Spandrel
- Pressed brass
- With Fixing Holes
- Made in E.U

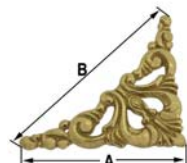

Code	Description	UOM	Price
E5113	45 x 62mm Corner Spandrel	EACH	£3.15
Price breaks available, see website			

**Spandrel, Corner 52 x 75mm (Brass) E.U Made**

Clock Case - Corner Spandrel

- A = 52mm
- B = 75mm
- Brass Spandrel
- Pressed brass
- with Fixing Holes
- Made in E.U

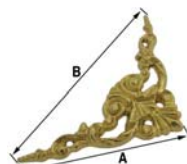

Code	Description	UOM	Price
E5114	52 x 75mm Corner Spandrel	EACH	£4.50



**Spandrel, Corner 55 x 76mm (Brass) E.U Made**

Clock Case - Corner Spandrel

- A = 55mm
- B = 76mm
- Brass Spandrel
- with Fixing Holes

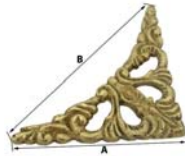

Code	Description	UOM	Price
E39706	55 x 76mm Corner Spandrel	EACH	£2.50

**Spandrel, Corner 55 x 76mm (Brass) E.U Made**



Clock Case - Corner Spandrel

- A = 55mm
- B = 76mm
- Brass Spandrel
- with Fixing Holes

Code	Description	UOM	Price
E39705	55 x 76mm Corner Spandrel	EACH	£2.50

**Spandrel, Corner 55 x 76mm (Brass) E.U Made**

Clock Case - Corner Spandrel

- A = 55mm
- B = 76mm
- Brass Spandrel
- Pressed brass
- with Fixing Holes

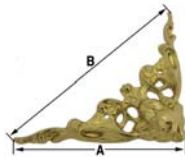

Code	Description	UOM	Price
E5115	55 x 76mm Corner Spandrel	EACH	£4.10

**Spandrel, Corner 57 x 81mm (Brass) E.U Made**

Clock Case - Corner Spandrel

- A = 57mm
- B = 81mm
- Brass Spandrel
- Pressed brass
- with Fixing Holes
- Made in E.U

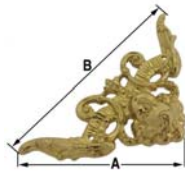

Code	Description	UOM	Price
E5110	57 x 81mm Corner Spandrel	EACH	£4.55

**Spandrel, Corner 60 x 80mm (Aluminium)**

Clock Case - Corner Spandrel

- A = 60mm
- B = 80mm
- Pressed aluminium
- Brass colour
- Made in China

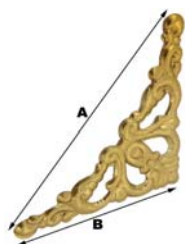

Code	Description	UOM	Price
C47655	60 x 80mm Corner Spandrel	EACH	£0.95

**Spandrel, Corner 61 x 83mm (Brass) E.U Made**

Clock Case - Corner Spandrel

- A = 61mm
- B = 83mm
- Brass Spandrel
- Pressed brass
- with Fixing Holes
- Made in E.U

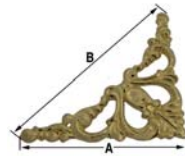

Code	Description	UOM	Price
E5116	61 x 83mm Corner Spandrel	EACH	£3.70

**Spandrel, Corner 70 x 95mm (Brass) E.U Made**

Clock Case - Corner Spandrel

- A = 70mm
- B = 95mm
- Brass Spandrel
- Pressed brass
- with Fixing Holes
- Made in E.U

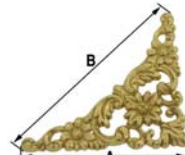

Code	Description	UOM	Price
E5117	70 x 95mm Corner Spandrel	EACH	£4.95

**Spandrel, Corner 80 x 110mm (Aluminium)**

Clock Case - Corner Spandrel

- A = 80mm
- B = 100mm
- Pressed aluminium
- Stainless steel colour
- Made in China

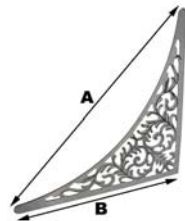

Code	Description	UOM	Price
C47657	80 x 110mm Corner Spandrel	EACH	£0.95

**Spandrel, Corner 80 x 110mm (Plastic)**

Clock Case - Corner Spandrel

- A = 80mm
- B = 100mm
- Plastic
- Brass colour
- Made in China

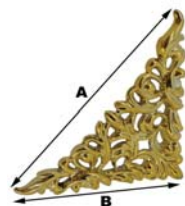

Code	Description	UOM	Price
C47658	80 x 10mm Corner Spandrel	EACH	£0.95

**Spandrel, Corner 80 x 112mm (Brass)**

Clock Case - Corner Spandrel

- A = 80mm
- B = 112mm
- Brass Spandrel
- with Fixing Holes

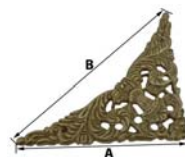

Code	Description	UOM	Price
E39707	80 x 112mm Corner Spandrel	EACH	£2.75

**Spandrel, Corner 80 x 112mm (Brass) E.U Made**

Clock Case - Corner Spandrel

- A = 80mm
- B = 112mm
- Brass Spandrel
- Pressed brass
- with Fixing Holes
- Made in E.U

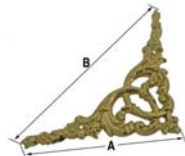

Code	Description	UOM	Price
E5118	80 x 112mm Corner Spandrel	EACH	£5.20

**Spandrel, Corner 90 x 120mm (Aluminium)**

Clock Case - Corner Spandrel

- A = 90mm
- B = 120mm
- Pressed aluminium
- Brass colour
- Made in China

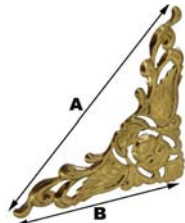

Code	Description	UOM	Price
C47656	90 x 125mm Corner Spandrel	EACH	£0.95

**Spandrel, Corner 90 x 120mm (Aluminium)**

Clock Case - Corner Spandrel

- A = 90mm
- B = 120mm
- Pressed aluminium
- Brass colour
- Made in China



Code	Description	UOM	Price
C47651	90 x 120mm Corner Spandrel	EACH	£0.95

**Spandrel, Corner 90 x 125mm (Brass)**

Clock Case - Corner Spandrel

- A = 90mm
- B = 125mm
- Brass Spandrel
- Pressed brass/zinc alloy
- Brass colour
- Made in China



Code	Description	UOM	Price
C47653	90 x 125mm Corner Spandrel	EACH	£2.95

**Spandrel, Corner 90 x 125mm (Brass) E.U Made**

Clock Case - Corner Spandrel

- A = 90mm
- B = 125mm
- Brass Spandrel
- Pressed brass
- with Fixing Holes
- Made in E.U

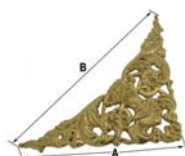

Code	Description	UOM	Price
E5111	90 x 125mm Corner Spandrel	EACH	£5.75

## DOMES (CLOCK)

### Spandrel, Corner 100 x 135mm (Brass)

Clock Case - Corner Spandrel

- A = 100mm
- B = 135mm
- Brass Spandrel
- Pressed brass/zinc alloy
- Brass colour
- Made in China



Code	Description	UOM	Price
C47654	100 x 135mm Corner Spandrel	EACH	£2.95

### Spandrel, Corner 100 x 140mm (Aluminium)

Clock Case - Corner Spandrel

- A = 100mm
- B = 140mm
- Pressed aluminium
- Brass colour
- Made in China



Code	Description	UOM	Price
C47652	100 x 140mm Corner Spandrel	EACH	£2.40

## DOMES (CLOCK)

### Acrylic Clock Dome



Clock Domes - Acrylic

These versatile domes find many uses as well as traditional clock dome like for example covers for ornaments and other decorative displays etc.

- High Quality
- Domes for 400 day Anniversary and skeleton clocks etc
- Made from tough clear Acrylic
- Plastic Ø1.80mm thick

Dimensions: Outside Diameter x Height

Code	Description	UOM	Price
D8988	Ø79mm x 133mm Dome	EACH	£23.95
D8989	Ø100mm x 142mm Dome	EACH	£24.50
D0429	Ø106mm x 182mm Dome	EACH	£24.95
D0430	Ø118mm x 200mm Dome	EACH	£26.95
D8996	Ø142mm x 260mm Dome	EACH	£28.95

## GLASSES (CLOCK)

### ACRYLIC (PLASTIC), CONVEX, STERNKREUZ MP

### Acrylic (Plastic), Convex, Sternkreuz MP

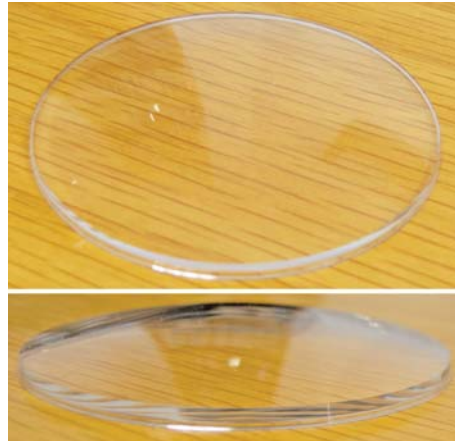

Clock Glasses - Acrylic (Plastic) Sternkreuz MP

High quality replacement domed clock glasses in acrylic plastic, superbly formed by Sternkreuz, made in Germany.

Sternkreuz "MP" Range: Ø50.5mm to Ø187.5mm

Dimension given is the overall diameter

- Ø50.5 to Ø80.0mm - In 0.5mm jumps e.g.: 50.5, 51.0, 51.5
- Ø81.0 to Ø120.0mm - In 1.0mm jumps eg: 81.0, 82.0, 83.0
- Ø127.5 to Ø187.5mm - In 10mm jumps eg: 127.5, 137.5, 147.5

Thickness

- Diameter Ø50.5 to Ø59.5 approximate thickness 1.6mm (+/- 0.1)
- Diameter Ø60.0 to Ø68.5 approximate thickness 1.7mm (+/- 0.1)
- Diameter Ø69.0 to Ø76.5 as well as to 127.5 – 137.5 – 157.5 – 177.5 and 187.5 approximate thickness 1.8mm (+/- 0.1)
- Diameter Ø77.0 to Ø120.0 approximate thickness 1.9mm (+/- 0.1)

Code	Description	UOM	Price
MP505	MP Sternkreuz 50.5	EACH	£3.50
MP510	MP Sternkreuz 51.0	EACH	£3.50
MP515	MP Sternkreuz 51.5	EACH	£3.50
MP520	MP Sternkreuz 52.0	EACH	£3.50
MP525	MP Sternkreuz 52.5	EACH	£3.50
MP530	MP Sternkreuz 53.0	EACH	£3.50
MP535	MP Sternkreuz 53.5	EACH	£3.50
MP540	MP Sternkreuz 54.0	EACH	£3.50
MP545	MP Sternkreuz 54.5	EACH	£3.50
MP550	MP Sternkreuz 55.0	EACH	£3.50
MP555	MP Sternkreuz 55.5	EACH	£3.50
MP560	MP Sternkreuz 56.0	EACH	£3.50
MP565	MP Sternkreuz 56.5	EACH	£3.50
MP570	MP Sternkreuz 57.0	EACH	£3.50
MP575	MP Sternkreuz 57.5	EACH	£3.50
MP580	MP Sternkreuz 58.0	EACH	£3.50
MP585	MP Sternkreuz 58.5	EACH	£3.50
MP590	MP Sternkreuz 59.0	EACH	£3.50
MP595	MP Sternkreuz 59.5	EACH	£3.50
MP600	MP Sternkreuz 60.0	EACH	£3.50
MP605	MP Sternkreuz 60.5	EACH	£3.50
MP610	MP Sternkreuz 61.0	EACH	£3.50

MP615	MP Sternkreuz 61.5	EACH	£3.50
MP620	MP Sternkreuz 62.0	EACH	£3.50
MP625	MP Sternkreuz 62.5	EACH	£3.50
MP630	MP Sternkreuz 63.0	EACH	£3.50
MP635	MP Sternkreuz 63.5	EACH	£3.50
MP640	MP Sternkreuz 64.0	EACH	£3.50
MP645	MP Sternkreuz 64.5	EACH	£3.50
MP650	MP Sternkreuz 65.0	EACH	£3.50
MP655	MP Sternkreuz 65.5	EACH	£3.50
MP660	MP Sternkreuz 66.0	EACH	£3.50
MP665	MP Sternkreuz 66.5	EACH	£3.50
MP670	MP Sternkreuz 67.0	EACH	£3.50
MP675	MP Sternkreuz 67.5	EACH	£3.50
MP680	MP Sternkreuz 68.0	EACH	£3.50
MP685	MP Sternkreuz 68.5	EACH	£3.50
MP690	MP Sternkreuz 69.0	EACH	£3.50
MP695	MP Sternkreuz 69.5	EACH	£3.50
MP700	MP Sternkreuz 70.0	EACH	£3.50
MP705	MP Sternkreuz 70.5	EACH	£3.50
MP710	MP Sternkreuz 71.0	EACH	£3.50
MP715	MP Sternkreuz 71.5	EACH	£3.50
MP720	MP Sternkreuz 72.0	EACH	£3.50
MP725	MP Sternkreuz 72.5	EACH	£3.50
MP730	MP Sternkreuz 73.0	EACH	£3.50
MP735	MP Sternkreuz 73.5	EACH	£3.50
MP740	MP Sternkreuz 74.0	EACH	£3.50
MP745	MP Sternkreuz 74.5	EACH	£3.50
MP750	MP Sternkreuz 75.0	EACH	£3.50
MP755	MP Sternkreuz 75.5	EACH	£3.50
MP760	MP Sternkreuz 76.0	EACH	£3.50
MP765	MP Sternkreuz 76.5	EACH	£3.50
MP770	MP Sternkreuz 77.0	EACH	£3.50
MP775	MP Sternkreuz 77.5	EACH	£3.50
MP780	MP Sternkreuz 78.0	EACH	£3.50
MP785	MP Sternkreuz 78.5	EACH	£3.50
MP790	MP Sternkreuz 79.0	EACH	£3.50
MP795	MP Sternkreuz 79.5	EACH	£3.50
MP800	MP Sternkreuz 80.0	EACH	£3.50
MP810	MP Sternkreuz 81.0	EACH	£3.50
MP820	MP Sternkreuz 82.0	EACH	£3.50
MP830	MP Sternkreuz 83.0	EACH	£3.50
MP840	MP Sternkreuz 84.0	EACH	£3.50
MP850	MP Sternkreuz 85.0	EACH	£3.50
MP860	MP Sternkreuz 86.0	EACH	£3.50
MP870	MP Sternkreuz 87.0	EACH	£3.50
MP880	MP Sternkreuz 88.0	EACH	£3.50
MP890	MP Sternkreuz 89.0	EACH	£3.50
MP900	MP Sternkreuz 90.0	EACH	£3.50
MP910	MP Sternkreuz 91.0	EACH	£3.50
MP920	MP Sternkreuz 92.0	EACH	£3.50
MP930	MP Sternkreuz 93.0	EACH	£3.50
MP940	MP Sternkreuz 94.0	EACH	£3.50
MP950	MP Sternkreuz 95.0	EACH	£3.50
MP960	MP Sternkreuz 96.0	EACH	£3.50
MP970	MP Sternkreuz 97.0	EACH	£3.50
MP980	MP Sternkreuz 98.0	EACH	£3.50
MP990	MP Sternkreuz 99.0	EACH	£3.50
MP1000	MP Sternkreuz 100.0	EACH	£3.50
MP1010	MP Sternkreuz 101.0	EACH	£3.50
MP1020	MP Sternkreuz 102.0	EACH	£3.50
MP1030	MP Sternkreuz 103.0	EACH	£3.50
MP1040	MP Sternkreuz 104.0	EACH	£3.50
MP1050	MP Sternkreuz 105.0	EACH	£3.50
MP1060	MP Sternkreuz 106.0	EACH	£3.50
MP1070	MP Sternkreuz 107.0	EACH	£3.50
MP1080	MP Sternkreuz 108.0	EACH	£3.50
MP1090	MP Sternkreuz 109.0	EACH	£3.50
MP1100	MP Sternkreuz 110.0	EACH	£3.50
MP1110	MP Sternkreuz 111.0	EACH	£3.50
MP1120	MP Sternkreuz 112.0	EACH	£3.50
MP1130	MP Sternkreuz 113.0	EACH	£3.50
MP1140	MP Sternkreuz 114.0	EACH	£3.50
MP1150	MP Sternkreuz 115.0	EACH	£3.50
MP1160	MP Sternkreuz 116.0	EACH	£3.50
MP1170	MP Sternkreuz 117.0	EACH	£3.50



Online Discounts



SAME DAY DISPATCH

MP1180	MP Sternkreuz 118.0	EACH	£3.50
MP1190	MP Sternkreuz 119.0	EACH	£3.50
MP1200	MP Sternkreuz 120.0	EACH	£3.50
MP1275	MP Sternkreuz 127.5	EACH	£4.50
MP1375	MP Sternkreuz 137.5	EACH	£4.50
MP1575	MP Sternkreuz 157.5	EACH	£4.50
MP1675	MP Sternkreuz 167.5	EACH	£4.50
MP1775	MP Sternkreuz 177.5	EACH	£4.50
MP1875	MP Sternkreuz 187.5	EACH	£4.50

## MINERAL GLASS (ROUGH EDGE) CONVEX CLOCK GLASSES



Convex clock glasses are in traditional imperial sizing and a 1/16th plus or minus allowance must be allowed when ordering.

Doming Heights:

- For all non sternkreuz (MMG) convex glasses allowances must be made as due to the manufacture process, doming is inconsistent

MMG Interior Doming Heights:

- Up to Ø60mm = Doming height 5 - 6mm
- Up to Ø70mm = Doming height 6 - 7mm
- Up to Ø90mm = Doming height 7 - 8mm
- Up to Ø100mm = Doming height 8 - 9mm
- Up to Ø120mm = Doming height 8.5 - 10mm
- Up to Ø140mm = Doming height 10 - 11mm
- Up to Ø160mm = Doming height 11 - 12mm
- Up to Ø170mm = Doming height 12 - 13mm
- Up to Ø180mm = Doming height 13 - 14mm
- Up to Ø190mm = Doming height 13 - 15mm
- Up to Ø200mm = Doming height 15 - 16mm
- Up to Ø210mm = Doming height 16 - 17mm
- Up to Ø220mm = Doming height 18 - 19mm
- Up to Ø240mm = Doming height 19 - 20mm
- Up to Ø260mm = Doming height 20 - 21mm
- Up to Ø300mm = Doming height 22 - 23mm
- Up to Ø330mm = Doming height 24 - 25mm

### From 2" Rough Edge Glasses



Rough Edge - From 2" (51mm)

Convex clock glasses are in traditional Imperial Sizing and a 1/16th plus or minus allowance must be allowed when ordering, as manufacture/doming is inconsistent.

Dimension given is the overall diameter

- MMG glasses have an approximate thickness of 2.0 mm + - 0.2 mm

Code	Description	UOM	Price
C7068	2" (51mm) Convex Glass	EACH	£4.95
C7068A	2 1/16" (52mm) Convex Glass	EACH	£4.95
C7068B	2 2/16" (54mm) Convex Glass	EACH	£4.95
C7068C	2 3/16" (56mm) Convex Glass	EACH	£4.95
C7068D	2 4/16" (57mm) Convex Glass	EACH	£4.95
C7068E	2 5/16" (59mm) Convex Glass	EACH	£4.95
MMG60	60mm Sternkreuz MMG	EACH	£4.95
C7068G	2 7/16" (62mm) Convex Glass	EACH	£4.95
C7068H	2 8/16" (63mm) Convex Glass	EACH	£4.95
C7068I	2 9/16" (65mm) Convex Glass	EACH	£4.95
C7068J	2 10/16" (67mm) Convex Glass	EACH	£4.95
C7068K	2 11/16" (68mm) Convex Glass	EACH	£4.95
C7068L	2 12/16" (70mm) Convex Glass	EACH	£4.95
C7068M	2 13/16" (71mm) Convex Glass	EACH	£4.95
C7068N	2 14/16" (73mm) Convex Glass	EACH	£4.95
MMG75	75mm Sternkreuz MMG	EACH	£4.95
Price breaks available, see website			

### From 3" Rough Edge Glasses



Rough Edge - From 3" (76mm)

Convex clock glasses are in traditional Imperial Sizing and a 1/16th plus or minus allowance must be allowed when ordering, as manufacture/doming is inconsistent.

Dimension given is the overall diameter

- MMG glasses have an approximate thickness of 2.0 mm + - 0.2 mm

Code	Description	UOM	Price
MMG76	76mm Sternkreuz MMG	EACH	£4.95
MMG78	78mm Sternkreuz MMG	EACH	£4.95
C7069B	3 2/16" (79mm) Convex Glass	EACH	£4.95
C7069C	3 3/16" (81mm) Convex Glass	EACH	£4.95
C7069D	3 4/16" (83mm) Convex Glass	EACH	£4.95
MMG84	84mm Sternkreuz MMG	EACH	£4.95
MMG86	86mm Sternkreuz MMG	EACH	£4.95
MMG87	87mm Sternkreuz MMG	EACH	£4.95
MMG89	89mm Sternkreuz MMG	EACH	£4.95
MMG92	92mm Sternkreuz MMG	EACH	£4.95
C7069K	3 11/16" (94mm) Convex Glass	EACH	£4.95
MMG95	95mm Sternkreuz MMG	EACH	£4.95
C7069M	3 13/16" (97mm) Convex Glass	EACH	£4.95
MMG98	98mm Sternkreuz MMG	EACH	£4.95
C7069O	3 15/16" (100mm) Convex Glass	EACH	£4.95
Price breaks available, see website			

### From 4" Rough Edge Glasses



Rough Edge - From 4" (102mm)

Convex clock glasses are in traditional Imperial Sizing and a 1/16th plus or minus allowance must be allowed when ordering, as manufacture/doming is inconsistent.

Dimension given is the overall diameter

- MMG glasses have an approximate thickness of 2.0 mm + - 0.2 mm

Code	Description	UOM	Price
MMG102	102mm Sternkreuz MMG	EACH	£5.95
C7070B	4 2/16" (105mm) Convex Glass	EACH	£4.95
C7070D	4 4/16" (108mm) Convex Glass	EACH	£4.95
MMG110	110mm Sternkreuz MMG	EACH	£5.95

MMG111	111mm Sternkreuz MMG	EACH	£5.95
MMG113	113mm Sternkreuz MMG	EACH	£5.95
MMG116	116mm Sternkreuz MMG	EACH	£5.95
MMG119	119mm Sternkreuz MMG	EACH	£5.95
MMG122	122mm Sternkreuz MMG	EACH	£6.25
C7070N	4 14/16" (124mm) Convex Glass	EACH	£4.95
C7070O	4 15/16" (125mm) Convex Glass	EACH	£4.95
C7070C	4 3/16" (106mm) Convex Glass	EACH	£4.95
Price breaks available, see website			

### From 5" Rough Edge Glasses



Rough Edge - From 5" (127mm)

Convex clock glasses are in traditional Imperial Sizing and a 1/16th plus or minus allowance must be allowed when ordering, as manufacture/doming is inconsistent.

Dimension given is the overall diameter

- MMG glasses have an approximate thickness of 2.0 mm + - 0.2 mm

Code	Description	UOM	Price
C7071A	5 1/16" (129mm) Convex Glass	EACH	£4.95
MMG130	130mm Sternkreuz MMG	EACH	£6.25
C7071C	5 3/16" (132mm) Convex Glass	EACH	£4.95
C7071D	5 4/16" (133mm) Convex Glass	EACH	£4.95
C7071E	5 5/16" (135mm) Convex Glass	EACH	£4.95
C7071F	5 6/16" (136mm) Convex Glass	EACH	£4.95
C7071G	5 7/16" (138mm) Convex Glass	EACH	£4.95
C7071H	5 8/16" (140mm) Convex Glass	EACH	£4.95
C7071I	5 9/16" (141mm) Convex Glass	EACH	£4.95
C7071J	5 10/16" (143mm) Convex Glass	EACH	£4.95
MMG144	Glass Convex MMG Sternkreuz (144mm)	EACH	£6.25
MMG146	Glass Convex MMG Sternkreuz (146mm)	EACH	£6.25
MMG148	148mm Sternkreuz MMG	EACH	£6.25
MMG150	150mm Sternkreuz MMG	EACH	£6.25
Price breaks available, see website			

### From 6" Rough Edge Glasses



Rough Edge - From 6" (152mm)

Convex clock glasses are in traditional Imperial Sizing and a 1/16th plus or minus allowance must be allowed when ordering, as manufacture/doming is inconsistent.

Dimension given is the overall diameter

- MMG glasses have an approximate thickness of 2.0 mm + - 0.2 mm

Code	Description	UOM	Price
MMG152	152mm Sternkreuz MMG	EACH	£6.25
MMG154	154mm Sternkreuz MMG	EACH	£6.25
MMG156	156mm Sternkreuz MMG	EACH	£6.25
C7072D	6 4/16" (159mm) Convex Glass	EACH	£4.95
C7072E	6 5/16" (160mm) Convex Glass	EACH	£4.95
C7072F	6 6/16" (162mm) Convex Glass	EACH	£4.95
C7072G	6 7/16" (163mm) Convex Glass	EACH	£4.95
C7072H	6 8/16" (165mm) Convex Glass	EACH	£4.95
C7072I	6 9/16" (167mm) Convex Glass	EACH	£4.95
C7072J	6 10/16" (168mm) Convex Glass	EACH	£4.95
C7072K	6 11/16" (170mm) Convex Glass	EACH	£4.95
MMG170	170mm Sternkreuz MMG	EACH	£8.95
MMG172	172mm Sternkreuz MMG	EACH	£9.95
MMG174	174mm Sternkreuz MMG	EACH	£9.95
MMG176	176mm Sternkreuz MMG	EACH	£9.95
Price breaks available, see website			

**From 7" Rough Edge Glasses**



Rough Edge - From 7" (178mm)

Convex clock glasses are in traditional Imperial Sizing and a 1/16th plus or minus allowance must be allowed when ordering, as manufacture/doming is inconsistent.

Dimension given is the overall diameter

- MMG glasses have an approximate thickness of 2.0 mm + - 0.2 mm

Code	Description	UOM	Price
MMG178	178mm Sternkreuz MMG	EACH	£9.95
C7073C	7 3/16" (182mm) Convex Glass	EACH	£4.95
MMG184	184mm Sternkreuz MMG	EACH	£9.95
MMG186	186mm Sternkreuz MMG	EACH	£9.95
MMG198	198mm Sternkreuz MMG	EACH	£10.25
MMG200	200mm Sternkreuz MMG	EACH	£10.25
Price breaks available, see website			

**From 8" Rough Edge Glasses**



Rough Edge - From 8" (205mm)

Convex clock glasses are in traditional Imperial Sizing and a 1/16th plus or minus allowance must be allowed when ordering, as manufacture/doming is inconsistent.

Dimension given is the overall diameter

- MMG glasses have an approximate thickness of 2.0 mm + - 0.2 mm

Code	Description	UOM	Price
MMG205	205mm Sternkreuz MMG	EACH	£15.25
MMG210	210mm Sternkreuz MMG	EACH	£15.95
MMG220	220mm Sternkreuz MMG	EACH	£15.95
C7074M	8 13/16" (224mm) Convex Glass	EACH	£10.95
MMG225	225mm Sternkreuz MMG	EACH	£15.95
Price breaks available, see website			

**From 9" Rough Edge Glasses**



Rough Edge - From 9" (228mm)

Convex clock glasses are in traditional Imperial Sizing and a 1/16th plus or minus allowance must be allowed when ordering, as manufacture/doming is inconsistent.

Dimension given is the overall diameter

- MMG glasses have an approximate thickness of 2.0 mm + - 0.2 mm

Code	Description	UOM	Price
C7075B	9 2/16" (232mm) Convex Glass	EACH	£11.95
C7075C	9 3/16" (233mm) Convex Glass	EACH	£11.95
C7075D	9 4/16" (235mm) Convex Glass	EACH	£11.95
C7075E	9 5/16" (236mm) Convex Glass	EACH	£11.95
C7075F	9 6/16" (238mm) Convex Glass	EACH	£11.95
C7075G	9 7/16" (240mm) Convex Glass	EACH	£11.95
C7075H	9 8/16" (241mm) Convex Glass	EACH	£11.95
C7075I	9 9/16" (243mm) Convex Glass	EACH	£11.95
MMG245	245mm Sternkreuz MMG	EACH	£15.95
MMG250	250mm Sternkreuz MMG	EACH	£15.95
Price breaks available, see website			

**From 10" Rough Edge Glasses**



Rough Edge - From 10" (255mm)

Convex clock glasses are in traditional Imperial Sizing and a 1/16th plus or minus allowance must be allowed when ordering, as manufacture/doming is inconsistent.

Dimension given is the overall diameter

- MMG glasses have an approximate thickness of 2.0 mm + - 0.2 mm

Code	Description	UOM	Price
MMG255	255mm Sternkreuz MMG	EACH	£19.95
MMG260	260mm Sternkreuz MMG	EACH	£19.95
MMG265	265mm Sternkreuz MMG	EACH	£19.95
C7076H	10 8/16" (267mm) Convex Glass	EACH	£14.95
MMG270	270mm Sternkreuz MMG	EACH	£19.95
C7076L	10 12/16" (273mm) Convex Glass	EACH	£14.95
C7076O	10 15/16" (278mm) Convex Glass	EACH	£14.95
Price breaks available, see website			

**From 11" Rough Edge Glasses**



Rough Edge - From 11" (279mm)

Convex clock glasses are in traditional Imperial Sizing and a 1/16th plus or minus allowance must be allowed when ordering, as manufacture/doming is inconsistent.

Dimension given is the overall overall diameter

- MMG glasses have an approximate thickness of 2.0 mm + - 0.2 mm

Code	Description	UOM	Price
C7077A	11 1/16" (281mm) Convex Glass	EACH	£16.75
C7077D	11 4/16" (286mm) Convex Glass	EACH	£16.75
C7077E	11 5/16" (287mm) Convex Glass	EACH	£16.75
MMG295	295mm Sternkreuz MMG	EACH	£19.95
MMG300	300mm Sternkreuz MMG	EACH	£19.95
Price breaks available, see website			

**From 12" Rough Edge Glasses**



Rough Edge - From 12" (304.5mm)

Convex clock glasses are in traditional Imperial Sizing and a 1/16th plus or minus allowance must be allowed when ordering, as manufacture/doming is inconsistent.

Dimension given is the overall diameter

- MMG glasses have an approximate thickness of 2.0 mm + - 0.2 mm

Code	Description	UOM	Price
C7078	12" (304.5mm) Convex Glass	EACH	£14.95
MMG305	305mm Sternkreuz MMG	EACH	£19.95
Price breaks available, see website			

**TODAY** SAME DAY DISPATCH



**From 13" Rough Edge Glasses**



Rough Edge - From 13" (330mm)

Convex clock glasses are in traditional Imperial Sizing and a 1/16th plus or minus allowance must be allowed when ordering, as manufacture/doming is inconsistent.

Dimension given is the overall diameter

- MMG glasses have an approximate thickness of 2.0 mm + - 0.2 mm

Code	Description	UOM	Price
MMG330	330mm Sternkreuz MMG	EACH	£21.95
C7079N	13 14/16" (353mm) Convex Glass	EACH	£33.95
Price breaks available, see website			

**From 14" Rough Edge Glasses**



Rough Edge - From 14" (355mm)

Convex clock glasses are in traditional Imperial Sizing and a 1/16th plus or minus allowance must be allowed when ordering, as manufacture/doming is inconsistent.

Dimension given is the overall diameter

Code	Description	UOM	Price
C7080	14" (355mm) Convex Glass	EACH	£22.95
Price breaks available, see website			

**GONGS**

**GONG RODS**

**Rods, Bronze Individual**



Individual Bronze Gong Rods

- Length includes the screw
- Bronze Rods are Ø2.80mm
- Thread size is industry standard 6.5mm with a slight taper for vital tight fit to your block
- Ø6.50mm tap available under our code T48748 & T48747
- Made in Germany

Dimension is the overall rod length (including the screw).

Code	Description	UOM	Price
G8884	240mm Bronze Gong Rod	EACH	£5.65
G8885	310mm Bronze Gong Rod	EACH	£5.65
G8886	350mm Bronze Gong Rod	EACH	£5.65

**Tap for Gong Rods**

See Page: 1031

**Rods, Bronze Sets**



Individual Bronze Gong Rods - Sets (without mounting bracket)

- Tuned Pack of 4 and 5
- Length includes the screw
- Bronze Rods are Ø2.80mm
- Westminster
- Thread size is industry standard 6.5mm with a slight taper for vital tight fit to your block
- Ø6.50mm tap available under our code T48748 & T48747
- Made in Germany

Dimension is the longest rod (including the screw) in the tuned pack.

Code	Description	UOM	Price
G8878	245mm (4 Pack) Bronze	PACK*4	£13.95
G8880	245mm (5 Pack) Bronze	PACK*5	£15.25
G8879	290mm (4 Pack) Bronze	PACK*4	£14.95
G8881	295mm (5 Pack) Bronze	PACK*5	£15.70

**Rods, Bronze Pairs**



Individual Bronze Gong Rods - Pairs (without mounting bracket)

- Pack of 2
- Length includes the screw
- Bronze Rods are Ø2.80mm
- Thread size is industry standard 6.5mm with a slight taper for vital tight fit to your block
- Ø6.50mm tap available under our code T48748 & T48747
- Overall lengths 195mm & 205mm

Dimension is the overall rod length (including the screw).

Code	Description	UOM	Price
G32037	205 & 195mm Gong Rods	PAIR	£1.95

**Rods, Steel Individual**



Individual Steel Gong Rods

- Length includes the screw
- Steel Rods are Ø3.60mm
- Thread size is industry standard 6.5mm with a slight taper for vital tight fit to your block
- Ø6.50mm tap available under our code T48748 & T48747
- Made in Germany

Dimension is the overall rod length (including the screw).

Code	Description	UOM	Price
G8887	360mm Steel Gong Rod	EACH	£5.95
G8888	483mm Steel Gong Rod	EACH	£5.95
G8889	535mm Steel Gong Rod	EACH	£5.95
G8890	670mm Steel Gong Rod	EACH	£5.95

**Rods, Steel Sets**



Individual Steel Gong Rods - Sets (without mounting bracket)

- Tuned Pack of 8
- Length includes the screw
- Steel Rods are Ø3.60mm
- Westminster
- Thread size is industry standard 6.5mm with a slight taper for vital tight fit to your block
- Ø6.50mm tap available under our code T48748 & T48747
- Made in Germany

Dimension is the longest rod (including the screw) in the tuned pack.

Code	Description	UOM	Price
G8882	500mm (8 Pack) Steel	PACK*8	£32.75
G8883	670mm (8 Pack) Steel	PACK*8	£32.85

**GONGS (HAMMERBACK)**

**Bim Bam Gongs, Style 1**

Bim Bam Chime Gongs

- Bim Bam
- Hammerback gongs
- Cast base 80 x 80mm
- Bronze rods
- See website "more info" for specifications
- Made in Germany or Hermle Germany

Dimensions

- Rod amount, longest rod

G46237 used with Hermle calibres:

- Hermle 141.030

**3 Rod, 19.5cm Gong, Hermle**

- Longest rod 19.5cm
- 3 bronze rods



Code	Description	UOM	Price
G46237	3 Rod, 19.5cm Gong, Hermle	EACH	£13.95

**3 Rod, 35cm Gong, Germany**

- Longest rod 35cm
- 3 bronze rods
- Gong for longcase movement



Code	Description	UOM	Price
G34446	3 Rod, 35cm Gong, Germany	EACH	£42.40

**Bim Bam Gongs, Style 2**

Bim Bam Chime Gongs

- Bim Bam
- Hammerback gongs
- Steel rods
- See website "more info" for specifications
- Made in China

Dimensions

- Rod amount, longest rod



Code	Description	UOM	Price
G48064	2 Rod, 39cm Gong	EACH	£3.95
G48065	3 Rod, 50cm Gong	EACH	£7.95

**Bim Bam Gongs, Style 3**

Bim Bam Chime Gongs

- Bim Bam
- Hammerback gongs
- Steel rods
- See website "more info" for specifications
- Hermle Germany

Dimensions

- Rod amount, longest rod

G46239 used with Hermle calibres:

- Hermle 141.050

G46241 used with Hermle calibres:

- Hermle 241.050

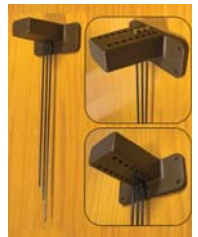

Code	Description	UOM	Price
G46239	3 Rod, 35cm Gong, Hermle	EACH	£19.95
G46241	3 Rod, 50cm Gong, Hermle	EACH	£16.95

**Westminster Chime Gongs, Style 1**

Westminster Chime Gongs

- Westminster
- Hammerback gongs
- Cast base 90 x 100mm
- Bronze or steel rods
- See website "more info" for specifications
- Hermle Germany or unbranded

Dimensions

- Rod amount, longest rod

H28887 used with Hermle calibres:

- Hermle 351.050
- Hermle 351.850



Code	Description	UOM	Price
H28887	8 Rod, 34cm Gong, Hermle	EACH	£19.95
G7856	8 Rod, 50cm Gong, Hermle	EACH	£29.95
G46065	8 Rod, 57cm Gong	EACH	£24.95



**Westminster Chime Gongs, Style 2**

Westminster Chime Gongs

- Westminster
- Hammerback gongs
- Cast base 90 x 100mm
- Steel rods
- See website "more info" for specifications
- Made in Germany

Dimensions  
• Rod amount, longest rod



Code	Description	UOM	Price
G7855	8 Rod, 68cm Gong, Germany	EACH	£54.85

**Westminster Chime Gongs, Style 3**

Westminster Chime Gongs

- Westminster
- Hammerback gongs
- Cast base 115 x 50mm
- Steel rods
- See website "more info" for specifications
- Hermle Germany

Dimensions  
• Rod amount, longest rod



G46248 used with Hermle calibres:  
• Hermle 451.053H

G46249 used with Hermle calibres:  
• Hermle 461.053H  
• Hermle 461.853H  
• Hermle 471.050

Code	Description	UOM	Price
G46248	8 Rod, 50cm Gong, Hermle	EACH	£31.95
G46249	8 Rod, 68cm Gong, Hermle	EACH	£31.95

**Westminster Chime Gongs, Style 4**

Westminster Gongs

- Westminster chime
- Hammerback gongs
- Cast base 80 x 35mm
- Bronze rods
- "Ascending" = longest rod nearest the base
- "Descending" = Shortest rod nearest the base
- See website "more info" for specifications
- Hermle Germany

Dimensions  
• Rod amount, longest rod



G46243 used with Hermle calibres:  
• Hermle 351.020

H28885 used with Hermle calibres:  
• Hermle 341.020

Code	Description	UOM	Price
G46243	5 Rod (Ascending), 20cm Gong, Hermle	EACH	£14.95
H28885	5 Rod (Descending), 20cm Gong, Hermle	EACH	£18.95

**Westminster Chime Gongs, Style 5**

Westminster Chime Gongs

- Westminster
- Hammerback gongs
- Cast base 80 x 35mm
- Steel rods
- See website "more info" for specifications
- Hermle Germany

Dimensions  
• Rod amount, longest rod



G46244 used with Hermle calibres:  
• Hermle 351.030  
• Hermle 351.830  
• Hermle 451.030

Code	Description	UOM	Price
G46244	5 Rod, 37cm Gong, Hermle	EACH	£16.95

**Triple Chime Gongs, Style 1**

Triple Chime Gongs

- Triple chime gongs (Westminster, Whittingdon & St Michael)
- Hammerback gongs
- Cast base 100 x 130mm
- Steel rods
- See website "more info" for specifications
- Hermle Germany

Dimensions  
• Rod amount, longest rod



H28888 used with Hermle calibres:  
• Hermle 1051.051  
• Hermle 1151.053H

G46244 used with Hermle calibres:  
• Hermle 1161.085H  
• Hermle 1161.853H  
• Hermle 1171.050  
• Hermle 1171.850

Code	Description	UOM	Price
H28888	12 Rod, 50cm Gong, Hermle	EACH	£39.95
G8868	12 Rod, 68cm Gong, Hermle	EACH	£44.95

**Triple Chime Gongs, Style 2**

Triple Chime Hermle Gongs

- Triple chime gongs (Westminster, Whittingdon & St Michael)
- Hammerback gongs
- Cast base 100 x 95mm
- Steel rods
- See website "more info" for specifications
- Made in China

Dimensions  
• Rod amount, longest rod



Code	Description	UOM	Price
G46066	8 Rod, 56cm Gong	EACH	£29.95

**Triple Chime Gongs, Style 3**

Triple Chime Gongs

- Triple chime gongs (Westminster, Whittingdon & St Michael)
- Hammerback gongs
- Cast base 80 x 35mm
- Steel rods
- See website "more info" for specifications
- Hermle Germany

Dimensions  
• Rod amount, longest rod

G46250 used with Hermle calibres:  
• Hermle 1051.030  
• Hermle 1151.030

Code	Description	UOM	Price
G46250	8 Rod, 35cm Gong, Hermle	EACH	£24.95

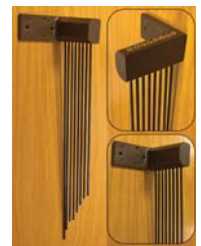

**Triple Chime Gongs, Style 4**

Triple Chime Gongs

- Triple chime gongs (Westminster, Whittingdon & St Michael)
- Hammerback gongs
- Cast base 90 x 100mm
- Steel rods
- See website "more info" for specifications
- Made in Germany

Dimensions  
• Rod amount, longest rod

Code	Description	UOM	Price
G34450	8 Rod, 68cm Gong	EACH	£49.95



**GONGS (SIDE HAMMER)**

**Bim Bam Gongs (Hermle)**

Bim Bam Gongs

- Bim Bam
- Side hammer gongs
- Cast base 90 x 50mm
- Bronze Rods
- Base has 5 rod holding holes, either gong rods are to one side or in the middle (see additional images)
- Rods are either flush to the base or are bushed (see additional images)
- See website "more info" for specifications
- Hermle Germany

Dimensions  
• Rod amount, longest rod

\*Rods are sunken at the rear, i.e flush to the cast base, for mounting purposes if required

G46253 used with Hermle calibres:  
• Hermle 131.030

G46242 used with Hermle calibres:  
• Hermle 261.030

G46240 used with Hermle calibres:  
• Hermle 241.030  
• Hermle 271.030



Tap for Gong Rods



See Page: 1031

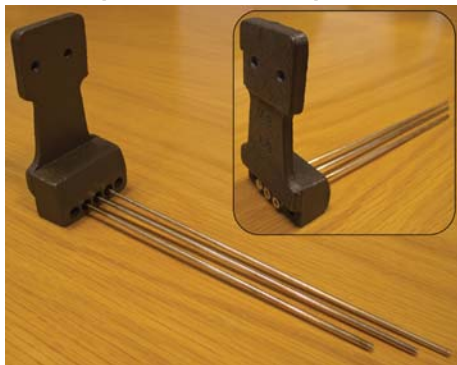

**3 Rods (From the Middle), 20cm**

- 3 bronze rods
- Longest rod 20cm
- Rods from the middle
- Bushed rod fittings

Code	Description	UOM	Price
G46253	3 Rods (From the Middle), 20cm	EACH	£11.95

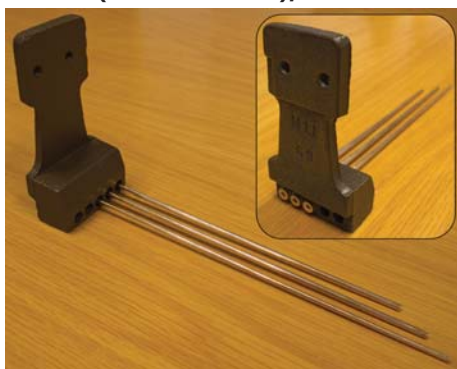
**3 Rods (From the Side), 20cm**

- 3 bronze rods
- Longest rod 20cm
- Rods from one side
- Bushed rod fittings

Code	Description	UOM	Price
G46242	3 Rods (From the Side), 20cm	EACH	£11.95

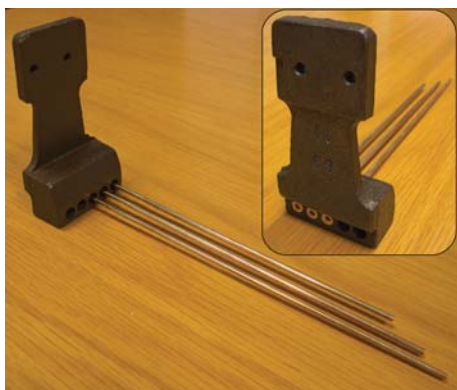
**3 Rods (From the Side, Flush\*), 20cm**

- 3 bronze rods
- Longest rod 20cm
- Rods from one side
- Flush rod fittings

Code	Description	UOM	Price
G46240	3 Rods (From the Side, Flush*), 20cm	EACH	£11.95

**PRICE PROMISE  
GUARANTEE** 

**GONGS (SPIRAL)****Spiral Gong Base**

Gongs - Base

- For spiral type wire gongs
- 2" diameter solid metal block
- Domed to Height 19mm with gong retaining screw
- 2 block locating eyes for securing to clock case



Code	Description	UOM	Price
G9730	Gong Base with Screw	EACH	£1.95

**Spiral with Cast Mounting**

Gongs - Spiral for Regulator Clocks

- Includes cast mounting bracket
- Diameters are approx.

Code	Description	UOM	Price
G7757	Ø14cm Gong Mounted	EACH	£29.90
G34449	Ø24cm Gong Mounted	EACH	£49.95

**Spiral with External Block**

Gongs - Spiral for Clocks

Economical manufacture for repro style wall clocks.

- With Brass Mounting
- Outer Ring External Fixing
- Diameters are approx.



Code	Description	UOM	Price
G5234	Ø75mm Spiral Gongs with External Block	EACH	£2.40

**Spiral with Internal Block**

Gongs - Spiral for Clocks

Economical manufacture for repro style wall clocks.

- With Brass Mounting
- Inner Ring Fixing
- Diameters are approx.

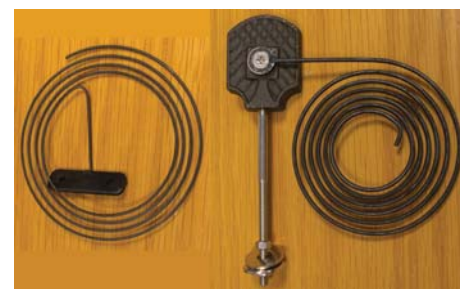

Code	Description	UOM	Price
G5233	Ø110mm Spiral Gongs with Internal Block	EACH	£2.25

**Spiral, Hermle**

Gongs - Spiral for Regulator Clocks

- Includes cast mounting bracket
- Diameters are approx.
- Hermle Germany

G46238 used with Hermle calibres:

- Hermle 141.040
- Hermle 141.041
- Hermle 241.040
- Hermle 241.840

G46236 used with Hermle calibres:

- Hermle 141.020

Code	Description	UOM	Price
G46238	Ø9cm Gong with Centre Mount	EACH	£4.50
G46236	Ø9cm Gong with Side Mount	EACH	£4.50

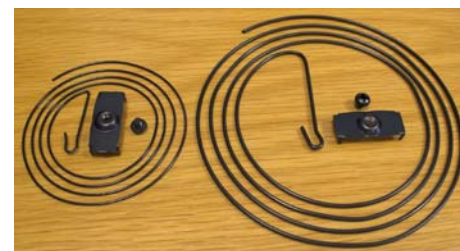
**Spiral for Cuckoo Clocks**

Cuckoo Clock Gongs

- Cuckoo clock gongs
- Spiral gongs
- With fittings
- Size given is the overall diameter
- Original Black Forest cuckoo clock parts
- Made in Germany

Code	Description	UOM	Price
G44281	Ø60mm Cuckoo Gong	EACH	£1.20
G44282	Ø70mm Cuckoo Gong	EACH	£1.30
G44283	Ø80mm Cuckoo Gong	EACH	£1.50
G44284	Ø90mm Cuckoo Gong	EACH	£1.70
G44285	Ø100mm Cuckoo Gong	EACH	£1.90
G44286	Ø120mm Cuckoo Gong	EACH	£2.25
G44287	Ø140mm Cuckoo Gong	EACH	£2.50

**GONGS (UNDERSLUNG)****Bim Bam Gongs, Style 1**

Bim Bam Chime Gongs

 **TRADE  
SUPPLIER**

- Bim Bam
- Underslung gongs
- Cast base, 100 x 40mm
- Bronze rods
- See website "more info" for specifications
- Made in Germany

Dimensions  
• Rod amount, longest rod

Code	Description	UOM	Price
G34447	3 Rod, 17.5cm Gong	EACH	£17.95

## Bim Bam Gongs, Style 2



Bim Bam Chime Gongs

- Bim Bam
- Underslung gongs
- Cast base, 55 x 35mm
- Bronze rods
- See website "more info" for specifications
- Hermle Germany

Dimensions  
• Rod amount, longest rod

Code	Description	UOM	Price
G47065	3 Rod, 19.5cm Gong, Hermle	EACH	£11.95

## Bim Bam Gongs, Style 3



Bim Bam Chime Gongs

- Bim Bam
- Underslung gongs
- Cast base, 100 x 60mm
- Bronze rods
- See website "more info" for specifications
- Made in Germany

Dimensions  
• Rod amount, longest rod

Code	Description	UOM	Price
G34448	4 Rod, 25cm Gong	EACH	£24.50

### Tap for Gong Rods

See Page: 1031



## Westminster Chime Gongs, Style 1



Westminster Chime Gongs

- Westminster chime
- Underslung gongs
- Cast base, 80 x 55mm
- Bronze rods
- See website "more info" for specifications
- Made in Germany

Dimensions  
• Rod amount, longest rod

Code	Description	UOM	Price
G7756	5 Rod, 25cm Gong	EACH	£37.95

## Westminster Chime Gongs, Style 2



Westminster Chime Gongs

- Westminster chime
- Underslung gongs
- Cast base, 100 x 60mm
- Bronze rods
- See additional images for technical drawings
- Hermle Germany

Dimensions  
• Rod amount, longest rod (rod height from base)

G46157 used with Hermle calibres:  
• Hermle 350.020

G7755 used with Hermle calibres:  
• Hermle 340.020

Code	Description	UOM	Price
G46157	5 Rod, 20cm (12mm High) Gong, Hermle	EACH	£17.95
G7755	5 Rod, 20cm (23mm High) Gong, Hermle	EACH	£15.95
H28886	5 Rod, 30cm (20mm High) Gong, Hermle	EACH	£18.95



Clock Gong/Rod Cutter, HIT

See Page 822



## Triple Chime Gongs, Style 1

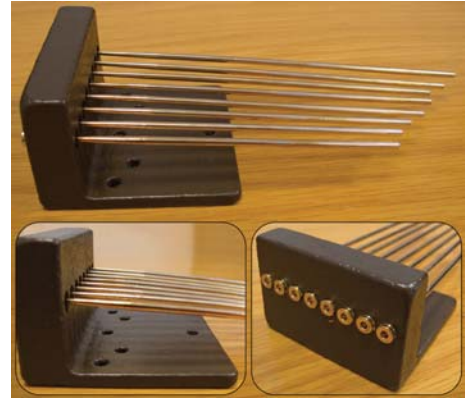

Triple Chime Gongs

- Triple chime (Westminster, Whittingdon & St Michael)
- Underslung gongs
- Cast base, 70 x 70mm
- Bronze Rods
- See website "more info" for specifications
- Hermle Germany

Dimensions  
• Rod amount, longest rod

G46246 used with Hermle calibres:

- Hermle 1050.020
- Hermle 1051.020

Code	Description	UOM	Price
G46247	8 Rod, 17cm Gong, Hermle	EACH	£33.95
G46246	8 Rod, 20cm Gong, Hermle	EACH	£33.95



## Longcase Hand Collets



Long Case Clock - Hand Collet

- Brass
- Turned hand collets
- Packs of 5 pieces per size
- Ø10mm, 11mm & 13mm
- Made in UK

Code	Description	UOM	Price
L0913	Ø10mm (3/8") Collets	PACK*5	£2.95
L0914	Ø11mm (7/16") Collets	PACK*5	£2.95
L0915	Ø13mm (1/2") Collets	PACK*5	£2.95

Clock Gong/Rod Cutter, Faithfull

See Page 822





**Mechanical Clock Hand Collets**



Mechanical Clocks - Minute & Hour Hand Collets

- Brass
- Various Sizes
- Square Minute
- Round Hour
- 60 pieces
- Made in Germany

Code	Description	UOM	Price
<b>H8942</b>	Minute & Hour Clock Hand Collets	PACK*60	<b>£18.95</b>

**Mechanical Clock Hand Collets, Bergeon**



Mechanical Clocks - Minute & Hour Hand Collets - Bergeon

- Bergeon 10207
- Swiss Made
- High Quality
- Brass
- Various Sizes
- Square Minute
- Round Hour
- 100 pieces

Code	Description	UOM	Price
<b>A6598</b>	Minute & Hour Clock Hand Collets, Bergeon	PACK*100	<b>£64.95</b>

**PILOT HOLE FITTING (COLLET TO SUIT)**

Large range of colleted & non colleted hands for all modern & old clocks

- Dimension = Length of Minute Hand
- All clock hands are measured from collet centre to tip of minute hand.

**Arrow**

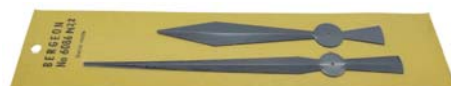

General - All Purpose - 125mm - Non Colleted

- Bergeon 6086 N22
- Black

Collets:  
• Pilot holes for colleting to suit

All measured from minute collet centre to hand tip.

Code	Description	UOM	Price
<b>H0844</b>	125mm Black, Bergeon 6086 N22	PAIR	<b>£3.50</b>

**Baton**



General - Non Colleted

- Bergeon Swiss
- Black
- Multiple sizes

Collets:  
• Pilot holes for colleting to suit

All measured from minute collet centre to hand tip

Code	Description	UOM	Price
<b>H0848</b>	90mm Black, Bergeon 6086 N26	PAIR	<b>£2.95</b>
<b>H0846</b>	135mm Black, Bergeon 6086 N24	PAIR	<b>£5.95</b>

**Starburst**



General - All Purpose - 80mm - Non Colleted

- Bergeon 6086 N11
- Black with Brass Starburst

Collets:  
• Pilot holes for colleting to suit

All measured from minute collet centre to hand tip.

Code	Description	UOM	Price
<b>H0835</b>	80mm Black/Brass, Bergeon 6086 N11	PAIR	<b>£5.75</b>

**Ø1.35MM/Ø2.80MM COLLET FITTING**

All clock hands are measured from collet centre to tip of minute hand.  
• Round Fitting Hour & Minute Hand Collets

**Spade Hour**



Spade Hour - All Purpose - 27mm - Colleted

- Black
- Length 27mm
- For smaller mechanical movements

Collets:  
• Minute: Ø1.35mm  
• Hour: Ø2.80mm

All measured from minute collet centre to hand tip

Code	Description	UOM	Price
<b>H8071</b>	27mm Black, All Purpose	EACH	<b>£2.50</b>

**Ø3.50MM/Ø5.00MM COLLET FITTING**

All clock hands are measured from collet centre to tip of minute hand.

- Round Fitting Hour & Minute Hand Collets

**Vienna Regulator**



Clock Hands - Vienna Regulator (VR)

- Black
- Painted Aluminium
- Made in Germany

Collet Dimensions: Minutes x (Hours)  
• A = Minute: Ø3.5mm & Hour: Ø5.0mm

Lengths are from minute collet centre to hand tip

Code	Description	UOM	Price
<b>H37746</b>	65mm Black Vienna	PAIR	<b>£6.85</b>

**SQ1.50MM & Ø3.00MM COLLET FITTING**

**Serpentine**



Serpentine - All Purpose - 55mm - Colleted

- Mantle Clock
- Brass

Collets:  
• Minute: 1.50mm Square  
• Hour: Ø3.00mm

All measured from minute collet centre to hand tip.

Code	Description	UOM	Price
<b>H8067</b>	55mm Brass, Mantle Clock	EACH	<b>£2.50</b>

**SQ1.75MM & Ø4.50MM COLLET FITTING (SMITHS)**

**Smiths**



Smiths - 8 Day - Clock Hands

- Length 75mm
- Brass

## Collets:

- Minute: 1.75mm Square
- Hour Ø4.50mm

All measured from minute collet centre to hand tip.

Code	Description	UOM	Price
H8068	75mm Brass, Smiths 8 Day	EACH	£7.50

## SQ1.90MM & Ø4.50MM COLLET FITTING

All clock hands are measured from collet centre to tip of minute hand.

- Square Fitting Minute Hand Collets
- Round Fitting Hour Hand Collets

## Carriage Clock, Colleted

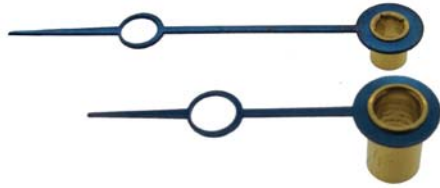

Carriage Clock - Colleted - Moon Shape

- Blued Steel Hand
- Brass Collet
- Moon Shape (H & M)
- Made in Germany

Minute Hand Length:

- 30mm

Collet Dimensions:

- Minute Hand square: 1.90mm
- Hour Hand: Ø4.50mm

Code	Description	UOM	Price
H4942	30mm Carriage Clock Hands	PAIR	£19.95

## SQ2.00MM & Ø4.50MM COLLET FITTING

All clock hands are measured from collet centre to tip of minute hand.

- Square Fitting Minute Hand Collets
- Round Fitting Hour Hand Collets

## Crescent



Clock Hands - Crescent

- 63mm
- Black
- Painted Iron
- Made in China

Collet Dimensions

- Minute Collet: 2.00 x 2.00mm Square
- Hour Collet: Ø4.50mm

Lengths are from minute collet centre to hand tip

Code	Description	UOM	Price
H47628	63mm Hands	PAIR	£2.95
Price breaks available, see website			

## Fancy



Clock Hands - Fancy

- 110mm
- Black
- Painted Iron
- Made in China

Collet Dimensions

- Minute Collet: 2.00 x 2.00mm Square
- Hour Collet: Ø4.50mm

Lengths are from minute collet centre to hand tip

Code	Description	UOM	Price
H47618	110mm Hands	PAIR	£2.95
Price breaks available, see website			

## Fancy



Clock Hands - Fancy

- 90mm
- Black
- Painted Iron
- Made in China

Collet Dimensions

- Minute Collet: 2.00 x 2.00mm Square
- Hour Collet: Ø4.50mm

Lengths are from minute collet centre to hand tip

Code	Description	UOM	Price
H47626	90mm Hands	PAIR	£2.95
Price breaks available, see website			

## Fancy



Clock Hands - Fancy

- 55mm
- Black
- Painted Iron
- Made in China

Collet Dimensions

- Minute Collet: 2.00 x 2.00mm Square
- Hour Collet: Ø4.50mm

Lengths are from minute collet centre to hand tip

Code	Description	UOM	Price
H47624	55mm Hands	PAIR	£2.95
Price breaks available, see website			

## Fancy



Clock Hands - Fancy

- 45mm
- Black
- Painted Iron
- Made in China

Collet Dimensions

- Minute Collet: 2.00 x 2.00mm Square
- Hour Collet: Ø4.50mm

Lengths are from minute collet centre to hand tip

Code	Description	UOM	Price
H47625	45mm Hands	PAIR	£2.95
Price breaks available, see website			



**Contact & Services**

Your direct line to our **Management Team**

All correspondence is time stamped and answered within 1 hour of receipt

**Instant Message Service**

**Fancy**



Clock Hands - Fancy

- 85mm
- Black
- Painted Iron
- Made in China

Collet Dimensions

- Minute Collet: 2.00 x 2.00mm Square
- Hour Collet: Ø4.50mm

Lengths are from minute collet centre to hand tip

Code	Description	UOM	Price
H47629	85mm Hands	PAIR	£2.95
Price breaks available, see website			

**Serpentine**



Clock Hands - Serpentine

- 76 & 120mm
- Black
- Painted Iron
- Made in China

Collet Dimensions

- Minute Collet: 2.00 x 2.00mm Square
- Hour Collet: Ø4.50mm

Lengths are from minute collet centre to hand tip

Code	Description	UOM	Price
H47621	76mm Hands	PAIR	£2.95
H47623	120mm Hands	PAIR	£2.95
H47627	120mm Hands, Matt Finish	PAIR	£2.95
Price breaks available, see website			

**Clock Hand Collet Adjusting Tools**



See Page: 913

**Serpentine**



Clock Hands - Serpentine

- 130mm
- Black
- Painted Iron
- Made in China

Collet Dimensions

- Minute Collet: 2.00 x 2.00mm Square
- Hour Collet: Ø4.50mm

Lengths are from minute collet centre to hand tip

Code	Description	UOM	Price
H47619	130mm Hands	PAIR	£2.95
Price breaks available, see website			

**Spade Hour & Minute**



Clock Hands - Spade Hour & Minute

- 65 & 90mm
- Black
- Painted Iron
- Made in China

Collet Dimensions

- Minute Collet: 2.00 x 2.00mm Square
- Hour Collet: Ø4.50mm

Lengths are from minute collet centre to hand tip

Code	Description	UOM	Price
H47622	65mm Hands	PAIR	£2.95
H47620	90mm Hands	PAIR	£2.95
Price breaks available, see website			

**Vienna Regulator**



Clock Hands - Vienna Regulator (VR)

- 65 or 88mm
- Black or gold
- Painted Aluminium
- Made in Germany

Collet Dimensions

- Minute Collet: 2.00 x 2.00mm Square
- Hour Collet: Ø4.50mm

Lengths are from minute collet centre to hand tip

Code	Description	UOM	Price
H37747	65mm Black Vienna	PAIR	£8.25
H37752	88mm Gold Vienna	PAIR	£14.65
H37749	88mm Black Vienna	PAIR	£6.25
Price breaks available, see website			

**SQ2.00MM & Ø4.50MM COLLET FITTING (FRENCH)**

All clock hands are measured from collet centre to tip of minute hand.

- Square Fitting Minute Hand Collets
- Round Fitting Hour Hand Collets

**Fleur De Lys French Clock**

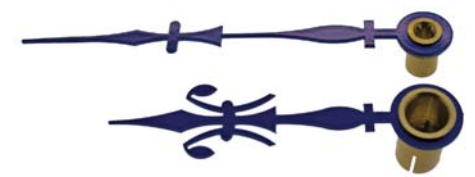

French Clock Clover Hands - Fleur De Lys Style

Specification:

- Blued Steel Hands
- Brass Split Hour Collets Ø4.50mm
- Brass Minute Collets 2.00mm Square
- Dimension given is from the centre of the minute hand collet to the hand tip
- Can be adapted to fit
- Made in Germany

Code	Description	UOM	Price
H0807	40mm French Clock, Fleur De Lys	PAIR	£16.95
H0808	50mm French Clock, Fleur De Lys	PAIR	£16.95
H0809	60mm French Clock, Fleur De Lys	PAIR	£16.95

**Moon French Clock**

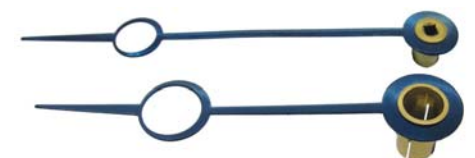

French Clock Clover Hands - Moon Style

Specification:

- Blued Steel Hands
- Brass Split Hour Collets Ø4.50mm
- Brass Minute Collets 2.00mm Square
- Dimension given is from the centre of the minute hand collet to the hand tip
- Can be adapted to fit
- Made in Germany

Code	Description	UOM	Price
H0810	30mm French Clock, Moon	PAIR	£12.50
H0811	40mm French Clock, Moon	PAIR	£12.50
H0812	50mm French Clock, Moon	PAIR	£13.45
H0813	60mm French Clock, Moon	PAIR	£14.20

**Beeswax Block**

See Page 1170



## Spade French Clock



French Clock Clover Hands - Spade Style

Specification:

- Blued Steel Hands
- Brass Split Hour Collets Ø4.50mm
- Brass Minute Collets 2.00mm Square
- Dimension given is from the centre of the minute hand collet to the hand tip
- Can be adapted to fit
- Made in Germany

Code	Description	UOM	Price
H0814	40mm French Clock, Spade	PAIR	£12.50
H0815	50mm French Clock, Spade	PAIR	£13.45
H0816	60mm French Clock, Spade	PAIR	£14.20
H7528	70mm French Clock, Spade	PAIR	£14.50

## Trefle (Clover) French Clock

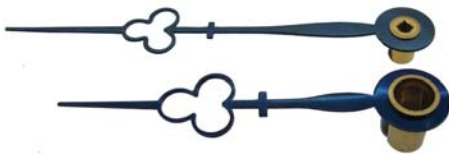

French Clock Trefle Hands - Trefle (Clover) Style

Specification:

- Blued Steel Hands
- Brass Split Hour Collets Ø4.50mm, 7mm long
- Brass Minute Collets 2.00mm Square
- Dimension given is from the centre of the minute hand collet to the hand tip
- Can be adapted to fit
- Made in Germany

Code	Description	UOM	Price
H0804	40mm French Clock, Clover	PAIR	£15.50
H0805	50mm French Clock, Clover	PAIR	£15.75
H0806	60mm French Clock, Clover	PAIR	£15.95

**SQ2.00MM & Ø4.50MM COLLET FITTING (HERMLE)**

All clock hands are measured from collet centre to tip of minute hand.

- Square Fitting Minute Hand Collets
- Round Fitting Hour Hand Collets

## Arrow Hands, Hermle



Hermle - Colleted - Clock Hands - Arrow

- Standard Hermle Mechanical Fit
- Arrow shape
- Black & Brass

Collets:

- Minute: 2.00mm Square
- Hour: Ø4.50mm Round

All measured from minute collet centre to hand tip.

Code	Description	UOM	Price
H8216	80mm Black Arrow	PAIR	£3.95
H8215	90mm Black Arrow	PAIR	£3.95

## Moon Hands, Hermle



Hermle - Colleted - Clock Hands - Moon

- Standard Hermle Mechanical Fit
- Moon shape
- Black

Collets:

- Minute: 2.00mm Square
- Hour: Ø4.50mm Round

All measured from minute collet centre to hand tip.

Code	Description	UOM	Price
H42018	85mm Black Moon	PAIR	£4.50

## Spade Hands, Hermle



Hermle - Colleted - Clock Hands - Spade

- Standard Hermle Mechanical Fit
- Spade shape
- Black

Collets:

- Minute: 2.00mm Square
- Hour: Ø4.50mm Round

All measured from minute collet centre to hand tip.

Code	Description	UOM	Price
H8217	75mm Black Spade	PAIR	£4.50
H42015	87mm Black Spade	PAIR	£4.50

## Serpentine Hands, Hermle (Flat Profile)



Hermle - Colleted - Clock Hands - Serpentine

- Standard Hermle Mechanical Fit
- Serpentine shape
- Flat profile
- Black & Brass

Collets:

- Minute: 2.00mm Square
- Hour: Ø4.50mm Round

All measured from minute collet centre to hand tip.

Code	Description	UOM	Price
H42010	46mm Black Serpentine	PAIR	£3.95
H42009	63mm Black Serpentine	PAIR	£3.95

H42008	69mm Black Serpentine	PAIR	£3.95
H8223	76mm Black Serpentine	PAIR	£3.95
H8221	88mm Black Serpentine	PAIR	£3.95
H8222	88mm Brass Serpentine	PAIR	£3.95
H8219	103mm Black Serpentine	PAIR	£3.95
H8220	103mm Brass Serpentine	PAIR	£3.95
H8218	120mm Black Serpentine	PAIR	£3.95
H42006	120mm Black Serpentine, 471 Series	PAIR	£3.95

## Serpentine Hands, Hermle (Raised Profile)



Hermle - Colleted - Clock Hands - Serpentine

- Standard Hermle Mechanical Fit
- Serpentine shape
- Raised profile
- Black

Collets:

- Minute: 2.00mm Square
- Hour: Ø4.50mm Round

All measured from minute collet centre to hand tip.

Code	Description	UOM	Price
H42011	76mm Black Serpentine	PAIR	£4.50
H41997	88mm Black Serpentine	PAIR	£4.50

## Tapered Hands, Hermle



Hermle - Colleted - Clock Hands - Tapered

- Standard Hermle Mechanical Fit
- Fancy shape
- Black

Collets:

- Minute: 2.00mm Square
- Hour: Ø4.50mm Round

All measured from minute collet centre to hand tip.

Code	Description	UOM	Price
H42016	88mm Black Hands	PAIR	£4.50

## Vienna Hands, Hermle



Hermle - Colleted - Clock Hands - Vienna

- Standard Hermle Mechanical Fit
- Vienna shape
- Black

Collets:

- Minute: 2.00mm Square
- Hour: Ø4.50mm Round

All measured from minute collet centre to hand tip.

Code	Description	UOM	Price
H42013	68mm Black Vienna	PAIR	£4.50

## SQ2.45MM & Ø4.00, 5.40MM COLLET FITTING (CUCKOO)

All clock hands are measured from collet centre to tip of minute hand.

### Cuckoo Hands per Pair



Cuckoo Clock - Traditional Shape

- White Acrylic Hands
- Minute Hand Lengths from 33mm to 85mm
- Hour hand fitting Ø4.00mm
- Minute hand fitting Ø5.40mm
- Supplied with minute hand brass bush with a 2.45mm square fitting
- Original Black Forest cuckoo clock parts
- Made in Germany
- Dimensions: Minute hand length - hour hand length

Cuckoo hands minute and hour lengths are from collet centre to hand tip

Code	Description	UOM	Price
H35879	33 - 27mm Cuckoo Clock Hands	PAIR	£0.95
H4886	36 - 30mm Cuckoo Clock Hands	PAIR	£0.95
H4887	42 - 31mm Cuckoo Clock Hands	PAIR	£0.95
H4890	48 - 42mm Cuckoo Clock Hands	PAIR	£1.50
H35880	56 - 48mm Cuckoo Clock Hands	PAIR	£1.75
H43146	64 - 49mm Cuckoo Clock Hands	PAIR	£2.50
H35878	72 - 56mm Cuckoo Clock Hands	PAIR	£2.50
H4893	85 - 76mm Cuckoo Clock Hands	PAIR	£2.85
B44278	Bush for Cuckoo Clock Hands	EACH	£0.25

Price breaks available, see website

### Cuckoo Hands per Pack



Cuckoo Clock - Traditional Shape

- White Acrylic Hands
- Round Hole for Hour
- Small & Large Sizes
- Made in Germany

Minute Hand Brass Collet:

- 2.40mm Square
- Ø5.30mm Hand Fitting
- Ø7.50mm Outside Diameter

Small Set of 8 Pair:

- 2 of each pair
- Collet & non collet version of each size
- 28/23mm, 36/32mm, 43/32mm, 48/42mm

Large Set of 6 Pair:

- 2 of each pair

- Collet & non collet version of each size
- 63/49mm, 70/55mm, 86/67mm

Cuckoo hands minute and hour lengths are from collet centre to hand tip.

Code	Description	UOM	Price
H32156	Cuckoo Hand Set ( Small Sizes )	8 PAIR	£12.95
H32157	Cuckoo Hand Set ( Large Sizes )	6 PAIR	£23.95

## SQ3.30MM & Ø4.50MM COLLET FITTING (SEIKOSHA)

### Seikosha Hands



Seikosha clock hands

- For Seikosha clocks
- Black
- Hour collet Ø4.50mm
- Minute collet: 3.30 x 3.30mm

Dimensions from minute collet centre to hand tip

Dimensions approx.

Code	Description	UOM	Price
H39695	63mm Seikosha Clock Hands	PAIR	£0.95
H39696	85mm Seikosha Clock Hands	PAIR	£0.95
H39697	135mm Seikosha Clock Hands	PAIR	£0.95

## SQ3.50MM & Ø6.00MM COLLET FITTING (LONGCASE)

All clock hands are measured from collet centre to tip of minute hand.

- Square Fitting Minute Hand Collets
- Round Fitting Hour Hand Collets

### Hour & Minute Longcase

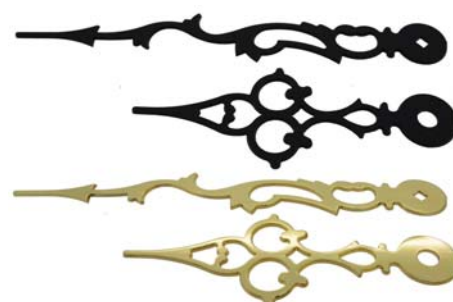

Long Case Clock Hands - Hour & Minute

- Serpentine

- Black & Brass
- Heavy Gauge (1.20mm Thick)
- High Quality
- Minute Hand Length 140mm
- Made in UK

Collets:

- Minute Square: 3.50mm
- Hour: Ø6.00mm

All measured from minute collet centre to hand tip.

Code	Description	UOM	Price
H0817	140mm Black, Long Case	PAIR	£9.95
H0818	140mm Brass, Long Case	PAIR	£10.95

## SECONDS HANDS

### Longcase Seconds Hand



Long Case Clock Hands - Small Seconds

- Fancy Pattern
- Black & Brass
- High Quality
- Drilled & Split Brass Collet
- Made in UK

Dimensions:

- Hand Length 48mm
- Collet Depth 31mm

All measured from collet centre to hand tip.

Code	Description	UOM	Price
H0819	48mm Black, Seconds	EACH	£6.80
H0820	48mm Brass, Seconds	EACH	£6.95

### Longcase Seconds Hand Pipe



Long Case Clock - Seconds Hand Pipe

Seconds Pipe blank for long case clocks, 1/8" (Ø3.20mm) x 2" (52mm) long with a small shoulder turned to mount the hand. Part pilot drilled at opposite end.

- Length 52mm (to be cut down)
- Ø3.20mm
- Made in UK

Code	Description	UOM	Price
L33584	Long Case Seconds Hand Pipe	EACH	£1.50

### Seconds Hand, Vienna Regulator

Vienna Regulator (VR) Clock Seconds Hand



- Black Hand
- Brass Collet
- Vienna Regulator (VR)
- Length: 25mm
- Collet Length: 11mm (drilled & split)
- Collet diameter: Ø2.90 x Ø1.45mm (outer x inner)
- Made in India

Lengths are from minute collet centre to hand tip.

Code	Description	UOM	Price
H0825	VR Seconds Hand	EACH	£3.95

**SUBSIDIARY HANDS, CALENDER/SMALL SECONDS**

Dimensions:  
 • Hand collet to tip length (overall height)

Code	Description	UOM	Price
H42030	20mm (14.50mm) Hand	EACH	£3.95
H42031	20mm (35.00mm) Hand	EACH	£3.95

**Alarm Clock Small Seconds Hand**

Alarm Clock Small Seconds Hand, Short Cannon with Counter Balance

- Blued Steel Hand
- Brass Collet
- Short Cannon
- Counter Balanced



Dimensions:  
 • Hand length: 10mm  
 • Hand collet hole: 0.40mm (pin hole)  
 • Collet outside: Ø2.00mm  
 • Collet depth: Ø 2.00mm

Code	Description	UOM	Price
H19753	Alarm Clock Hand, Short Cannon With Counter Balance	EACH	£6.95

**Alarm Clock Small Seconds Hand with Long Cannon**

Alarm Clock Small Seconds Hand, Long Cannon

- Blued Steel Hand
- Split Brass Collet
- Long Cannon



Dimensions:  
 • Hand length: 10mm  
 • Collet outside: Ø2.60mm  
 • Collet depth: 11mm

Code	Description	UOM	Price
H19751	Alarm Clock Hand, Long Cannon Without Counter Balance	EACH	£8.95

**Alarm Clock Small Seconds Hand with Long Cannon & Counter Balance**

Alarm Clock Small Seconds Hand, Long Cannon with Counter Balance

- Blued Steel Hand
- Split Brass Collet
- Long Cannon
- Counter Balanced



Dimensions:  
 • Hand length: 11mm  
 • Collet outside: Ø2.60mm  
 • Collet depth: 11mm

Code	Description	UOM	Price
H19752	Alarm Clock Hand, Long Cannon With Counter Balance	EACH	£8.95

**Hermle Calender & Small Seconds Hands**

Hermle - Calender Hands - Small Seconds Hands

- 20mm (Measured from collet centre to hand tip)
- 20 or 35mm overall height
- Ø2.30mm pipe diameter
- Back
- Made in Germany



**HANDS & HAND COLLETS (CLOCK) QUARTZ**

**CARRIAGE CLOCK HANDS**

Carriage clock hands are suitable for our UTS & Seiko carriage clock quartz clock movements.

Carriage Clock Hand Collet Dimensions:

- Minute: Ø1.95mm
- Hour: Ø3.35mm
- Centre Seconds: Ø0.25mm
- Alarm hand: Ø5.00mm

All clock hands are measured from collet centre to tip of minute hand.

Carriage Clock Movement Collet Dimensions:

- UTS movements: Minute = Ø1.95mm, Hour = Ø3.35mm
- Seiko movements: Minute = Ø1.90mm, Hour = Ø3.09mm

The hands are generic and can be adjusted to fit. The hand collets may require slots being cut for pinching (by using a piercing saw) and/or the collet can be shortened by filing.

**Alarm Hand**



- Carriage clock alarm indicator hand
- Ø5.00mm collet
- Silver
- Push on fitting
- Metal

All clock hands are measured from collet centre to tip of minute hand

The hands are generic and can be adjusted to fit. The hand collets may require slots being cut for pinching (by using a piercing saw) and/or the collet can be shortened by filing.

Code	Description	UOM	Price
J3303	Alarm Indicator Hand, Silver 30mm	EACH	£0.75

**Centre Seconds Hands**



- Carriage clock centre seconds hands

- Ø0.25mm fitting
- Black
- Plastic
- With or without tail

All clock hands are measured from collet centre to tip of minute hand

The hands are generic and can be adjusted to fit. The hand collets may require slots being cut for pinching (by using a piercing saw) and/or the collet can be shortened by filing.

Code	Description	UOM	Price
H340122	25mm Centre Seconds Hand	EACH	£0.75
H48051	35mm Centre Seconds Hand	EACH	£0.75

**Hour & Minute Hands, Baton**



- Carriage clock baton hour & minute hands
- Minute hand collet Ø1.95mm
- Hour hand collet Ø3.35mm
- Black
- Metal

All clock hands are measured from collet centre to tip of minute hand

The hands are generic and can be adjusted to fit. The hand collets may require slots being cut for pinching (by using a piercing saw) and/or the collet can be shortened by filing.

Code	Description	UOM	Price
H47899	30mm (Carriage) Black	PAIR	£1.95
H47897	40mm (Carriage) Black	PAIR	£1.95

**Hour & Minute Hands, Baton Hollow**



- Carriage clock hollow baton hour & minute hands
- Minute hand collet Ø1.95mm
- Hour hand collet Ø3.35mm
- Black
- Metal

All clock hands are measured from collet centre to tip of minute hand

The hands are generic and can be adjusted to fit. The hand collets may require slots being cut for pinching (by using a piercing saw) and/or the collet can be shortened by filing.

Code	Description	UOM	Price
H47489	22mm (Carriage) Black	PAIR	£1.50
H47490	22mm (Carriage) White	PAIR	£1.50



**Hour & Minute Hands, Baton Thin**



- Carriage clock thin baton hour & minute hands
- Minute hand collet Ø1.95mm
- Hour hand collet Ø3.35mm
- White
- Metal

All clock hands are measured from collet centre to tip of minute hand

The hands are generic and can be adjusted to fit. The hand collets may require slots being cut for pinching (by using a piercing saw) and/or the collet can be shortened by filing.

Code	Description	UOM	Price
H47898	40mm (Carriage) White	PAIR	£1.95

**Hour & Minute Hands, Spade Hour**



- Carriage clock spade hour & minute hands
- Minute hand collet Ø1.95mm
- Hour hand collet Ø3.35mm
- Black
- Plastic

All clock hands are measured from collet centre to tip of minute hand

The hands are generic and can be adjusted to fit. The hand collets may require slots being cut for pinching (by using a piercing saw) and/or the collet can be shortened by filing.

Code	Description	UOM	Price
H35347	24mm (Carriage) Black	PAIR	£1.50
H35346	32mm (Carriage) Black	PAIR	£1.50

**Hour & Minute Hands, Spade Hour & Minute**



- Carriage clock spade hour & spade minute hands
- Minute hand collet Ø1.95mm
- Hour hand collet Ø3.35mm

- Black
- Metal

All clock hands are measured from collet centre to tip of minute hand

The hands are generic and can be adjusted to fit. The hand collets may require slots being cut for pinching (by using a piercing saw) and/or the collet can be shortened by filing.

Code	Description	UOM	Price
H47900	42mm (Carriage) Black	PAIR	£1.95

**CENTRE SECONDS (EF & NEF) HANDS**

Centre Seconds Hands are suitable for Euro shaft fitting (EF) & non Euro shaft fitting (NEF) quartz clock movements

All measured from collet centre to hand tip.

The hands are generic and are likely to require pinching to fit.

**Centre Seconds, Style 1**



Quartz Clock Hands - Euro Fitting (EF) or Non Euro Fitting (NEF) - Center Seconds

- Black
- Red
- Euro Fitting (EF) or Non Euro Fitting (NEF)
- Made in Germany (DE) or made in China (CH)

All measured from collet centre to hand tip. The hands are generic and are likely to require pinching to fit.

Code	Description	UOM	Price
H45992	73mm (EF & NEF) Black, CH	EACH	£0.50
H45993	73mm (EF & NEF) Red, CH	EACH	£0.50
J3305	100mm (EF & NEF) Black, DE	EACH	£1.20
J3304	100mm (EF & NEF) Red, DE	EACH	£1.20
H45990	115mm (EF & NEF) Black, CH	EACH	£0.50
H45991	115mm (EF & NEF) Red, CH	EACH	£0.50

Price breaks available, see website

**Centre Seconds, Style 2**

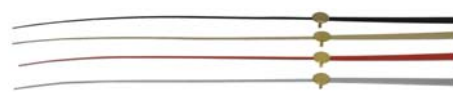

Quartz Clock Hands - Euro Fitting (EF) or Non Euro Fitting (NEF)

- Black
- Gold
- Red
- Silver
- Euro Fitting (EF) or Non Euro Fitting (NEF)
- Made in China

Dimensions:  
• Length 128mm

All measured from collet centre to hand tip. The hands are generic and are likely to require pinching to fit.

Code	Description	UOM	Price
H20305J	128mm (EF & NEF) Black	EACH	£0.70
H20305G	128mm (EF & NEF) Gold	EACH	£0.70
H20305K	128mm (EF & NEF) Red	EACH	£0.70
H20305H	128mm (EF & NEF) Silver	EACH	£0.70

Price breaks available, see website

**EURO FITTING (EF) HANDS**

Euroshaft (EF) quartz hands are suitable for our EF UTS, radio controlled, synchronous mains, Seiko & Hermle quartz clock movements

Euro Fitting (EF) Collet Dimensions:

- Minute: 3.50 x 2.80mm
- Hour: Ø5.00mm

All clock hands are measured from collet centre to tip of minute hand.

The hands are generic and can be adjusted to fit. The hand collets may require slots being cut for pinching (by using a piercing saw) and/or the collet can be shortened by filing.

**Set & Replacements**



Quartz Clock Hands - Euro Fitting (EF) - Set & Replacements

Collet Dimensions:

- Minute: 3.5 x 2.8mm
- Hour: Ø5.0mm

Box Set Contains:

- 12 Pairs
- 12 Centre Seconds

Hour & Minute Hands in Black:

- H20305A – Black 91mm 2 Pair
- H20305B – Black 107mm 2 Pair
- H20305C – Black 108mm 2 Pair
- H20305D – Black 132mm 2 Pair
- H20305E – Black 130mm 2 Pair
- H20305F – Black 170mm 2 Pair

Center Seconds Hands (may require pinching to fit):

- H20305G – Gold 128mm 6 Pieces
- H20305H – Silver 128mm 2 Pieces
- H20305J – Black 128mm 2 Pieces
- H20305K – Red 128mm 2 Pieces

The hands are generic and can be adjusted to fit. The hands are generic and can be adjusted to fit. The hand collets may require slots being cut for pinching (by using a piercing saw) and/or the collet can be shortened by filing.

Code	Description	UOM	Price
H20305	Set of EF Quartz Clock Hands	EACH	£9.95
H20305A	91mm (EF) Black, Fancy	EACH	£0.75
H20305B	107mm (EF) Black, Spear	EACH	£0.75
H20305C	108mm (EF) Black, Baton	EACH	£0.75
H20305E	130mm (EF) Black, Bold	EACH	£0.75
H20305D	132mm (EF) Black, Spade	EACH	£0.75
H20305F	170mm (EF) Black, Pointed	EACH	£0.75

Price breaks available, see website

**PRICE PROMISE GUARANTEE** ✓

**TODAY** SAME DAY DISPATCH

## 225mm (XL) High Torque



Quartz Clock Hands - Euro Fitting (EF) - Baton - XL (High Torque)

- Black
- Euro Fitting (EF)
- Minute length 225mm
- Hour length 180mm
- Width 10mm
- Aluminium
- Made in Germany

Collet Dimensions:

- Minute: 3.5 x 2.8mm
- Hour: Ø5.0mm

All measured from minute collet centre to hand tip.

The hands are generic and can be adjusted to fit. The hand collets may require slots being cut for pinching (by using a piercing saw) and/or the collet can be shortened by filing.

Code	Description	UOM	Price
J3306	225mm (EF) Black, XL	PAIR	£5.95

## 400mm (XL) High Torque



Quartz Clock Hands - Euro Fitting (EF) - Pointed - XL (High Torque)

- Black
- Euro Fitting (EF)
- Minute length 400mm
- Hour length TBAm
- Width TBAm
- Aluminium
- Made in Germany

Collet Dimensions:

- Minute: 3.5 x 2.8mm
- Hour: Ø5.0mm

All measured from minute collet centre to hand tip.

The hands are generic and can be adjusted to fit. The hand collets may require slots being cut for pinching (by using a piercing saw) and/or the collet can be shortened by filing.

Code	Description	UOM	Price
J48662	400mm (EF) Black	PAIR	£14.50

## Baton with Tail



Quartz Clock Hands - Euro Fitting (EF) - Baton with Tail

Cousins\* = Click Website "Bulk Savings" icon for Big Discounts

- Black
- Chrome (100mm only)
- Gold
- White (100mm only)
- Euro Fitting (EF)
- Aluminium
- Made in Germany

Dimensions:

- Minute Length (Minute Width x Hour Width)

Collet Dimensions:

- Minute: 3.5 x 2.8mm
- Hour: Ø5.0mm

All measured from minute collet centre to hand tip.

The hands are generic and can be adjusted to fit. The hand collets may require slots being cut for pinching (by using a piercing saw) and/or the collet can be shortened by filing.

Cousins\* = Click Website "Bulk Savings" icon for Big Discounts

Code	Description	UOM	Price
J46572	36mm (2.10 x 3.60mm), Black	PAIR	£1.20
J46573	36mm (2.10 x 3.60mm), Gold	PAIR	£1.40
J3223	41mm (3.00 x 4.00mm), Black	PAIR	£1.00
J3224	41mm (3.00 x 4.00mm), Gold	PAIR	£1.40
J3225	52mm (3.00 x 4.00mm), Black	PAIR	£1.00
J3226	52mm (3.00 x 4.00mm), Gold	PAIR	£1.40
J3227	64mm (3.00 x 3.00mm), Black	PAIR	£1.20
J3228	64mm (3.00 x 3.00mm), Gold	PAIR	£1.40
J46574	70mm (3.00 x 4.00mm), Black	PAIR	£1.70
J46575	70mm (3.00 x 4.00mm), Gold	PAIR	£2.00
J3229	80mm (3.00 x 4.00mm), Black	PAIR	£1.60
J3230	80mm (3.00 x 4.00mm), Gold	PAIR	£2.00
J3231	100mm (3.00 x 4.00mm), Black	PAIR	£1.15
J3232	100mm (3.00 x 4.00mm), Gold	PAIR	£2.00
J3233	100mm (3.00 x 4.00mm), Chrome	PAIR	£1.90
J3234	100mm (3.00 x 4.00mm), White	PAIR	£2.20
H49002	106mm (3.20 x 5.10mm), Black, Cousins*	PAIR	£0.95
H49003	106mm (3.20 x 5.10mm), Gold, Cousins*	PAIR	£0.95
H49000	108mm (3.20 x 3.20mm), Black, Cousins*	PAIR	£0.95
H49001	108mm (3.20 x 3.20mm), Gold, Cousins*	PAIR	£0.95
H49004	120mm (4.60 x 6.00mm), Black, Cousins*	PAIR	£0.95
H49005	120mm (4.60 x 6.00mm), Gold, Cousins*	PAIR	£0.95
J3235	120mm (5.00 x 5.00mm), Black	PAIR	£1.80
J3236	120mm (5.00 x 5.00mm), Gold	PAIR	£2.20
J3237	135mm (3.75 x 3.75mm), Black	PAIR	£2.00
J3238	135mm (3.75 x 3.75mm), Gold	PAIR	£2.30
J46576	140mm (3.75 x 3.75mm), Black	PAIR	£2.00
J46577	140mm (3.75 x 3.75mm), Gold	PAIR	£2.30
H49006	161mm (5.60 x 5.20mm), Black, Cousins*	PAIR	£0.95
H49007	161mm (5.60 x 5.20mm), Gold, Cousins*	PAIR	£0.95
H49009	161mm (5.60 x 5.20mm), Chrome, Cousins*	PAIR	£0.95
H49008	161mm (5.60 x 5.20mm), White, Cousins*	PAIR	£0.95

Price breaks available, see website

## Baton without Tail



Quartz Clock Hands - Euro Fitting (EF) - Baton without Tail

- Black
- Euro Fitting (EF)
- Aluminium
- Made in Germany

Collet Dimensions:

- Minute: 3.5 x 2.8mm
- Hour: Ø5.0mm

All measured from minute collet centre to hand tip.

The hands are generic and can be adjusted to fit. The hand collets may require slots being cut for pinching (by using a piercing saw) and/or the collet can be shortened by filing.

Code	Description	UOM	Price
J3294	55mm (EF) Black	PAIR	£1.50

## Baton, Super Slim



Quartz Clock Hands - Euro Fitting (EF) - Baton Super Slim

- Black or gold
- Euro Fitting (EF)
- Aluminium
- Made in Germany

Collet Dimensions:

- Minute: 3.5 x 2.8mm
- Hour: Ø5.0mm

All measured from minute collet centre to hand tip.

The hands are generic and can be adjusted to fit. The hand collets may require slots being cut for pinching (by using a piercing saw) and/or the collet can be shortened by filing.

Code	Description	UOM	Price
J46568	25mm (EF) Black	PAIR	£1.00
J46569	25mm (EF) Gold	PAIR	£1.20
J46570	30mm (EF) Black	PAIR	£1.20
J46571	30mm (EF) Gold	PAIR	£1.40

## Cathedral



Quartz Clock Hands - Euro Fitting (EF) - Cathedral

Cousins\* = Click Website "Bulk Savings" icon for Big Discounts

- Black
- Gold
- Euro Fitting (EF)
- Aluminium
- Made in Germany

Collet Dimensions:

- Minute: 3.5 x 2.8mm



• Hour: Ø5.0mm

All measured from minute collet centre to hand tip.

The hands are generic and can be adjusted to fit. The hand collets may require slots being cut for pinching (by using a piercing saw) and/or the collet can be shortened by filing.

Cousins\* = Click Website "Bulk Savings" icon for Big Discounts

Code	Description	UOM	Price
J46474	26mm (EF) Black	PAIR	£1.00
J3280	30mm (EF) Black	PAIR	£1.00
J3281	30mm (EF) Gold	pair	£1.25
J46476	35mm (EF) Black	PAIR	£1.00
J46477	35mm (EF) Gold	PAIR	£1.40
J3282	38mm (EF) Black	PAIR	£1.30
J3283	38mm (EF) Gold	PAIR	£1.50
J3284	49mm (EF) Black	PAIR	£1.50
J3285	49mm (EF) Gold	PAIR	£1.75
H49011	52mm (EF) Black, Cousins*	PAIR	£0.95
H49012	52mm (EF) Gold, Cousins*	PAIR	£0.95
J46478	72mm (EF) Black	PAIR	£1.50
J46479	72mm (EF) Gold	PAIR	£1.75
J46480	80mm (EF) Black	PAIR	£2.00
J46481	80mm (EF) Gold	PAIR	£2.00

Price breaks available, see website

**Crescent**



Quartz Clock Hands - Euro Fitting (EF) - Crescent

Cousins\* = Click Website "Bulk Savings" icon for Big Discounts

- Black
- Gold
- Euro Fitting (EF)
- Fancy Crescent shape
- Aluminium
- Made in Germany

Collet Dimensions:  
 • Minute: 3.5 x 2.8mm  
 • Hour: Ø5.0mm

The hands are generic and can be adjusted to fit. The hand collets may require slots being cut for pinching (by using a piercing saw) and/or the collet can be shortened by filing.

Cousins\* = Click Website "Bulk Savings" icon for Big Discounts

Code	Description	UOM	Price
J46560	26mm (EF) Black	PAIR	£1.10
J46561	26mm (EF) Gold	PAIR	£1.25
J46562	50mm (EF) Black	PAIR	£1.30
J46563	50mm (EF) Gold	PAIR	£1.50
H49025	63mm (EF) Black, Cousins*	PAIR	£0.95
J46564	70mm (EF) Black	PAIR	£1.70
J46565	70mm (EF) Gold	PAIR	£1.95
J46566	80mm (EF) Black	PAIR	£2.00
J46567	80mm (EF) Gold	PAIR	£2.30

Price breaks available, see website

**Fancy**



Quartz Clock Hands - Euro Fitting (EF) - Fancy

- Black
- Gold
- Euro Fitting (EF)
- Aluminium
- Made in Germany

Collet Dimensions:  
 • Minute: 3.5 x 2.8mm  
 • Hour: Ø5.0mm

All measured from minute collet centre to hand tip.

The hands are generic and can be adjusted to fit. The hand collets may require slots being cut for pinching (by using a piercing saw) and/or the collet can be shortened by filing.

Code	Description	UOM	Price
J3262	33mm (EF) Black	PAIR	£1.00
J3263	33mm (EF) Gold	PAIR	£1.10
J5721	46mm (EF) Black	PAIR	£1.00
J5714	46mm (EF) Gold	PAIR	£1.30

**Fancy**



Quartz Clock Hands - Euro Fitting (EF) - Fancy - Superior Quality

- Black
- Gold
- Euro Fitting (EF)
- Aluminium
- Superior Quality
- Made in Germany

Collet Dimensions:  
 • Minute: 3.5 x 2.8mm  
 • Hour: Ø5.0mm

All measured from minute collet centre to hand tip.

The hands are generic and can be adjusted to fit. The hand collets may require slots being cut for pinching (by using a piercing saw) and/or the collet can be shortened by filing.

Code	Description	UOM	Price
H0827	80mm Brass, Superior Quality	PAIR	£11.95
H0833	80mm Black, Superior Quality	PAIR	£8.95

**Fleur De Lys**



Quartz Clock Hands - Euro Fitting (EF) - Fleur De Lys

- Black
- Gold
- Euro Fitting (EF)
- Aluminium
- Made in Germany

Collet Dimensions:  
 • Minute: 3.5 x 2.8mm  
 • Hour: Ø5.0mm

All measured from minute collet centre to hand tip.

The hands are generic and can be adjusted to fit. The hand collets may require slots being cut for pinching (by using a piercing saw) and/or the collet can be shortened by filing.

Code	Description	UOM	Price
J3288	23mm (EF) Black	PAIR	£1.30
J3289	23mm (EF) Gold	PAIR	£1.50
J46498	34mm (EF) Black	PAIR	£1.30
J46499	34mm (EF) Gold	PAIR	£1.50

**Fleur De Lys**

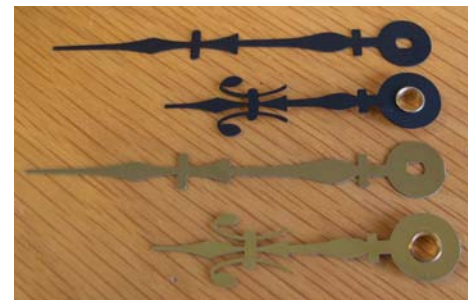

Quartz Clock Hands - Euro Fitting (EF) - Fleur De Lys

- Black
- Gold
- Euro Fitting (EF)
- Aluminium
- Made in Germany

Collet Dimensions:  
 • Minute: 3.5 x 2.8mm  
 • Hour: Ø5.0mm

All measured from minute collet centre to hand tip.

The hands are generic and can be adjusted to fit. The hand collets may require slots being cut for pinching (by using a piercing saw) and/or the collet can be shortened by filing.

Code	Description	UOM	Price
J46500	40mm (EF) Black	PAIR	£1.20
J46501	40mm (EF) Gold	PAIR	£1.40
J46502	50mm (EF) Black	PAIR	£1.30
J46503	50mm (EF) Gold	PAIR	£1.50

**PRICE PROMISE  
 GUARANTEE**

**SAME DAY DISPATCH**

# HANDS & HAND COLLETS (CLOCK) QUARTZ

J46504	58mm (EF) Black	PAIR	£1.70
J46505	58mm (EF) Gold	PAIR	£1.95
J46506	58mm (EF) Gold	PAIR	£1.60
J46507	73mm (EF) Gold	PAIR	£1.85
J46508	85mm (EF) Black	PAIR	£1.70
J46509	85mm (EF) Gold	PAIR	£1.95

## Gothic



Quartz Clock Hands - Euro Fitting (EF) - Gothic

- Black
- Gold
- Euro Fitting (EF)
- Aluminium
- Made in Germany

Collet Dimensions:  
 • Minute: 3.5 x 2.8mm  
 • Hour: Ø5.0mm

All measured from minute collet centre to hand tip.

The hands are generic and can be adjusted to fit. The hand collets may require slots being cut for pinching (by using a piercing saw) and/or the collet can be shortened by filing.

Code	Description	UOM	Price
J46482	39mm (EF) Black	PAIR	£1.00
J46483	39mm (EF) Gold	PAIR	£1.20
J3278	46mm (EF) Black	PAIR	£1.20
J3279	46mm (EF) Gold	PAIR	£1.30
J3260	80mm (EF) Black	PAIR	£1.50
J3261	80mm (EF) Gold	PAIR	£1.85

## Moon



Quartz Clock Hands - Euro Fitting (EF) - Moon

- Black
- Gold
- Euro Fitting (EF)
- Aluminium
- Made in Germany

Collet Dimensions:  
 • Minute: 3.5 x 2.8mm  
 • Hour: Ø5.0mm

All measured from minute collet centre to hand tip.

The hands are generic and can be adjusted to fit. The hand collets may require slots being cut for pinching (by using a piercing saw) and/or the collet can be shortened by filing.

Code	Description	UOM	Price
J46486	24mm (EF) Black	PAIR	£1.20
J46487	24mm (EF) Gold	PAIR	£1.40
J3286	28mm (EF) Black	PAIR	£1.10
J3287	28mm (EF) Gold	PAIR	£1.30
J46488	30mm (EF) Black	PAIR	£1.20
J46489	30mm (EF) Gold	PAIR	£1.40
J46490	62mm (EF) Black	PAIR	£1.40
J46491	62mm (EF) Gold	PAIR	£1.65

## Pointed



Quartz Clock Hands - Euro Fitting (EF) - Pointed

- Black
- Gold
- Euro Fitting (EF)
- Flat hands
- Aluminium
- Made in Germany

Collet Dimensions:  
 • Minute: 3.5 x 2.8mm  
 • Hour: Ø5.0mm

All measured from minute collet centre to hand tip.

The hands are generic and can be adjusted to fit. The hand collets may require slots being cut for pinching (by using a piercing saw) and/or the collet can be shortened by filing.

Code	Description	UOM	Price
J3239	50mm (EF) Black	PAIR	£1.20
J3240	50mm (EF) Gold	PAIR	£1.40
J46492	55mm (EF) Black	PAIR	£1.20
J46493	55mm (EF) Gold	PAIR	£1.40
J46494	65mm (EF) Black	PAIR	£1.30
J46495	65mm (EF) Gold	PAIR	£1.50
J3241	70mm (EF) Black	PAIR	£1.50
J3242	70mm (EF) Gold	PAIR	£1.65

## Pointed



Quartz Clock Hands - Euro Fitting (EF) - Pointed

- Black
- Gold
- Euro Fitting (EF)
- Aluminium
- Made in Germany

Collet Dimensions:  
 • Minute: 3.5 x 2.8mm  
 • Hour: Ø5.0mm

All measured from minute collet centre to hand tip.

The hands are generic and can be adjusted to fit. The hand collets may require slots being cut for pinching

(by using a piercing saw) and/or the collet can be shortened by filing.

Code	Description	UOM	Price
J46496	75mm (EF) Black	PAIR	£1.55
J46497	75mm (EF) Gold	PAIR	£1.85

## Serpentine



Quartz Clock Hands - Euro Fitting (EF) - Serpentine

Cousins\* = Click Website "Bulk Savings" icon for Big Discounts

- Black
- Gold
- Euro Fitting (EF)
- Aluminium
- Made in Germany

Collet Dimensions:  
 • Minute: 3.5 x 2.8mm  
 • Hour: Ø5.0mm

All measured from minute collet centre to hand tip.

The hands are generic and can be adjusted to fit. The hand collets may require slots being cut for pinching (by using a piercing saw) and/or the collet can be shortened by filing.

Cousins\* = Click Website "Bulk Savings" icon for Big Discounts

Code	Description	UOM	Price
J3246	46mm (EF) Black	PAIR	£1.10
J3247	46mm (EF) Gold	PAIR	£1.20
J3248	60mm (EF) Black	PAIR	£1.20
J3249	60mm (EF) Gold	PAIR	£1.30
H49013	61mm (EF) Black, Cousins*	PAIR	£0.95
H49014	61mm (EF) Gold, Cousins*	PAIR	£0.95
J3250	68mm (EF) Black	PAIR	£1.40
J3251	68mm (EF) Gold	PAIR	£1.65
J3252	76mm (EF) Black	PAIR	£1.50
J3253	76mm (EF) Gold	PAIR	£1.75
J3254	85mm (EF) Black	PAIR	£1.60
J3255	85mm (EF) Gold	PAIR	£1.75
H49015	85mm (EF) Black, Cousins*	PAIR	£0.95
H49016	85mm (EF) Gold, Cousins*	PAIR	£0.95
J3256	103mm (EF) Black	PAIR	£1.90
J3257	103mm (EF) Gold	PAIR	£2.10
J3258	120mm (EF) Black	PAIR	£2.50
J3259	120mm (EF) Gold	PAIR	£2.90
J46510	132mm (EF) Black	PAIR	£3.90
J46511	132mm (EF) Gold	PAIR	£4.50
J46512	160mm (EF) Black	PAIR	£4.50
J46513	160mm (EF) Gold	PAIR	£5.20

Price breaks available, see website

**PRICE PROMISE**  
**GUARANTEE**

**TODAY** SAME DAY DISPATCH

**Spade Hour (Minute, One Diamond)**



Quartz Clock Hands - Euro Fitting (EF) - Spade (Hour only)

- Black
- Gold
- Euro Fitting (EF)
- Hour Hand Spade
- Aluminium
- Made in Germany

Collet Dimensions:  
 • Minute: 3.5 x 2.8mm  
 • Hour: Ø5.0mm

All measured from minute collet centre to hand tip.

The hands are generic and can be adjusted to fit. The hand collets may require slots being cut for pinching (by using a piercing saw) and/or the collet can be shortened by filing.

Code	Description	UOM	Price
J46580	67mm (EF) Black	PAIR	£1.30
J46582	90mm (EF) Black	PAIR	£2.00
J46583	90mm (EF) Gold	PAIR	£2.30
J46584	138mm (EF) Black	PAIR	£4.30

**Spade Hour (Minute, Two Diamond)**



Quartz Clock Hands - Euro Fitting (EF) - Spade (Hour only)

- Black
- Gold
- Euro Fitting (EF)
- Hour Hand Spade
- Aluminium
- Made in Germany

Collet Dimensions:  
 • Minute: 3.5 x 2.8mm  
 • Hour: Ø5.0mm

All measured from minute collet centre to hand tip.

The hands are generic and can be adjusted to fit. The hand collets may require slots being cut for pinching (by using a piercing saw) and/or the collet can be shortened by filing.

Code	Description	UOM	Price
J38672	32mm (EF) Gold	PAIR	£1.30
J41151	50mm (EF) Black	PAIR	£1.30
J41150	50mm (EF) Gold	PAIR	£1.50
J41152	67mm (EF) Black	PAIR	£1.30
J41153	67mm (EF) Gold	PAIR	£1.50
J3264	75mm (EF) Black	PAIR	£1.30
J3265	75mm (EF) Gold	PAIR	£1.50
J3244	100mm (EF) Black	PAIR	£1.90
J3245	100mm (EF) Gold	PAIR	£2.20

**Spade Hour**



Quartz Clock Hands - Euro Fitting (EF) - Spade (Hour only)

- Black
- Gold
- Euro Fitting (EF)
- Hour Hand Spade
- Aluminium
- Made in Germany

Collet Dimensions:  
 • Minute: 3.5 x 2.8mm  
 • Hour: Ø5.0mm

All measured from minute collet centre to hand tip.

The hands are generic and can be adjusted to fit. The hand collets may require slots being cut for pinching (by using piercing sawblades) and/or the collet can be shortened by filing.

Code	Description	UOM	Price
J46516	25mm (EF) Black	PAIR	£1.30
J46517	25mm (EF) Gold	PAIR	£1.50
J46518	30mm (EF) Black	PAIR	£1.10
J46519	30mm (EF) Gold	PAIR	£1.30
J46520	32mm (EF) Black	PAIR	£1.10
J46521	32mm (EF) Gold	PAIR	£1.30
J46522	40mm (EF) Black	PAIR	£1.30
J46523	40mm (EF) Gold	PAIR	£1.50
J46524	64mm (EF) Black	PAIR	£1.35
J46525	64mm (EF) Gold	PAIR	£1.60
J46528	80mm (EF) Black	PAIR	£1.50
J46529	80mm (EF) Gold	PAIR	£1.75
J46530	82mm (EF) Black	PAIR	£1.50
J46531	82mm (EF) Gold	PAIR	£1.75
J46532	85mm (EF) Black	PAIR	£1.70
J46533	85mm (EF) Gold	PAIR	£1.95
J46534	95mm (EF) Black	PAIR	£1.90
J46535	95mm (EF) Gold	PAIR	£2.20
J46536	100mm (EF) Black	PAIR	£2.40
J46537	100mm (EF) Gold	PAIR	£2.50
J46538	105mm (EF) Black	PAIR	£2.40
J46539	105mm (EF) Gold	PAIR	£2.50

**Spade Hour**



Quartz Clock Hands - Euro Fitting (EF) - Spade (Hour only)

- Black
- Gold
- Euro Fitting (EF)
- Hour Hand Spade
- Aluminium
- Made in Germany

Collet Dimensions:  
 • Minute: 3.5 x 2.8mm  
 • Hour: Ø5.0mm

All measured from minute collet centre to hand tip.

The hands are generic and can be adjusted to fit. The hand collets may require slots being cut for pinching (by using a piercing saw) and/or the collet can be shortened by filing.

Code	Description	UOM	Price
J46540	52mm (EF) Black	PAIR	£1.30
J46541	52mm (EF) Gold	PAIR	£1.50
J46542	54mm (EF) Black	PAIR	£1.45
J46543	54mm (EF) Gold	PAIR	£1.65
J46544	64mm (EF) Black	PAIR	£1.50
J46545	64mm (EF) Gold	PAIR	£1.75
J46546	70mm (EF) Black	PAIR	£1.60
J46547	70mm (EF) Gold	PAIR	£1.85
J46548	75mm (EF) Black	PAIR	£1.70
J46549	75mm (EF) Gold	PAIR	£1.95
J46550	80mm (EF) Black	PAIR	£1.90
J46551	80mm (EF) Gold	PAIR	£2.20
J46552	85mm (EF) Black	PAIR	£1.90
J46553	85mm (EF) Gold	PAIR	£2.20
J46554	98mm (EF) Black	PAIR	£2.50
J46555	98mm (EF) Gold	PAIR	£2.85
J46556	110mm (EF) Black	PAIR	£3.00
J46557	110mm (EF) Gold	PAIR	£3.50
J46558	120mm (EF) Black	PAIR	£4.50

**Spade Hour & Minute**



Quartz Clock Hands - Euro Fitting (EF) - Spade (H&M)  
 Cousins\* = Click Website "Bulk Savings" icon for Big Discounts

- Black
- Gold

**Clock Batteries**

**See Page: 8**

- Euro Fitting (EF)
- Both Hands Spade
- Aluminium
- Made in Germany

Collet Dimensions:  
 • Minute: 3.5 x 2.8mm  
 • Hour: Ø5.0mm

All measured from minute collet centre to hand tip.

The hands are generic and can be adjusted to fit. The hand collets may require slots being cut for pinching (by using a piercing saw) and/or the collet can be shortened by filing.

Cousins\* = Click Website "Bulk Savings" icon for Big Discounts

Code	Description	UOM	Price
J3290	32mm (EF) Black	PAIR	£1.70
J3291	32mm (EF) Gold	PAIR	£1.95
J3266	41mm (EF) Black	PAIR	£1.20
J3267	41mm (EF) Gold	PAIR	£1.50
H49021	50mm (EF) Black, Cousins*	PAIR	£0.95
H49022	50mm (EF) Gold, Cousins*	PAIR	£0.95
J46514	60mm (EF) Black	PAIR	£1.50
H49023	72mm (EF) Black, Cousins*	PAIR	£0.95
H49024	72mm (EF) Gold, Cousins*	PAIR	£0.95
J3293	73mm (EF) Gold	PAIR	£1.50
J3268	75mm (EF) Black	PAIR	£1.50
J3270	85mm (EF) Black	PAIR	£1.60
J3271	85mm (EF) Gold	PAIR	£2.00
H49017	90mm (EF) Black, Cousins*	EACH	£0.95
H49018	90mm (EF) Gold, Cousins*	PAIR	£0.95
H49019	117mm (EF) Black, Cousins*	PAIR	£0.95
H49020	117mm (EF) Gold, Cousins*	PAIR	£0.95

Price breaks available, see website

## Vienna Regulator



Quartz Clock Hands - Euro Fitting (EF) - Vienna Regulator - Superior Quality

- Black
- Euro Fitting (EF)
- Aluminium
- Superior Quality
- Made in Germany

Collet Dimensions:  
 • Minute: 3.5 x 2.8mm  
 • Hour: Ø5.0mm

All measured from minute collet centre to hand tip.

The hands are generic and can be adjusted to fit. The hand collets may require slots being cut for pinching (by using a piercing saw) and/or the collet can be shortened by filing.

Code	Description	UOM	Price
H37745	65mm (A) Black Vienna, Superior Quality	PAIR	£8.25
H37748	88mm (A) Black Vienna, Superior Quality	PAIR	£4.95

## Clock Batteries



See Page: 8

## NON EURO FITTING (NEF) HANDS

Non Euroshaft (NEF) or push fit quartz hands are suitable for our UTS & Seiko NEF quartz clock movements.

Non Euro Fitting (NEF) Hand Collet Dimensions:

- Minute: Ø3.50mm
- Hour: Ø5.50mm

All clock hands are measured from collet centre to tip of minute hand.

Non Euro Fitting (NEF) Movement Collet Dimensions:

- UTS movements: Minute = Ø3.50mm, Hour = Ø5.00mm
- Seiko movements: Minute = Ø3.50mm, Hour = Ø5.50mm

The hands are generic and can be adjusted to fit. The hand collets may require slots being cut for pinching (by using a piercing saw) and/or the collet can be shortened by filing.

## Set & Replacements



Quartz Clock Hands - Non Euro Fitting (NEF) - Set & Replacements

Collet Dimensions:  
 • Minute: Ø3.50mm  
 • Hour: Ø5.50mm

Box Set Contains:  
 • 12 Pairs  
 • 12 Centre Seconds  
 • Non Euro Fitting (NEF)

Hour & Minute Hands in Black  
 • H20306A – Black 91mm 2 Pair  
 • H20306B – Black 107mm 2 Pair  
 • H20306C – Black 108mm 2 Pair  
 • H20306D – Black 132mm 2 Pair  
 • H20306E – Black 135mm 2 Pair  
 • H20306F – Black 170mm 2 Pair

Center Seconds Hands  
 • H20305G – Gold 128mm 6 Pieces  
 • H20305H – Silver 128mm 2 Pieces  
 • H20305J – Black 128mm 2 Pieces  
 • H20305K – Red 128mm 2 Pieces

All measured from minute collet centre to hand tip. The hands are generic and can be adjusted to fit. The hand collets may require slots being cut for pinching (by using a piercing saw) and/or the collet can be shortened by filing.

Code	Description	UOM	Price
H20306	Set of NEF Quartz Clock Hands	EACH	£11.90
H20306A	91mm (NEF) Black, Fancy	EACH	£0.75
H20306B	107mm (NEF) Black, Spear	EACH	£0.75
H20306C	108mm (NEF) Black, Baton	EACH	£0.75
H20306D	132mm (NEF) Black, Spade	EACH	£0.75
H20306E	135mm (NEF) Black, Bold	EACH	£0.75
H20306F	170mm (NEF) Black, Pointed	EACH	£0.75

Price breaks available, see website

## 225mm (XL) High Torque



Quartz Clock Hands - Non Euro Fitting (NEF) - Baton - XL (High Torque)

- Black
- Non Euro Fitting (NEF)
- Minute length 225mm
- Aluminium
- Made in Germany

Collet Dimensions:  
 • Minute: Ø3.50mm  
 • Hour: Ø5.50mm

All measured from minute collet centre to hand tip.

The hands are generic and can be adjusted to fit. The hand collets may require slots being cut for pinching (by using a piercing saw) and/or the collet can be shortened by filing.

Code	Description	UOM	Price
H42152	Baton 225mm (NEF) Black, XL	PAIR	£7.95

## Baton with Tail



Quartz Clock Hands - Non Euro Fitting (NEF) - Baton

- Black
- Non Euro Fitting (NEF)
- All measured from minute collet centre to hand tip
- Aluminium
- Made in China

Collet Dimensions:  
 • Minute: Ø3.50mm  
 • Hour: Ø5.50mm

The hands are generic and can be adjusted to fit. The hand collets may require slots being cut for pinching (by using a piercing saw) and/or the collet can be shortened by filing.

Code	Description	UOM	Price
H45974	78mm (NEF) Black	PAIR	£0.50
H45976	93mm (NEF) Black	PAIR	£0.50
H45977	100mm (NEF) Black	PAIR	£0.50
H45975	108mm (NEF) Black	PAIR	£0.50
H45978	120mm (NEF) Black	PAIR	£0.50
H45979	161mm (NEF) Black	PAIR	£0.50

Price breaks available, see website

**Baton without Tail**



Quartz Clock Hands – Non Euro Fitting (NEF) - Baton without Tail

- Black
- Non Euro Fitting (NEF)
- All measured from minute collet centre to hand tip
- Aluminium
- Made in China

Collet Dimensions:

- Minute: Ø3.50mm
- Hour: Ø5.50mm

The hands are generic and can be adjusted to fit. The hand collets may require slots being cut for pinching (by using a piercing saw) and/or the collet can be shortened by filing.

Code	Description	UOM	Price
H47641	35mm (NEF) Black	PAIR	£0.50
H47639	64mm (NEF) Black	PAIR	£0.50
H47643	77mm (NEF) Black	PAIR	£0.50
H47644	88mm (NEF) Black	PAIR	£0.50
H47640	96mm (NEF) Black	PAIR	£0.50
H47638	108mm (NEF) Black	PAIR	£0.50
H47642	166mm (NEF) Black	PAIR	£0.50
Price breaks available, see website			

**Crescent**



Quartz Clock Hands – Non Euro Fitting (NEF) - Crescent

- Black
- Non Euro Fitting (NEF)
- All measured from minute collet centre to hand tip
- Aluminium
- Made in China

Collet Dimensions:

- Minute: Ø3.50mm
- Hour: Ø5.50mm

The hands are generic and can be adjusted to fit. The hand collets may require slots being cut for pinching (by using a piercing saw) and/or the collet can be shortened by filing.

Code	Description	UOM	Price
H47635	83mm (NEF) Black	PAIR	£0.50
Price breaks available, see website			

**Dauphine Style**



Quartz Clock Hands – Non Euro Fitting (NEF) - Dauphine Style

- Black
- Non Euro Fitting (NEF)
- All measured from minute collet centre to hand tip
- Raised centre (\* = non raised centre, flat profile)
- Aluminium
- Made in China

Collet Dimensions:

- Minute: Ø3.50mm
- Hour: Ø5.50mm

The hands are generic and can be adjusted to fit. The hand collets may require slots being cut for pinching (by using a piercing saw) and/or the collet can be shortened by filing.

Code	Description	UOM	Price
H47634	68mm (NEF) Black	PAIR	£0.50
H47633	83mm (NEF) Black	PAIR	£0.50
H47630	98mm (NEF) Black*	PAIR	£0.50
H47631	108mm (NEF) Black	PAIR	£0.50
H47632	120mm (NEF) Black	PAIR	£0.50
Price breaks available, see website			

**Fleur De Lys**



Quartz Clock Hands – Non Euro Fitting (NEF) - Fleur De Lys

- Black
- Non Euro Fitting (NEF)
- All measured from minute collet centre to hand tip
- Aluminium
- Made in China

Collet Dimensions:

- Minute: Ø3.50mm
- Hour: Ø5.50mm

The hands are generic and can be adjusted to fit. The hand collets may require slots being cut for pinching (by using a piercing saw) and/or the collet can be shortened by filing.

Code	Description	UOM	Price
H47637	95mm (NEF) Black	PAIR	£0.50
Price breaks available, see website			

**Moon**

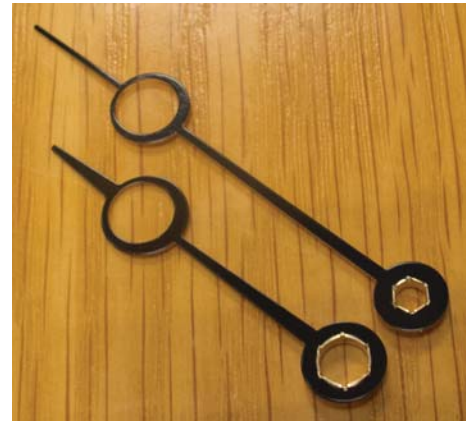

Quartz Clock Hands – Non Euro Fitting (NEF) - Moon

- Black
- Non Euro Fitting (NEF)
- All measured from minute collet centre to hand tip
- Aluminium
- Made in China

Collet Dimensions:

- Minute: Ø3.50mm
- Hour: Ø5.50mm

The hands are generic and can be adjusted to fit. The hand collets may require slots being cut for pinching (by using a piercing saw) and/or the collet can be shortened by filing.

Code	Description	UOM	Price
H47636	62mm (NEF) Black	PAIR	£0.50
Price breaks available, see website			

**Serpentine**



Quartz Clock Hands – Non Euro Fitting (NEF) - Serpentine

- Black
- Non Euro Fitting (NEF)
- All measured from minute collet centre to hand tip
- Aluminium
- Made in China

Collet Dimensions:

- Minute: Ø3.50mm
- Hour: Ø5.50mm

The hands are generic and can be adjusted to fit. The hand collets may require slots being cut for pinching (by using a piercing saw) and/or the collet can be shortened by filing.

Code	Description	UOM	Price
H45986	56mm (NEF) Black	PAIR	£0.50
H45985	61mm (NEF) Black	PAIR	£0.50
H45987	76mm (NEF) Black	PAIR	£0.50
H45988	97mm (NEF) Black	PAIR	£0.50
H45989	106mm (NEF) Black	PAIR	£0.50
Price breaks available, see website			



## Spade Hour



Quartz Clock Hands – Non Euro Fitting (NEF) - Spade Hour

- Black
- Non Euro Fitting (NEF)
- All measured from minute collet centre to hand tip
- Aluminium
- Made in China

Collet Dimensions:

- Minute: Ø3.50mm
- Hour: Ø5.50mm

The hands are generic and can be adjusted to fit. The hand collets may require slots being cut for pinching (by using a piercing saw) and/or the collet can be shortened by filing.

Code	Description	UOM	Price
H46154	25.5mm (NEF) Black	PAIR	£0.50
H46155	72mm (NEF) Black	PAIR	£0.50
H46156	132mm (NEF) Black	PAIR	£0.50

Price breaks available, see website

## Spade Hour & Minute



Quartz Clock Hands – Non Euro Fitting (NEF) - Spade Hour & Minute

- Black
- Non Euro Fitting (NEF)
- All measured from minute collet centre to hand tip
- Aluminium
- Made in China

Collet Dimensions:

- Minute: Ø3.50mm
- Hour: Ø5.50mm

The hands are generic and can be adjusted to fit. The hand collets may require slots being cut for pinching (by using a piercing saw) and/or the collet can be shortened by filing.

Code	Description	UOM	Price
H45980	34mm (NEF) Black	PAIR	£0.50

H45981	50mm (NEF) Black	PAIR	£0.50
H45982	72mm (NEF) Black	PAIR	£0.50
H45983	90mm (NEF) Black	PAIR	£0.50
H45984	117mm (NEF) Black	PAIR	£0.50

Price breaks available, see website

## HAND COLLETS (QUARTZ)

### Quartz Euroshaft, Hour Collets

Quartz Euroshaft Clock Hour Hand Collets



- Brass
- Ø5mm Collet
- Fits standard UTS Euroshaft
- For rivet fitment
- 10 pieces

Code	Description	UOM	Price
C8997	Quartz Euroshaft Hour Collets	PACK*10	£2.50

### Quartz Euroshaft, Minute Collets

Quartz Euroshaft Clock Hour Hand Collets



- Brass
- Ø6.5mm Flat Collet
- For standard UTS Euroshaft
- For minute hand fitting
- 25 pieces

Code	Description	UOM	Price
C5329	Quartz Euroshaft Minute Collets	PACK*25	£3.95

## HAND NUTS & WASHERS

### Clock Repairers Handy Travel Fixing Kit



Clock Repairers Handy Travel Box Assorted Parts

Excellent utility box for clock repairers who do not want to buy each separate

- Hand Nuts
- Screws
- Hand Collets
- Bushes
- C Clips
- Hinges
- Dial Grommets
- 150 pieces

Code	Description	UOM	Price
A32032	Clock Repairers Travel Box Assorted Parts	PACK*150	£7.95

## Assorted Clock Nuts



General Clock Nuts - Assorted

- Brass or Steel
- General Purpose
- Various Sizes
- 100 Pieces

Code	Description	UOM	Price
A4954	Brass Nuts Assorted	PACK*100	£2.95
A4954A	Steel Nuts Assorted	PACK*100	£2.95

## Black Forest & Cuckoo Hand Nuts

Clock Hand Nuts - Black Forest & Cuckoo

To hold clock minute hands in position for general use including Cuckoo & Black Forest Clocks.



- Brass
- Threaded screw on nuts
- Assorted
- 25 pieces
- Made in Germany

Code	Description	UOM	Price
H8943	Black Forest Clock Hand Nuts	PACK*25	£12.95

## Kitchen & Wall Clock Hand Nuts

Clock Hand Nuts - Wall & Kitchen

To hold clock minute hands in position for use on wall & kitchen clock also Hermle, Mains Synchronous & General clocks.



- Brass & Steel
- Minute hand nuts
- Threaded screw on nuts
- Assorted

Code	Description	UOM	Price
C31283	Minute Hand Nuts, Hermle	PACK*12	£3.25
A32031	Minute Hand Nuts, Cousins	PACK*12	£2.95
A6604	Minute Hand Nuts, Bergeon	PACK*24	£32.60

## Washers, Split Circlip



Split Circlip (C- Clip) Clock Washers

- Clock Hand Fitting
- Also useful on strike mechanism posts
- Assorted
- Various Diameters, Shapes & types

Code	Description	UOM	Price
W31282	Assorted Pack, Non E.U	PACK*100	£2.20

**Washers, Square & Round Hole, Black/Blue**



Clock Hand Washers, Black/Blue

- Square & Round Hole
- Various Diameters
- Also useful on strike mechanism posts
- Domed Black/Blue
- 144 pieces

Code	Description	UOM	Price
W6027	Blued Clock Hand Washers	PACK*144	£4.95

**Washers, Square & Round Hole, Brass**



Clock Hand Washers, Brass

- Square & Round Hole
- Various Diameters
- Also useful on strike mechanism posts
- Domed Brass

Code	Description	UOM	Price
W1830	Square & Round Hole Washers	PACK*144	£4.30
A31281	Square & Round Hole Washers	PACK*100	£2.20
A31279	Square Hole Washers	PACK*100	£2.20
A31280	Round Hole Washers	PACK*100	£2.20

**Washers, General for Clocks**



General Clock Washers

General assortment for Clocks and many other useful applications.

- Small and medium
- Nickel or brass
- 100 pieces

Code	Description	UOM	Price
W39685	Brass Clock Washers	PACK*100	£2.50
W8665	Nickle Clock Washers	PACK*100	£3.15

**HAND SETTERS & KEYS**

**Alarm Clock Hand Setters**



Alarm Clock Hand Setters - Assorted

Very Practical, a "Must" for every clock workshop

- Various sizes and shapes
- Nickel Finish
- 100 pieces

Code	Description	UOM	Price
S12444	Alarm Clock Hand Setters	PACK*100	£13.95

**Alarm Clock Winding Keys**



Alarm Clock Winding Keys - Assorted

Very Practical, a "Must" for every clock workshop

- Very handy & useful
- Various sizes and shapes
- Steel
- 100 pieces

Code	Description	UOM	Price
K32017	Alarm Clock Winding Keys	PACK*100	£14.95

**Clock Let Down Tool With 6 Key Shafts**



See Page: 919

**KEYS, CLOCK & POCKET WATCH**

**CLOCK KEYS IMPERIAL, UK MADE**

Imperial Sizes - Made in UK

Clock Keys UK Sizes Imperial to Metric. (Numbering system for Indian made keys does not equal UK imperial number system).

- UK Imperial Sizes:
- 000 (3/0) = Metric 2.00mm
  - 00 (2/0) = Metric 2.20mm
  - 0 (1/0) = Metric 2.40mm
  - 1 = Metric 2.60mm
  - 2 = Metric 2.80mm
  - 3 = Metric 3.00mm
  - 4 = Metric 3.20mm
  - 5 = Metric 3.40mm
  - 6 = Metric 3.60mm
  - 7 = Metric 3.80mm
  - 8 = Metric 4.00mm
  - 9 = Metric 4.20mm
  - 10 = Metric 4.40mm
  - 11 = Metric 4.60mm
  - 12 = Metric 4.80mm
  - 13 = Metric 5.00mm
  - 14 = Metric 5.20mm
  - 15 = Metric 5.40mm
  - 16 = Metric 5.60mm
  - 17 = Metric 5.80mm
  - 18 = Metric 6.00mm
  - 19 = Metric 6.20mm
  - 20 = Metric 6.40mm
  - 21 = Metric 6.60mm

Best Quality UK Made Clock Keys

**Antique Bow Style**

Imperial Sizes - Made in France

- Antique Finish
- Bow Style Handle
- High Quality
- Steel
- French Made
- Imperial UK Sizing (0 to 12)
- Millimetre size in brackets



(Numbering system for Indian made keys does not equal UK imperial number system)

Code	Description	UOM	Price
K5018	No.0 (1/0) (2.40mm) Key	EACH	£7.50
K5019	No.1 (2.60mm) Key	EACH	£7.50
K5020	No.2 (2.80mm) Key	EACH	£7.50
K5021	No.3 (3.00mm) Key	EACH	£7.50
K5022	No.4 (3.20mm) Key	EACH	£7.50
K5023	No.5 (3.40mm) Key	EACH	£7.50
K5024	No.6 (3.60mm) Key	EACH	£7.50
K5025	No.7 (3.80mm) Key	EACH	£7.50
K5026	No.8 (4.00mm) Key	EACH	£7.50
K5027	No.9 (4.20mm) Key	EACH	£7.50
K5028	No.10 (4.40mm) Key	EACH	£7.50
K5029	No.11 (4.60mm) Key	EACH	£7.50
K5030	No.12 (4.80mm) Key	EACH	£7.50

Price breaks available, see website

www. Online Discounts

**Crank Keys, Longcase**

Imperial Sizes - Made in UK

- Traditional Style
- High Quality
- Brass / Steel
- Hardwood Handle
- Imperial UK Sizing (8 to 21)
- Millimetre size in brackets
- Made in UK



(Numbering system for Indian made keys does not equal UK imperial number system)

Code	Description	UOM	Price
K3067	No.8 (4.00mm) Key	EACH	£10.25
K3068	No.9 (4.20mm) Key	EACH	£10.25
K3069	No.10 (4.40mm) Key	EACH	£10.25
K3070	No.11 (4.60mm) Key	EACH	£10.25
K3071	No.12 (4.80mm) Key	EACH	£10.25
K3072	No.13 (5.00mm) Key	EACH	£10.25
K3073	No.14 (5.20mm) Key	EACH	£10.25
K3074	No.15 (5.40mm) Key	EACH	£10.25
K3075	No.16 (5.60mm) Key	EACH	£10.25
K3076	No.17 (5.80mm) Key	EACH	£10.25
K3077	No.18 (6.00mm) Key	EACH	£10.25
K3078	No.19 (6.20mm) Key	EACH	£10.25
K3079	No.20 (6.40mm) Key	EACH	£10.25
K3080	No.21 (6.60mm) Key	EACH	£10.25

Price breaks available, see website

**Crank Keys, Vienna Regulator**

Imperial Sizes - Made in UK

- Traditional Style
- High Quality
- Brass / Steel
- Imperial UK Sizing (00 to 10)
- Millimetre size in brackets
- Made in UK



(Numbering system for Indian made keys does not equal UK imperial number system)

Code	Description	UOM	Price
K3081	No.00 (2/0) (2.20mm) Key	EACH	£2.85
K3082	No.0 (1/0) (2.40mm) Key	EACH	£2.85
K3083	No.1 (2.60mm) Key	EACH	£2.85
K3084	No.2 (2.80mm) Key	EACH	£2.85
K3085	No.3 (3.00mm) Key	EACH	£2.85
K3086	No.4 (3.20mm) Key	EACH	£2.85
K3087	No.5 (3.40mm) Key	EACH	£2.85
K3088	No.6 (3.60mm) Key	EACH	£2.85
K3089	No.7 (3.80mm) Key	EACH	£2.85
K3090	No.8 (4.00mm) Key	EACH	£2.85
K3091	No.9 (4.20mm) Key	EACH	£2.85
K3092	No.10 (4.40mm) Key	EACH	£2.85

**Double Ended, Ansonia**

Imperial Sizes - Made in UK

Doubled ended with a second 1.75mm pipe fitted for the time adjustment on Ansonia clocks.

- Ansonia Double Ended
- High Quality
- Brass
- Second Pipe 1.75mm
- Imperial UK Sizing (4 to 12)
- Millimetre size in brackets
- Made in UK



(Numbering system for Indian made keys does not equal UK imperial number system)

Code	Description	UOM	Price
K3053	No.4 (3.20mm) Key	EACH	£3.60

K3054	No.5 (3.40mm) Key	EACH	£3.60
K3055	No.6 (3.60mm) Key	EACH	£3.60
K3056	No.7 (3.80mm) Key	EACH	£3.60
K3057	No.8 (4.00mm) Key	EACH	£3.60
K3058	No.9 (4.20mm) Key	EACH	£3.60
K3059	No.10 (4.40mm) Key	EACH	£3.60
K3060	No.11 (4.60mm) Key	EACH	£3.60
K3061	No.12 (4.80mm) Key	EACH	£3.60

**Double Ended, Carriage**

Imperial Sizes - Made in UK

Doubled ended with a second (1.75mm/2.00mm) pipe fitted for the time adjustment on carriage clocks.

- Carriage Clock, Double Ended
- High Quality
- Brass
- Second Pipe 1.75mm (sizes 00 to 3)
- Second Pipe 2.00mm (sizes 4 to 10)
- Imperial UK Sizing (000 to 10)
- Millimetre size in brackets
- Made in UK



(Numbering system for Indian made keys does not equal UK imperial number system)

Code	Description	UOM	Price
K3041	No.00 (2/0) (2.20mm) Key	EACH	£3.95
K3042	No.0 (1/0) (2.40mm) Key	EACH	£3.95
K3043	No.1 (2.60mm) Key	EACH	£3.95
K3044	No.2 (2.80mm) Key	EACH	£3.95
K3045	No.3 (3.00mm) Key	EACH	£3.95
K3046	No.4 (3.20mm) Key	EACH	£3.95
K3047	No.5 (3.40mm) Key	EACH	£3.95
K3048	No.6 (3.60mm) Key	EACH	£3.95
K3049	No.7 (3.80mm) Key	EACH	£3.95
K3051	No.9 (4.20mm) Key	EACH	£3.95
K3052	No.10 (4.40mm) Key	EACH	£3.95

**Star Keys, Imperial**

Imperial Sizes - Made in UK

Strong bench keys with pinned shanks on a solid hub.

- Traditional Style
- High Quality
- Brass
- Imperial UK Sizing (5 ranges)
- Made in UK



(Numbering system for Indian made keys does not equal UK imperial number system)

Code	Description	UOM	Price
K3062	4, 6, 8 & 10 Star Key	EACH	£9.90
K3064	5, 7, 9 & 11 Star Key	EACH	£9.90
K3063	6, 8, 10 & 12 Star Key	EACH	£9.90
K3066	7, 9, 11 & 13 Star Key	EACH	£9.90
K3065	8, 10, 12 & 14 Star Key	EACH	£9.90

Price breaks available, see website

**Clock Key Gauge**

See Page 926



**Traditional, Brass**

Imperial Sizes - Made in UK

- Traditional Style
- High Quality
- Brass
- Imperial UK Sizing (0 to 12)
- Millimetre size in brackets
- Made in UK



(Numbering system for Indian made keys does not equal UK imperial number system)

Code	Description	UOM	Price
K3022	No.00 (2/0) (2.20mm) Key	EACH	£3.25
K3023	No.0 (1/0) (2.40mm) Key	EACH	£3.25
K3024	No.1 (2.60mm) Key	EACH	£3.25
K3025	No.2 (2.80mm) Key	EACH	£3.25
K3026	No.3 (3.00mm) Key	EACH	£3.25
K3027	No.4 (3.20mm) Key	EACH	£3.25
K3028	No.5 (3.40mm) Key	EACH	£3.25
K3029	No.6 (3.60mm) Key	EACH	£3.25
K3030	No.7 (3.80mm) Key	EACH	£3.25
K3031	No.8 (4.00mm) Key	EACH	£3.25
K3032	No.9 (4.20mm) Key	EACH	£3.25
K3033	No.10 (4.40mm) Key	EACH	£3.25
K3034	No.11 (4.60mm) Key	EACH	£3.25
K3035	No.12 (4.80mm) Key	EACH	£3.25
K3036	No.13 (5.00mm) Key	EACH	£3.25
K3037	No.14 (5.20mm) Key	EACH	£3.25
K3038	No.15 (5.40mm) Key	EACH	£3.25
K3039	No.16 (5.60mm) Key	EACH	£3.25

Price breaks available, see website

**Traditional, Steel**

Imperial Sizes - Made in UK

- Traditional Style
- High Quality
- Steel
- Imperial UK Sizing (0 to 20)
- Millimetre size in brackets
- Made in UK



(Numbering system for Indian made keys does not equal UK imperial number system)

Code	Description	UOM	Price
K3001	No.0 (1/0) (2.40mm) Key	EACH	£2.90
K3002	No.1 (2.60mm) Key	EACH	£2.90
K3003	No.2 (2.80mm) Key	EACH	£2.90
K3004	No.3 (3.00mm) Key	EACH	£2.90
K3005	No.4 (3.20mm) Key	EACH	£2.90
K3006	No.5 (3.40mm) Key	EACH	£2.90
K3007	No.6 (3.60mm) Key	EACH	£2.90
K3008	No.7 (3.80mm) Key	EACH	£2.90
K3009	No.8 (4.00mm) Key	EACH	£2.90
K3010	No.9 (4.20mm) Key	EACH	£2.90
K3011	No.10 (4.40mm) Key	EACH	£2.90
K3012	No.11 (4.60mm) Key	EACH	£2.90
K3013	No.12 (4.80mm) Key	EACH	£2.90
K3014	No.13 (5.00mm) Key	EACH	£2.90
K3015	No.14 (5.20mm) Key	EACH	£2.90
K3016	No.15 (5.40mm) Key	EACH	£2.90
K3017	No.16 (5.60mm) Key	EACH	£2.90
K3018	No.17 (5.80mm) Key	EACH	£2.90
K3019	No.18 (6.00mm) Key	EACH	£3.25
K3020	No.19 (6.20mm) Key	EACH	£3.25
K3021	No.20 (6.40mm) Key	EACH	£3.25

Price breaks available, see website

**COUSINSUK PRICE PROMISE**



## CLOCK KEYS METRIC, UK MADE

### Crank Key, Longcase

Metric Sizes - Made in UK

- Traditional Style
- High Quality
- Brass / Steel
- Hardwood Handle
- Metric Sizing (4.00mm to 7.00mm)
- Made in Great Britain



Code	Description	UOM	Price
K4890	4.00mm Key	EACH	£10.25
K4891	4.25mm Key	EACH	£10.25
K4892	4.50mm Key	EACH	£10.25
K4893	4.75mm Key	EACH	£10.25
K4894	5.00mm Key	EACH	£10.25
K4895	5.25mm Key	EACH	£10.25
K4896	5.50mm Key	EACH	£10.25
K4897	5.75mm Key	EACH	£10.25
K4898	6.00mm Key	EACH	£10.25
K4899	6.25mm Key	EACH	£10.25
K4900	6.50mm Key	EACH	£10.25
K4901	6.75mm Key	EACH	£10.25
K4902	7.00mm Key	EACH	£10.25

Price breaks available, see website

### Double Ended, Carriage

Metric Sizes - Made in UK

Doubled ended with a second (2.00mm) pipe fitted for the time adjustment on carriage clocks.

- Carriage Clock, Double Ended
- Antique Style
- High Quality
- Brass
- Second Pipe 2.00mm
- Metric Sizing (3.00mm to 4.75mm)
- Made in Great Britain



Code	Description	UOM	Price
K9616	3.00mm Key	EACH	£12.75
K9617	3.25mm Key	EACH	£12.75
K9618	3.50mm Key	EACH	£12.75
K9619	3.75mm Key	EACH	£12.75
K9620	4.00mm Key	EACH	£12.75
K9621	4.25mm Key	EACH	£12.75
K9622	4.50mm Key	EACH	£12.75
K9623	4.75mm Key	EACH	£12.75

Price breaks available, see website

### Star Keys

Metric Sizes - Made in UK

Strong bench keys with pinned shanks on a solid hub.

- Traditional Style
- High Quality
- Brass
- Metric Sizing (4 ranges)
- Made in Great Britain



Code	Description	UOM	Price
K4886	3.00, 3.50, 4.00 & 4.50mm Key	EACH	£9.90

K4887	3.25, 3.75, 4.25 & 4.75mm Key	EACH	£9.90
K4888	3.50, 4.00, 4.50 & 5.00mm Key	EACH	£9.90
K4889	3.75, 4.25, 4.75 & 5.25mm Key	EACH	£9.90

Price breaks available, see website

### Traditional, Brass

Metric Sizes - Made in UK

- Traditional Style
- High Quality
- Brass
- Metric Sizing (2.00mm to 6.00mm)
- Made in Great Britain



Code	Description	UOM	Price
K4869	2.00mm Key	EACH	£3.25
K4870	2.25mm Key	EACH	£3.25
K4871	2.50mm Key	EACH	£3.25
K4872	2.75mm Key	EACH	£3.25
K4873	3.00mm Key	EACH	£3.25
K4874	3.25mm Key	EACH	£3.25
K4875	3.50mm Key	EACH	£3.25
K4876	3.75mm Key	EACH	£3.25
K4877	4.00mm Key	EACH	£3.25
K4878	4.25mm Key	EACH	£3.25
K4879	4.50mm Key	EACH	£3.25
K4880	4.75mm Key	EACH	£3.25
K4881	5.00mm Key	EACH	£3.25
K4882	5.25mm Key	EACH	£3.25
K4883	5.50mm Key	EACH	£3.25
K4884	5.75mm Key	EACH	£3.25
K4885	6.00mm Key	EACH	£3.25

Price breaks available, see website

### Traditional, Steel

Metric Sizes - Made in UK

- Traditional Style
- High Quality
- Steel
- Metric Sizing (2.25mm to 7.00mm)
- Made in Great Britain



Code	Description	UOM	Price
K4849	2.25mm Key	EACH	£2.90
K4850	2.50mm Key	EACH	£2.90
K4851	2.75mm Key	EACH	£2.90
K4852	3.00mm Key	EACH	£2.90
K4853	3.25mm Key	EACH	£2.90
K4854	3.50mm Key	EACH	£2.90
K4855	3.75mm Key	EACH	£2.90
K4856	4.00mm Key	EACH	£2.90
K4857	4.25mm Key	EACH	£2.90
K4858	4.50mm Key	EACH	£2.90
K4859	4.75mm Key	EACH	£2.90
K4860	5.00mm Key	EACH	£2.90
K4861	5.25mm Key	EACH	£3.25
K4862	5.50mm Key	EACH	£3.25
K4863	5.75mm Key	EACH	£3.25
K4864	6.00mm Key	EACH	£3.25
K4865	6.25mm Key	EACH	£3.25
K4866	6.50mm Key	EACH	£3.25
K4867	6.75mm Key	EACH	£3.25
K4868	7.00mm Key	EACH	£3.25

Price breaks available, see website

## CLOCK KEYS, INDIAN MADE

Indian Sizes (not imperial) - Made in India

Clock Keys Indian Sizes to Metric. (UK number system does not equal Indian imperial number system)

- Indian Sizes:
- 000 (3/0) = Metric 1.75mm
  - 00 (2/0) = Metric 2.20mm
  - 0 (1/0) = Metric 2.40mm
  - 1 = Metric 2.50mm
  - 2 = Metric 2.75mm
  - 3 = Metric 3.00mm
  - 4 = Metric 3.25mm
  - 5 = Metric 3.50mm
  - 6 = Metric 3.75mm
  - 7 = Metric 4.00mm
  - 8 = Metric 4.25mm
  - 9 = Metric 4.50mm
  - 10 = Metric 4.75mm
  - 11 = Metric 5.00mm
  - 12 = Metric 5.25mm
  - 13 = Metric 5.50mm
  - 14 = Metric 5.75mm
  - 15 = Metric 6.00mm

### Assorted Popular Keys

### Clock Key Brass & Steel Assortment



Indian Sizes (not imperial) - Made in India

- 13 popular keys
- Brass Sizes: 5, 6, 7, 8 & 9
- Steel Sizes: 4, 5, 6 & 7
- Steel Double Ended Sizes: 4, 5, 6 & 7 (small Ø1.95mm)
- Value for Money

Code	Description	UOM	Price
K32015	Clock Key Brass & Steel Assortment	PACK*13	£11.95



**Clock Key Gauge**

**See Page 926**

### Clock Key Brass & Steel Assortment



Indian Sizes (not imperial) - Made in India

- 47 popular keys
- 13 Brass Sizes: 3 to 15
- 7 Steel Single End Sizes: 2 to 8
- 8 Steel Double Ended Sizes: 4 to 7 (small Ø1.95mm)
- 14 Pocket Watch Keys: Sizes 00 to 12
- 5 Brass Travel Clock Double Keys: 4 to 8 (small Ø1.75mm)
- Value for Money

Code	Description	UOM	Price
K32016	Clock Key Brass & Steel Assortment	PACK*47	£35.00

### Crank Keys, French Clock

Indian Sizes (not imperial) - Made in India

- French Clock Style
- Steel
- Hardwood Handle
- Indian Made
- Indian (not UK) Sizing (9 to 16)



(Numbering system for Indian made keys does not equal UK imperial number system)

Code	Description	UOM	Price
K22027	No.9 (4.50mm) Key	EACH	£3.65
K22028	No.10 (4.75mm) Key	EACH	£3.65
K22029	No.11 (5.00mm) Key	EACH	£3.65
K22030	No.12 (5.25mm) Key	EACH	£3.65
K22031	No.14 (5.75mm) Key	EACH	£3.65
K22032	No.16 (6.25mm) Key	EACH	£3.65

Price breaks available, see website

### Crank Keys, Longcase, Modern



Indian Sizes (not imperial) - Made in India

- Modern Style
- Brass
- Hardwood Handle
- Indian Made
- Indian (not UK) Sizing (7 & 8)

(Numbering system for Indian made keys does not equal UK imperial number system)

Code	Description	UOM	Price
K22017	No.7 (4.00mm) Key	EACH	£4.85
K22018	No.8 (4.25mm) Key	EACH	£4.85

Price breaks available, see website

### Crank Keys, Longcase, Traditional

Indian Sizes (not imperial) - Made in India

- Traditional Style
- Brass
- Hardwood Handle
- Indian Made
- Indian (not UK) Sizing (9 to 16)



(Numbering system for Indian made keys does not equal UK imperial number system)

Code	Description	UOM	Price
K22019	No.9 (4.50mm) Key	EACH	£3.95
K22020	No.10 (4.75mm) Key	EACH	£3.95
K22021	No.11 (5.00mm) Key	EACH	£3.95
K22022	No.12 (5.25mm) Key	EACH	£3.95
K22023	No.13 (5.50mm) Key	EACH	£3.95
K22024	No.14 (5.75mm) Key	EACH	£3.95
K22025	No.15 (6.00mm) Key	EACH	£3.95
K22026	No.16 (6.25mm) Key	EACH	£4.35

Price breaks available, see website

### Crank Keys, Standard

Indian Sizes (not imperial) - Made in India

- Standard Style
- Brass / Steel
- Hardwood Handle
- Indian Made
- Indian (not UK) Sizing (0 to 13)



(Numbering system for Indian made keys does not equal UK imperial number system)

Code	Description	UOM	Price
K22112	No.0 (1/0) (2.25mm) Key	EACH	£2.20
K22113	No.1 (2.50mm) Key	EACH	£2.20
K22114	No.2 (2.75mm) Key	EACH	£2.20
K22115	No.3 (3.00mm) Key	EACH	£2.20
K22116	No.4 (3.25mm) Key	EACH	£2.20
K22117	No.5 (3.50mm) Key	EACH	£2.20
K22118	No.6 (3.75mm) Key	EACH	£2.20
K22119	No.7 (4.00mm) Key	EACH	£2.20
K22120	No.8 (4.25mm) Key	EACH	£2.20
K22121	No.9 (4.50mm) Key	EACH	£2.20
K22122	No.10 (4.75mm) Key	EACH	£2.20
K22123	No.11 (5.00mm) Key	EACH	£2.20
K22124	No.12 (5.25mm) Key	EACH	£2.20
K22125	No.13 (5.50mm) Key	EACH	£2.20

Price breaks available, see website

### Crank Keys, Vienna Regulator

Indian Sizes (not imperial) - Made in India

- Vienna Regulator
- Brass / Steel
- Indian Made
- Indian (not UK) Sizing (0 to 13)



(Numbering system for Indian made keys does not equal UK imperial number system)

Code	Description	UOM	Price
K22033	No.0 (1/0) (2.25mm) Key	EACH	£1.35
K22034	No.1 (2.50mm) Key	EACH	£1.35
K22035	No.2 (2.75mm) Key	EACH	£1.35
K22036	No.3 (3.00mm) Key	EACH	£1.35
K22037	No.4 (3.25mm) Key	EACH	£1.45
K22038	No.5 (3.50mm) Key	EACH	£1.45
K22039	No.6 (3.75mm) Key	EACH	£1.45

K22040	No.7 (4.00mm) Key	EACH	£1.75
K22041	No.8 (4.25mm) Key	EACH	£1.75
K22042	No.9 (4.50mm) Key	EACH	£1.75
K22043	No.10 (4.75mm) Key	EACH	£1.95
K22044	No.11 (5.00mm) Key	EACH	£1.95
K22045	No.12 (5.25mm) Key	EACH	£1.95
K22046	No.13 (5.50mm) Key	EACH	£1.95

Price breaks available, see website

### Crank Keys, Vienna Regulator, Brass Handle

Indian Sizes (not imperial) - Made in India

- Vienna Regulator
- Brass / Steel
- Brass handle
- Indian Made
- Indian (not UK) Sizing (0 to 13)



(Numbering system for Indian made keys does not equal UK imperial number system)

Code	Description	UOM	Price
K39672	No.0 (1/0) (2.25mm) Key	EACH	£2.75
K39673	No.1 (2.50mm) Key	EACH	£2.75
K39674	No.2 (2.75mm) Key	EACH	£2.75
K39675	No.3 (3.00mm) Key	EACH	£2.75
K39676	No.4 (3.25mm) Key	EACH	£2.75
K39677	No.5 (3.50mm) Key	EACH	£2.75
K39678	No.6 (3.75mm) Key	EACH	£2.75
K39679	No.7 (4.00mm) Key	EACH	£2.75
K39680	No.8 (4.25mm) Key	EACH	£2.75
K39681	No.9 (4.50mm) Key	EACH	£2.75
K39682	No.10 (4.75mm) Key	EACH	£2.75

### Double Ended, Ansonia

Indian Sizes (not imperial) - Made in India

Doubled ended with a second (1.75mm or 1.95mm) pipe fitted for the time adjustment on carriage, travel & ansonia clocks.



- Carriage Clock, Double Ended
- Brass
- Indian Made
- Second Pipe 1.75mm or 1.95mm
- Indian (not UK) Sizing (4 to 8)

Dimensions: Size x Second Pipe Size

(Numbering system for Indian made keys does not equal UK imperial number system)

Code	Description	UOM	Price
K22102	No.4 (3.25mm) x 1.75mm Key	EACH	£2.00
K22106	No.4 (3.25mm) x 1.95mm Key	EACH	£2.00
K22103	No.5 (3.50mm) x 1.75mm Key	EACH	£2.00
K22107	No.5 (3.50mm) x 1.95mm Key	EACH	£2.00
K22104	No.6 (3.75mm) x 1.75mm Key	EACH	£2.00
K22108	No.6 (3.75mm) x 1.95mm Key	EACH	£2.00
K22105	No.7 (4.00mm) x 1.75mm Key	EACH	£2.00
K22109	No.7 (4.00mm) x 1.95mm Key	EACH	£2.00
K22111	No.8 (4.25mm) x 1.75mm Key	EACH	£2.00
K22110	No.8 (4.25mm) x 1.95mm Key	EACH	£2.00

Price breaks available, see website



**ORDER tracking**

**Double Ended, Ansonia, Steel**

Indian Sizes (not imperial) -  
Made in India

Doubled ended with a second (1.75mm or 1.95mm) pipe fitted for the time adjustment on carriage or travel clocks.

- Carriage Clock, Double Ended
- Steel (Nickelled)
- Indian Made
- Second Pipe 1.75mm or 1.95mm
- Indian (not UK) Sizing (4 to 8)



(Numbering system for Indian made keys does not equal UK imperial number system)

Code	Description	UOM	Price
K22055	No.4 (3.25mm) x 1.75mm Key	EACH	£1.45
K22060	No.4 (3.25mm) x 1.95mm Key	EACH	£1.45
K22056	No.5 (3.50mm) x 1.75mm Key	EACH	£1.45
K22061	No.5 (3.50mm) x 1.95mm Key	EACH	£1.45
K22057	No.6 (3.75mm) x 1.75mm Key	EACH	£1.45
K22062	No.6 (3.75mm) x 1.95mm Key	EACH	£1.45
K22058	No.7 (4.00mm) x 1.75mm Key	EACH	£1.45
K22063	No.7 (4.00mm) x 1.95mm Key	EACH	£1.45
K22059	No.8 (4.25mm) x 1.75mm Key	EACH	£1.45
K22064	No.8 (4.25mm) x 1.95mm Key	EACH	£1.45
Price breaks available, see website			

**Double Ended, Carriage**

Indian Sizes (not imperial) -  
Made in India

Doubled ended with a second (1.75mm or 1.95mm) pipe fitted for the time adjustment on carriage or travel clocks.

- Carriage Clock, Double Ended
- Brass
- Indian Made
- Second Pipe 1.75mm or 1.95mm
- Indian (not UK) Sizing (0 to 10)



Dimensions: Size x Second Pipe Size

(Numbering system for Indian made keys does not equal UK imperial number system)

Code	Description	UOM	Price
K22080	No.0 (1/0 - 2.25) x 1.75mm Key	EACH	£1.60
K22091	No.0 (1/0 - 2.25) x 1.95mm Key	EACH	£1.60
K22081	No.1 (2.50mm) x 1.75mm Key	EACH	£1.60
K22092	No.1 (2.50mm) x 1.95mm Key	EACH	£1.60
K22082	No.2 (2.75mm) x 1.75mm Key	EACH	£1.60
K22093	No.2 (2.75mm) x 1.95mm Key	EACH	£1.60
K22083	No.3 (3.00mm) x 1.75mm Key	EACH	£1.60
K22094	No.3 (3.00mm) x 1.95mm Key	EACH	£1.60
K22084	No.4 (3.25mm) x 1.75mm Key	EACH	£1.60
K22095	No.4 (3.25mm) x 1.95mm Key	EACH	£1.60
K22085	No.5 (3.50mm) x 1.75mm Key	EACH	£1.60
K22096	No.5 (3.50mm) x 1.95mm Key	EACH	£1.60
K22086	No.6 (3.75mm) x 1.75mm Key	EACH	£1.60
K22097	No.6 (3.75mm) x 1.95mm Key	EACH	£1.60
K22087	No.7 (4.00mm) x 1.75mm Key	EACH	£1.60
K22098	No.7 (4.00mm) x 1.95mm Key	EACH	£1.60
K22088	No.8 (4.25mm) x 1.75mm Key	EACH	£1.60
K22099	No.8 (4.25mm) x 1.95mm Key	EACH	£1.60
K22089	No.9 (4.50mm) x 1.75mm Key	EACH	£1.60
K22100	No.9 (4.50mm) x 1.95mm Key	EACH	£1.60
K22090	No.10 (4.75mm) x 1.75mm Key	EACH	£1.60
K22101	No.10 (4.75mm) x 1.95mm Key	EACH	£1.60
Price breaks available, see website			

**Regular, Steel**

Indian Sizes (not imperial) -  
Made in India

- Standard
- Steel
- Indian Made
- Indian (not UK) Sizing (4 to 8)



(Numbering system for Indian made keys does not equal UK imperial number system)

Code	Description	UOM	Price
K22050	No.4 (3.25mm) Key	EACH	£1.20
K22051	No.5 (3.50mm) Key	EACH	£1.20
K22052	No.6 (3.75mm) Key	EACH	£1.20
K22053	No.7 (4.00mm) Key	EACH	£1.20
K22054	No.8 (4.25mm) Key	EACH	£1.50
Price breaks available, see website			

**Regular, Steel, Wing Tips**

Indian Sizes (not imperial) -  
Made in India

- Standard
- Steel colour
- Brass (Nickelled)
- Indian Made
- Indian (not UK) Sizing (00 to 14)



(Numbering system for Indian made keys does not equal UK imperial number system)

Code	Description	UOM	Price
K22142	No.00 (2/0) (2.00mm) Key	EACH	£0.95
K22143	No.0 (1/0) (2.25mm) Key	EACH	£0.95
K22144	No.1 (2.50mm) Key	EACH	£0.95
K22145	No.2 (2.75mm) Key	EACH	£0.95
K22146	No.3 (3.00mm) Key	EACH	£0.95
K22147	No.4 (3.25mm) Key	EACH	£1.05
K22148	No.5 (3.50mm) Key	EACH	£1.05
K22149	No.6 (3.75mm) Key	EACH	£1.05
K22150	No.7 (4.00mm) Key	EACH	£1.60
K22151	No.8 (4.25mm) Key	EACH	£1.60
K22152	No.9 (4.50mm) Key	EACH	£1.60
K22153	Nickel Key Size 10 (4.75mm)	EACH	£1.85
K22154	No.11 (5.00mm) Key	EACH	£1.85
K22155	No.12 (5.25mm) Key	EACH	£1.85
K22156	No.13 (5.50mm) Key	EACH	£2.15
K22157	No.14 (5.75mm) Key	EACH	£2.15
Price breaks available, see website			

**Seikosha, Steel**

Indian Sizes (not imperial) -  
Made in India

- Seikosha Pattern
- Steel colour
- Brass (Nickelled)
- Indian Made
- Indian (not UK) Sizing (8 only)



(Numbering system for Indian made keys does not equal UK imperial number system)

Code	Description	UOM	Price
K30557	No.8 (4.25mm) Key	EACH	£0.80
Price breaks available, see website			

**Star Keys**

Indian Sizes (not imperial) -  
Made in India

Good economical bench keys with pinned shanks on a disk hub.



- Standard
- Brass
- Indian Made
- Indian (not UK) Sizing (3 ranges)

(Numbering system for Indian made keys does not equal UK imperial number system)

Code	Description	UOM	Price
K22047	2, 4, 6, 8 & 10 Key	EACH	£2.95
K22048	3, 5, 7, 9 & 11 Key	EACH	£2.95
K22049	4, 6, 8, 10 & 12 Key	EACH	£2.95
Price breaks available, see website			

**Traditional, Brass**

Indian Sizes (not imperial) -  
Made in India

- Traditional Style
- Brass
- Indian Made
- Indian (not UK) Sizing (00 to 14)



(Numbering system for Indian made keys does not equal UK imperial number system)

Code	Description	UOM	Price
K22126	No.00 (2/0) (2.00mm) Key	EACH	£0.95
K22127	No.0 (1/0) (2.25mm) Key	EACH	£0.95
K22128	No.1 (2.50mm) Key	EACH	£0.95
K22129	No.2 (2.75mm) Key	EACH	£0.95
K22130	No.3 (3.00mm) Key	EACH	£0.95
K22131	No.4 (3.25mm) Key	EACH	£1.05
K22132	No.5 (3.50mm) Key	EACH	£1.05
K22133	No.6 (3.75mm) Key	EACH	£1.05
K22134	No.7 (4.00mm) Key	EACH	£1.60
K22135	No.8 (4.25mm) Key	EACH	£1.60
K22136	No.9 (4.50mm) Key	EACH	£1.60
K22137	No.10 (4.75mm) Key	EACH	£1.85
K22138	No.11 (5.00mm) Key	EACH	£1.85
K22139	No.12 (5.25mm) Key	EACH	£1.85
K22140	No.13 (5.50mm) Key	EACH	£2.00
K22141	No.14 (5.75mm) Key	EACH	£2.00
Price breaks available, see website			

**Traditional, Steel**

Indian Sizes (not imperial) -  
Made in India

- Traditional (Long, French Pattern)
- Steel colour
- Brass (Nickelled)
- Indian Made
- Indian (not UK) Sizing (1 to 15)



(Numbering system for Indian made keys does not equal UK imperial number system)

Code	Description	UOM	Price
K22065	No.1 (2.50mm) Key	EACH	£1.75
K22066	No.2 (2.75mm) Key	EACH	£1.75
K22067	No.3 (3.00mm) Key	EACH	£1.75
K22068	No.4 (3.25mm) Key	EACH	£1.95
K22069	No.5 (3.50mm) Key	EACH	£1.95

**PRICE PROMISE GUARANTEE**

K22070	No.6 (3.75mm) Key	EACH	£1.95
K22071	No.7 (4.00mm) Key	EACH	£1.95
K22072	No.8 (4.25mm) Key	EACH	£1.95
K22073	No.9 (4.50mm) Key	EACH	£1.95
K22074	No.10 (4.75mm) Key	EACH	£1.95
K22075	No.11 (5.00mm) Key	EACH	£1.95
K22076	No.12 (5.25mm) Key	EACH	£1.95
K22077	No.13 (5.50mm) Key	EACH	£1.95
K22078	No.14 (5.75mm) Key	EACH	£1.95
K22079	No.15 (6.00mm) Key	EACH	£1.95
Price breaks available, see website			

Pocket Watch Keys, Indian



Made in India

- Traditional Style
- Improved Quality
- Steel / Brass
- Made in India
- Indian (not UK) Sizing (00 to 12)

(Numbering system for Indian made keys does not equal UK imperial number system)

Set K22016 contains:

- 14 keys (one of each size)

Code	Description	UOM	Price
K22016	Set of 14 Keys	PACK*14	£3.95
K22000	No.00 (2.00mm) Key	EACH	£1.65
K22001	No.0 (1.90mm) Key	EACH	£1.65
K22002	No.1 (1.80mm) Key	EACH	£1.65
K22003	No.2 (1.75mm) Key	EACH	£1.65
K22004	No.3 (1.65mm) Key	EACH	£1.65
K22005	No.4 (1.60mm) Key	EACH	£1.65
K22006	No.5 (1.50mm) Key	EACH	£1.65
K22007	No.6 (1.40mm) Key	EACH	£1.65
K22008	No.7 (1.30mm) Key	EACH	£1.65
K22009	No.8 (1.20mm) Key	EACH	£1.65
K22010	No.9 (1.15mm) Key	EACH	£1.65
K22011	No.10 (1.05mm) Key	EACH	£1.65
K22012	No.11 (1.00mm) Key	EACH	£1.65
K22013	No.12 (0.95mm) Key	EACH	£1.65
Price breaks available, see website			

POCKET WATCH KEYS

Pocket Watch Keys

- Swiss Made (UK Sizes)
- Indian Made (Indian number system does not equal UK imperial number system)

UK Sizes:

- UK: 00 = 0.95mm.....Indian: 00 = 2.00mm
- UK: 0 = 1.00mm.....Indian: 0 = 1.90mm
- UK: 1 = 1.05mm.....Indian: 1 = 1.80mm
- UK: 2 = 1.15mm.....Indian: 2 = 1.75mm
- UK: 3 = 1.20mm.....Indian: 3 = 1.65mm
- UK: 4 = 1.30mm.....Indian: 4 = 1.60mm
- UK: 5 = 1.40mm.....Indian: 5 = 1.50mm
- UK: 6 = 1.50mm.....Indian: 6 = 1.40mm
- UK: 7 = 1.60mm.....Indian: 7 = 1.30mm
- UK: 8 = 1.65mm.....Indian: 8 = 1.20mm
- UK: 9 = 1.75mm.....Indian: 9 = 1.15mm
- UK: 10 = 1.80mm.....Indian: 10 = 1.05mm
- UK: 11 = 1.90mm.....Indian: 11 = 1.00mm
- UK: 12 = 2.00mm.....Indian: 12 = 0.95mm

Pocket Watch Keys, Swiss

Made in Switzerland

- Traditional Style
- High Quality - Universo
- Steel / Brass
- Swiss Made
- Imperial UK Sizing (00 to 12)



(Numbering system for Indian made keys does not equal UK imperial number system)

Code	Description	UOM	Price
K3093M	No.00 (0.95mm) Key	EACH	£9.50
K3094M	No.0 (1.00mm) Key	EACH	£9.50
K3095M	No.1 (1.05mm) Key	EACH	£9.50
K3096M	No.2 (1.15mm) Key	EACH	£9.50
K3097M	No.3 (1.20mm) Key	EACH	£9.50
K3098M	No.4 (1.30mm) Key	EACH	£9.50
K3099M	No.5 (1.40mm) Key	EACH	£9.50
K3100M	No.6 (1.50mm) Key	EACH	£9.50
K3101M	No.7 (1.60mm) Key	EACH	£9.50
K3102M	No.8 (1.65mm) Key	EACH	£9.50
K3103M	No.9 (1.75mm) Key	EACH	£9.50
K3104M	No.10 (1.80mm) Key	EACH	£9.50
K3105M	No.11 (1.90mm) Key	EACH	£9.50
K3106M	No.12 (2.00mm) Key	EACH	£9.50
Price breaks available, see website			

Pocket Watch Star Keys, Swiss

Made in Switzerland

Strong bench keys with pinned shanks on a solid hub.

- Traditional Style
- High Quality, Universo
- Steel
- Swiss Made
- Imperial UK Sizing (2 ranges)



Code	Description	UOM	Price
K3523	No.2, 4, 6, 8 & 10 Key	EACH	£46.95
K3524	No.3, 5, 7, 9 & 11 Key	EACH	£46.95

Pocket Watch Star Keys, Indian

Made in India

Economical bench keys with pinned shanks on a disk hub.

- Traditional Style
- Improved Quality
- Steel (nickelled)
- Made in India
- Imperial Indian (not UK) Sizing (2 ranges)



(Numbering system for Indian made keys does not equal UK imperial number system)

Code	Description	UOM	Price
K22014	No.2, 4, 6, 8 & 10 Keys	EACH	£1.95
K22015	No.3, 5, 7, 9 & 11 Keys	EACH	£1.95
Price breaks available, see website			

KEY HOLDERS, CLOCK

Clock Case Key Holders



Clock Case Key Holder

Convenient for storing a clock key in the back of a clock case, preventing loss or damage if the clock is moved with the key just laying in the bottom.

- Black plastic, resilient key holders
- Attach to case to hold key
- Pack\*12

Dimensions: 22 x 9mm

Code	Description	UOM	Price
C5340	Clock Key Holders	PACK*12	£1.75

LINES & ROPES



- American Clock Cord
- Bronze
- Galvanised Steel
- Natural Gut
- Rope
- Steel Lines
- Steel Vinyl Covered
- Synthetic (Gut) Perlon

Comtoise Clock Cord



Comtoise Clock Cord

- Ø2mm cord
- 21 feet spool (6.4 metres)
- Designed for Comtoise clocks
- Natural colour

Code	Description	UOM	Price
S48961	Ø2mm Clock Cord	21FT	£4.95
Price breaks available, see website			

Pocket Size Multi Purpose Oiler

See Page 1182



### English Dial Fusee Clock Lines

English Dial Fusee Clock Lines

- Bronze
- Galvanised Steel
- Natural Gut\*
- Steel Vinyl Covered

\*As gut line is a natural product and may vary, it does not have a recommended weight tolerance or a safe working load weight.

Length:

- 5 feet (1.52 metres)

Diameters:

- Ø1.40mm
- Ø1.45mm
- Ø1.50mm

#### Bronze (Ø1.40mm) Line

English Dial Fusee Clock Line

- Diameter Ø1.40mm
- Length 5 feet (1.52 metres)



Code	Description	UOM	Price
G5032	Bronze (Ø1.40mm) Line	5FT	£3.60

#### Galvanised Steel (Ø1.50mm) Line

English Dial Fusee Clock Line

- Galvanised Steel
- Diameter Ø1.50mm
- Length 5 feet (1.52 Metres)



Code	Description	UOM	Price
G5031	Galvanised Steel (Ø1.50mm) Line	5FT	£2.50

#### Natural Gut (Ø1.40mm) Line

English Dial Fusee Clock Line

- Diameter Ø1.40mm
- Length 5 feet (1.52 Metres)

As gut line is a natural product and may vary, it does not have a recommended weight tolerance or a safe working load weight.



Code	Description	UOM	Price
G0760	Natural Gut (Ø1.40mm) Line	5FT	£1.65

#### Vinyl Covered Steel (Ø1.45mm) Line

English Dial Fusee Clock Line

- Galvanised Steel Vinyl Covered
- Diameter Ø1.45mm
- Length 5 feet (1.52 Metres)



Code	Description	UOM	Price
G5145	Vinyl Covered Steel (Ø1.45mm) Line	5FT	£2.37
Price breaks available, see website			

### Longcase Clock Lines

Longcase Clock Lines

- Bronze
- Galvanised Steel
- Natural Gut\*
- Steel Vinyl Covered
- Synthetic (Gut) Perlon

\*As gut line is a natural product and may vary, it does not have a recommended weight tolerance or a safe working load weight.

Length:

- 21 feet (6.4 metres)

Diameters:

- Ø1.40mm
- Ø1.50mm

#### Bronze (Ø1.40mm) Line

Longcase Clock Line

- Bronze
- Diameter Ø1.40mm
- Length 21 feet (6.4 Metres)



Code	Description	UOM	Price
G0761	Bronze (Ø1.40mm) Line	21FT	£15.25

#### Galvanised Steel (Ø1.50mm) Line

Longcase Clock Line

- Galvanised Steel
- Diameter Ø1.50mm
- Length 21 feet (6.4 Metres)



Code	Description	UOM	Price
G0763	Galvanised Steel (Ø1.50mm) Line	21FT	£3.65

#### Natural Gut (Ø1.40mm) Line

Longcase Clock Line

- Natural Gut
- Diameter Ø1.40mm
- Length 21 feet (6.4 Metres)



As gut line is a natural product and may vary, it does not have a recommended weight tolerance or a safe working load weight.

Code	Description	UOM	Price
G0762	Natural Gut (Ø1.40mm) Line	21FT	£4.55

#### Vinyl Covered Steel (Ø1.50mm) Line

Longcase Clock Line

- Galvanised Steel
- Diameter Ø1.50mm
- Length 21 feet (6.4 Metres)



Code	Description	UOM	Price
G5146	Vinyl Covered Steel (Ø1.50mm) Line	21FT	£8.65

### Synthetic Perlon (Ø1.40mm) Line

Longcase Clock Line

- Diameter Ø1.40mm
- Gut Coloured Perlon Monofilament
- 21 feet



Code	Description	UOM	Price
G4931	Synthetic Perlon (Ø1.40mm) Line	21FT	£2.85

### Synthetic Perlon (Ø1.40mm) Line

Longcase Clock Line

- Diameter Ø1.40mm
- Gut Coloured Perlon Monofilament
- 1000 Metres / 3,333 FT



Code	Description	UOM	Price
G19512	Synthetic Perlon (Ø1.40mm) Line	1000M	£75.00
Price breaks available, see website			

### Longcase Clock Ropes



Longcase (Grandfather) Clock Ropes - 30 Hour Clocks

- High Quality British Manufacture
- Wooven Linen
- Central Core

Length:

- 12 feet

Diameters:

- Ø5.0mm
- Ø5.5mm
- Ø6.0mm
- Ø7.0mm
- Ø8.0mm

Code	Description	UOM	Price
R1464	Ø5.0mm Rope	12FT	£4.50
R4962	Ø5.5mm Rope	12FT	£5.25
R1465	Ø6.0mm Rope	12FT	£5.95
R1466	Ø7.0mm Rope	12FT	£6.95
R4961	Ø8.0mm Rope	12FT	£8.45
Price breaks available, see website			

www. Online Discounts

SAME DAY DISPATCH

PRICE PROMISE GUARANTEE

TRADE SUPPLIER

**Modern Mechanical Clock Lines**



Modern Mechanical Clock Lines - Specially Thin

- Special thin metal clock lines
- For modern weight driven mechanical clocks
- All our metal clock lines are top quality stranded and flexible products
- Galvanised Steel

Length:  
• 7 metres

Diameters:  
• Ø0.90mm

Code	Description	UOM	Price
<b>G7886</b>	Galvanised Steel Ø0.90mm line	7M	<b>£19.95</b>
Price breaks available, see website			

**Vienna Regulator Gut Lines**



Vienna Regulator Clock Lines

- Natural Gut\*

\*As gut line is a natural product and may vary, it does not have a recommended weight tolerance or a safe working load weight.

Length:  
• 21 feet (6.4 metres)

Diameters:  
• Ø0.65mm  
• Ø0.80mm

Code	Description	UOM	Price
<b>G0765</b>	Ø0.65mm Natural Gut Line	21FT	<b>£5.95</b>
<b>G6476</b>	Ø0.80mm Natural Gut Line	21FT	<b>£5.95</b>
Price breaks available, see website			

**Online Discounts**

**Flush Cutting Cutters**

See Page 829

**Clock Pulleys**

See Page 1351

**MAINSPRINGS (CLOCK)**

**400 DAY CLOCK MAINSPRINGS**

**Horolovar 400 Day (Anniversary)**



Horolovar - 400 Day (Anniversary) Clock Mainsprings

- Strong springs specifically for 400 Day clocks
- Horolovar brand are coiled undersized to slide easily into barrel drum
- Made in U.S.A.

Dimensions: Height x Thickness (Strength) x Diameter.

Code	Description	UOM	Price
<b>123032</b>	12 x 0.30 x 1232 x Ø32mm 400 Day, Horolovar	EACH	<b>£13.95</b>
<b>123325</b>	12 x 0.33 x 637 x Ø25mm 400 Day, Horolovar	EACH	<b>£13.95</b>
<b>123824</b>	12 x 0.38 x 584 x Ø24mm 400 Day, Horolovar	EACH	<b>£13.95</b>
<b>133630</b>	13 x 0.36 x 972 x Ø30mm 400 Day, Horolovar	EACH	<b>£13.95</b>
<b>135532</b>	13 x 0.55 x 714 x Ø32mm 400 Day, Horolovar	EACH	<b>£13.95</b>
<b>143325</b>	14 x 0.33 x 697 x Ø25mm 400 Day, Horolovar	EACH	<b>£13.95</b>
<b>143630</b>	14 x 0.36 x 815 x Ø30mm 400 Day, Horolovar	EACH	<b>£13.95</b>
<b>155032A</b>	15 x 0.50 x 760 x Ø32mm 400 Day, Horolovar	EACH	<b>£13.95</b>
<b>144128</b>	14 x 0.41 x 720 x Ø28mm 400 Day, Horolovar	EACH	<b>£13.95</b>
<b>144632</b>	14 x 0.46 x 1041 x Ø32mm 400 Day, Horolovar	EACH	<b>£13.95</b>
<b>164636</b>	16 x 0.46 x 1039 x Ø36mm 400 Day, Horolovar	EACH	<b>£17.95</b>
<b>184638</b>	18 x 0.46 x 1118 x Ø38mm 400 Day, Horolovar	EACH	<b>£17.95</b>
<b>194132</b>	19 x 0.41 x 951 x Ø32mm 400 Day, Horolovar	EACH	<b>£17.95</b>
<b>194138</b>	19 x 0.41 x 1346 x Ø38mm 400 Day, Horolovar	EACH	<b>£17.95</b>
<b>194336</b>	19 x 0.43 x 1143 x Ø36mm 400 Day, Horolovar	EACH	<b>£17.95</b>
<b>204138</b>	20 x 0.41 x 1346 x Ø38mm 400 Day, Horolovar	EACH	<b>£17.95</b>
<b>213850</b>	21 x 0.38 x 1780 x Ø50mm 400 Day, Horolovar	EACH	<b>£25.25</b>
Price breaks available, see website			

**TRADE SUPPLIER**

**400 Day Clock Beat Setting Tool**

See Page 776

**Trifix 400 Day (Anniversary)**



Trifix - 400 Day (Anniversary) Clock Mainsprings

- Strong springs specifically for 400 Day clocks
- Made in Germany

Dimensions: Height x Thickness (Strength) x Diameter.

Code	Description	UOM	Price
<b>123032A</b>	12 x 0.30 x 1232 x 32mm 400 Day, Trifix	EACH	<b>£4.95</b>
<b>M42407</b>	12 x 0.33 x 637 x Ø25mm 400 Day, Trifix	EACH	<b>£3.95</b>
<b>123824A</b>	12 x 0.38 x 584 x 24mm 400 Day, Trifix	EACH	<b>£3.95</b>
<b>M42408</b>	13 x 0.36 x 972 x Ø30mm 400 Day, Trifix	EACH	<b>£4.95</b>
<b>M42409</b>	13 x 0.55 x 714 x Ø32mm 400 Day, Trifix	EACH	<b>£4.95</b>
<b>M42410</b>	14 x 0.33 x 697 x Ø25mm 400 Day, Trifix	EACH	<b>£4.95</b>
<b>M42411</b>	14 x 0.36 x 815 x Ø30mm 400 Day, Trifix	EACH	<b>£4.95</b>
<b>M42412</b>	14 x 0.41 x 720 x Ø28mm 400 Day, Trifix	EACH	<b>£4.95</b>
<b>144632A</b>	14 x 0.46 x 1041 x 32mm 400 Day, Trifix	EACH	<b>£4.95</b>
<b>155032AA</b>	15 x 0.50 x 760 x 32mm 400 Day, Trifix	EACH	<b>£5.95</b>
<b>M42413</b>	16 x 0.46 x 1039 x Ø36mm 400 Day, Trifix	EACH	<b>£6.95</b>
<b>M42414</b>	18 x 0.46 x 1118 x Ø38mm 400 Day, Trifix	EACH	<b>£6.95</b>
<b>194132AA</b>	19 x 0.41 x 951 x 32mm 400 Day, Trifix	EACH	<b>£6.95</b>
<b>M42415</b>	19 x 0.41 x 1346 x Ø38mm 400 Day, Trifix	EACH	<b>£6.95</b>
<b>194336A</b>	19 x 0.43 x 1143 x 36mm 400 Day, Trifix	EACH	<b>£7.50</b>
<b>204138A</b>	20 x 0.41 x 1346 x 38mm 400 Day, Trifix	EACH	<b>£9.95</b>
<b>213850A</b>	21 x 0.38 x 1780 x 50mm 400 Day, Trifix	EACH	<b>£12.75</b>
Price breaks available, see website			

**AMERICAN ANSONIA (TRIFIX) CLOCK MAINSPRINGS**

**American Ansonia**



Ansonia (American) Clock Mainsprings - Trifix

- High Quality
- Made in Germany
- Rivetted loop end
- Suitable for both going and strike sides
- Sizes in millimetres

Dimensions: Height x Thickness (Strength) x Length x Diameter

Code	Description	UOM	Price
<b>ANS10</b>	10 x 0.45 x 2500 x Ø47mm	EACH	<b>£6.95</b>

<b>ANS1242</b>	12 x 0.42 x 2500 x Ø50mm	EACH	<b>£6.95</b>
<b>ANS12</b>	12 x 0.45 x 2500 x Ø47mm	EACH	<b>£6.95</b>
<b>ANS14</b>	14 x 0.45 x 2500 x Ø47mm	EACH	<b>£7.95</b>
<b>ANS1540</b>	15 x 0.40 x 2500 x Ø47mm	EACH	<b>£7.95</b>
<b>ANS15</b>	15 x 0.45 x 2500 x Ø47mm	EACH	<b>£7.95</b>
<b>ANS1635</b>	16 x 0.35 x 2500 x Ø47mm	EACH	<b>£8.95</b>
<b>ANS16</b>	16 x 0.45 x 2500 x Ø47mm	EACH	<b>£8.95</b>
<b>ANS1650</b>	16 x 0.45 x 2500 x Ø50mm	EACH	<b>£8.95</b>
<b>ANS1835</b>	18 x 0.35 x 2600 x Ø47mm	EACH	<b>£8.95</b>
<b>ANS18</b>	18 x 0.45 x 2500 x Ø47mm	EACH	<b>£8.95</b>
<b>ANS1936</b>	19 x 0.36 x 2600 x Ø47mm	EACH	<b>£8.95</b>
<b>ANS1940</b>	19 x 0.40 x 2500 x Ø47mm	EACH	<b>£8.95</b>
<b>ANS19</b>	19 x 0.45 x 2500 x Ø47mm	EACH	<b>£8.95</b>
<b>ANS1955</b>	19 x 0.55 x 2450 x Ø47mm	EACH	<b>£8.95</b>
<b>ANS2040</b>	20 x 0.40 x 2500 x Ø47mm	EACH	<b>£13.15</b>
<b>ANS2045</b>	20 x 0.45 x 2500 x Ø47mm	EACH	<b>£13.15</b>
<b>ANS2140</b>	21 x 0.40 x 2500 x Ø47mm	EACH	<b>£13.15</b>
<b>ANS2145</b>	21 x 0.45 x 2500 x Ø47mm	EACH	<b>£13.15</b>
Price breaks available, see website			

**ENGLISH DIAL, FRENCH & GERMAN (TRIFIX) CLOCK MAINSPRING**

**English Dial (Fusee), French & German**



**Trifix Range of Clock Mainsprings**

Trifix have a very large stock of carbon steel and can provide many spring sizes which can be rarely needed. If you have such a special request, please let us know via the website online support facility and if it is available, we shall include it in the list below.

- The famous Trifix "Fix" brand mainsprings
- Sizes in millimetres
- Patented Sorbitech 90/Texturbrand carbon steel
- Trifix mainsprings are supplied lubricated, no additional cleaning is required prior to use
- Hardened using nitrogen (not oxygen) to ensure the material lasts longer and is more resilient
- List includes special Swiss made mainsprings, manufactured by Generale Ressorts, that are specific to make and calibre (in brackets)

Dimensions: Height x Thickness (Strength) x Length x Diameter

Code	Description	UOM	Price
<b>101A770</b>	1.80 x 0.18 x 550 x 16mm (to fit Europa 101 (Alarm))	EACH	<b>£7.30</b>
<b>SWI48770A</b>	2.30 x 0.18 x 540 x 16mm (Swiza 48 (Alarm))	EACH	<b>£7.30</b>
<b>26770</b>	2.40 x 0.19 x 840 x 20mm (to fit Swiza 26)	EACH	<b>£13.15</b>
<b>JLC2117771</b>	2.50 x 0.15 x 720 x 17mm (to fit JLC 211 (Alarm))	EACH	<b>£9.95</b>
<b>101770</b>	2.80 x 0.25 x 560 x 18mm (to fit Europa 101 (Time))	EACH	<b>£11.95</b>
<b>SWI48770T</b>	3.30 x 0.20 x 670 x 18mm (to fit Swiza 48 (Time))	EACH	<b>£7.30</b>
<b>944770</b>	3.60 x 0.24 x 550 x 18mm (to fit Imhof 944)	EACH	<b>£7.30</b>
<b>00770</b>	3.60 x 0.27 x 650 x 21mm (to fit Europa 00)	EACH	<b>£7.30</b>
<b>211770</b>	4.00 x 0.20 x 1150 x 25mm (to fit Swiza 21 (1 day))	EACH	<b>£14.85</b>
<b>R10770</b>	4 x 0.23 x 680 x 20mm (to fit Cyma R10)	EACH	<b>£11.95</b>
<b>42521</b>	4 x 0.25 x 680 x 21mm	EACH	<b>£3.00</b>

<b>43026</b>	4 x 0.30 x 950 x 26mm	EACH	<b>£3.00</b>
<b>50770A</b>	4.10 x 0.14 x 380 x 12mm (to fit Looping 50/51 (8 day) - Alarm side)	EACH	<b>£12.45</b>
<b>44770</b>	4.30 x 0.25 x 750 x 22mm (to fit Looping 44)	EACH	<b>£7.30</b>
<b>244770</b>	4.60 x 0.26 x 720 x 21mm (to fit Imhof 244B)	EACH	<b>£5.95</b>
<b>50770</b>	4.75 x 0.20 x 550 x 17mm (to fit Looping 50/51 (8 day) - Time side)	EACH	<b>£12.45</b>
<b>R815770</b>	5 x 0.24 x 720 x 21mm (to fit Cyma R815)	EACH	<b>£7.30</b>
<b>53539</b>	5 x 0.35 x 2000 x 39mm	EACH	<b>£3.70</b>
<b>544770</b>	5.50 x 0.26 x 720 x 21mm (to fit Imhof 544)	EACH	<b>£12.50</b>
<b>948770</b>	5.60 x 0.26 x 1600 x 34mm (to fit Imhof 948)	EACH	<b>£7.30</b>
<b>81770</b>	5.75 x 0.23 x 840 x 23mm (Looping 81)	EACH	<b>£7.30</b>
<b>8770</b>	5.90 x 0.24 x 650 x 21mm (to fit Swiza 8/25)	EACH	<b>£12.45</b>
<b>218770</b>	6.50 x 0.29 x 930 x 25mm (Swiza 21 (8 day))	EACH	<b>£14.85</b>
<b>82528</b>	8 x 0.25 x 700 x 28mm	EACH	<b>£3.00</b>
<b>83230</b>	8 x 0.32 x 950 x 30mm	EACH	<b>£3.80</b>
<b>92022</b>	9 x 0.20 x 350 x 22mm	EACH	<b>£3.00</b>
<b>102525</b>	10 x 0.25 x 950 x 25mm	EACH	<b>£3.00</b>
<b>102530</b>	10 x 0.25 x 1350 x 30mm	EACH	<b>£3.80</b>
<b>103026</b>	10 x 0.30 x 950 x 26mm	EACH	<b>£3.00</b>
<b>103030</b>	10 x 0.30 x 1250 x 30mm	EACH	<b>£3.80</b>
<b>112525</b>	11 x 0.25 x 1000 x 25mm	EACH	<b>£3.00</b>
<b>112732</b>	11 x 0.27 x 1370 x 32mm	EACH	<b>£3.90</b>
<b>113030</b>	11 x 0.30 x 1250 x 30mm	EACH	<b>£3.80</b>
<b>122525</b>	12 x 0.25 x 1000 x 25mm	EACH	<b>£3.00</b>
<b>122530</b>	12 x 0.25 x 1350 x 30mm	EACH	<b>£3.80</b>
<b>122830</b>	12 x 0.28 x 1250 x 30mm	EACH	<b>£3.80</b>
<b>123030</b>	12 x 0.30 x 1250 x 30mm	EACH	<b>£3.80</b>
<b>123032</b>	12 x 0.30 x 1232 x 32mm 400 Day, Horolovar	EACH	<b>£13.95</b>
<b>123032A</b>	12 x 0.30 x 1232 x 32mm 400 Day, Trifix	EACH	<b>£4.95</b>
<b>123234A</b>	12 x 0.32 x 1150 x 34mm (to fit Hermle barrel 33)	EACH	<b>£4.95</b>
<b>123234</b>	12 x 0.32 x 1350 x 34mm	EACH	<b>£4.15</b>
<b>123325</b>	12 x 0.33 x 637 x 25mm 400 Day, Horolovar	EACH	<b>£13.95</b>
<b>M42407</b>	12 x 0.33 x 637 x 25mm 400 Day, Trifix	EACH	<b>£3.95</b>
<b>123434</b>	12 x 0.34 x 1150 x 34mm (to fit Hermle barrel 31)	EACH	<b>£4.95</b>
<b>123526</b>	12 x 0.35 x 950 x 26mm	EACH	<b>£4.15</b>
<b>123535</b>	12 x 0.35 x 1400 x 35mm	EACH	<b>£4.15</b>
<b>123824</b>	12 x 0.38 x 584 x 24mm 400 Day, Horolovar	EACH	<b>£13.95</b>
<b>123824A</b>	12 x 0.38 x 584 x 24mm 400 Day, Trifix	EACH	<b>£3.95</b>
<b>123834</b>	12 x 0.38 x 1200 x 34mm	EACH	<b>£4.15</b>
<b>124035</b>	12 x 0.40 x 1150 x 35mm	EACH	<b>£4.95</b>
<b>124040</b>	12 x 0.40 x 1500 x 40mm	EACH	<b>£4.95</b>
<b>124333</b>	12 x 0.43 x 1100 x 33mm	EACH	<b>£4.15</b>
<b>124434</b>	12 x 0.44 x 1100 x 34mm (to fit Hermle barrels 30 & 32)	EACH	<b>£4.95</b>
<b>132020</b>	13 x 0.20 x 700 x 20mm	EACH	<b>£3.00</b>
<b>132525</b>	13 x 0.25 x 950 x 25mm	EACH	<b>£3.00</b>
<b>133030</b>	13 x 0.30 x 1250 x 30mm	EACH	<b>£3.80</b>
<b>133032</b>	13 x 0.30 x 1320 x 32mm	EACH	<b>£3.80</b>
<b>133535</b>	13 x 0.35 x 1400 x 35mm	EACH	<b>£3.80</b>
<b>133630</b>	13 x 0.36 x 972 x 30mm 400 Day, Horolovar	EACH	<b>£13.95</b>
<b>M42408</b>	13 x 0.36 x 972 x 30mm 400 Day, Trifix	EACH	<b>£4.95</b>
<b>133844</b>	13 x 0.38 x 1650 x 44mm	EACH	<b>£4.95</b>
<b>135032</b>	13 x 0.50 x 760 x 32mm	EACH	<b>£4.95</b>
<b>135532</b>	13 x 0.55 x 714 x 32mm 400 Day, Horolovar	EACH	<b>£13.95</b>
<b>M42409</b>	13 x 0.55 x 714 x 32mm 400 Day, Trifix	EACH	<b>£4.95</b>
<b>142525</b>	14 x 0.25 x 1000 x 25mm	EACH	<b>£3.00</b>
<b>142530</b>	14 x 0.25 x 1350 x 30mm	EACH	<b>£3.80</b>
<b>143030</b>	14 x 0.30 x 1250 x 30mm	EACH	<b>£3.80</b>
<b>143040</b>	14 x 0.30 x 1900 x 40mm	EACH	<b>£4.95</b>
<b>143325</b>	14 x 0.33 x 697 x 25mm 400 Day, Horolovar	EACH	<b>£13.95</b>
<b>M42410</b>	14 x 0.33 x 697 x 25mm 400 Day, Trifix	EACH	<b>£4.95</b>
<b>143530</b>	14 x 0.35 x 1000 x 30mm	EACH	<b>£3.80</b>

<b>143535</b>	14 x 0.35 x 1400 x 35mm	EACH	<b>£3.80</b>
<b>143540</b>	14 x 0.35 x 1650 x 40mm	EACH	<b>£4.95</b>
<b>143630</b>	14 x 0.36 x 815 x 30mm 400 Day, Horolovar	EACH	<b>£13.95</b>
<b>M42411</b>	14 x 0.36 x 815 x 30mm 400 Day, Trifix	EACH	<b>£4.95</b>
<b>143930</b>	14 x 0.39 x 900 x 30mm	EACH	<b>£3.80</b>
<b>144038</b>	14 x 0.40 x 1400 x 38mm	EACH	<b>£4.95</b>
<b>144040</b>	14 x 0.40 x 1500 x 40mm	EACH	<b>£4.95</b>
<b>144128</b>	14 x 0.41 x 720 x 28mm 400 Day, Horolovar	EACH	<b>£13.95</b>
<b>M42412</b>	14 x 0.41 x 720 x 28mm 400 Day, Trifix	EACH	<b>£4.95</b>
<b>144545</b>	14 x 0.45 x 1650 x 45mm	EACH	<b>£4.95</b>
<b>144632</b>	14 x 0.46 x 1041 x 32mm 400 Day, Horolovar	EACH	<b>£13.95</b>
<b>144632A</b>	14 x 0.46 x 1041 x 32mm 400 Day, Trifix	EACH	<b>£4.95</b>
<b>152525</b>	15 x 0.25 x 1100 x 25mm	EACH	<b>£3.80</b>
<b>152530</b>	15 x 0.25 x 1350 x 30mm	EACH	<b>£4.20</b>
<b>153025</b>	15 x 0.30 x 900 x 25mm	EACH	<b>£3.80</b>
<b>153030</b>	15 x 0.30 x 1250 x 30mm	EACH	<b>£4.20</b>
<b>153535</b>	15 x 0.35 x 1400 x 35mm	EACH	<b>£4.20</b>
<b>153638</b>	15 x 0.36 x 1600 x 38mm	EACH	<b>£6.50</b>
<b>154040</b>	15 x 0.40 x 1500 x 40mm	EACH	<b>£6.25</b>
<b>154545</b>	15 x 0.45 x 1650 x 45mm	EACH	<b>£6.25</b>
<b>154835</b>	15 x 0.48 x 1000 x 35mm	EACH	<b>£4.20</b>
<b>155032</b>	15 x 0.50 x 730 x 32mm	EACH	<b>£4.20</b>
<b>155032A</b>	15 x 0.50 x 760 x 32mm 400 Day, Horolovar	EACH	<b>£13.95</b>
<b>155032AA</b>	15 x 0.50 x 760 x 32mm 400 Day, Trifix	EACH	<b>£5.95</b>
<b>162525</b>	16 x 0.25 x 1000 x 25mm	EACH	<b>£3.80</b>
<b>162530</b>	16 x 0.25 x 1350 x 30mm	EACH	<b>£4.20</b>
<b>163030</b>	16 x 0.30 x 1250 x 30mm	EACH	<b>£4.20</b>
<b>163035</b>	16 x 0.30 x 1500 x 35mm	EACH	<b>£4.20</b>
<b>163530</b>	16 x 0.35 x 1000 x 30mm	EACH	<b>£4.20</b>
<b>163535</b>	16 x 0.35 x 1400 x 35mm	EACH	<b>£4.20</b>
<b>163833</b>	16 x 0.38 x 1050 x 33mm	EACH	<b>£4.95</b>
<b>163835</b>	16 x 0.38 x 1100 x 35mm	EACH	<b>£4.30</b>
<b>164040</b>	16 x 0.40 x 1500 x 40mm	EACH	<b>£6.25</b>
<b>164545</b>	16 x 0.45 x 1650 x 45mm	EACH	<b>£5.85</b>
<b>164636</b>	16 x 0.46 x 1039 x 36mm 400 Day, Horolovar	EACH	<b>£17.95</b>
<b>M42413</b>	16 x 0.46 x 1039 x 36mm 400 Day, Trifix	EACH	<b>£6.95</b>
<b>164848</b>	16 x 0.48 x 1700 x 48mm	EACH	<b>£9.20</b>
<b>172525</b>	17 x 0.25 x 1000 x 25mm	EACH	<b>£3.80</b>
<b>173030</b>	17 x 0.30 x 1250 x 30mm	EACH	<b>£4.20</b>
<b>173535</b>	17 x 0.35 x 1400 x 35mm	EACH	<b>£4.20</b>
<b>173835</b>	17 x 0.38 x 1100 x 35mm (to fit Hermle barrels 40 & 42)	EACH	<b>£4.95</b>
<b>173838</b>	17 x 0.38 x 1200 x 38mm (to fit Hermle barrel 56)	EACH	<b>£6.50</b>
<b>174038</b>	17 x 0.40 x 1200 x 38mm (to fit Hermle barrels 20, 21 & 50)	EACH	<b>£6.50</b>
<b>174040</b>	17 x 0.40 x 1500 x 40mm	EACH	<b>£5.85</b>
<b>174045</b>	17 x 0.40 x 1700 x 45mm	EACH	<b>£6.25</b>
<b>174238</b>	17 x 0.42 x 1200 x 38mm (to fit Hermle barrel 52)	EACH	<b>£6.50</b>
<b>174242</b>	17 x 0.42 x 1500 x 42mm (to fit Hermle barrel 11)	EACH	<b>£6.50</b>
<b>174540</b>	17 x 0.45 x 1400 x 40mm	EACH	<b>£6.25</b>
<b>174542</b>	17 x 0.45 x 1490 x 42mm (to fit Hermle barrel 10)	EACH	<b>£6.50</b>
<b>174545</b>	17 x 0.45 x 1650 x 45mm	EACH	<b>£5.85</b>
<b>174546</b>	17 x 0.45 x 1800 x 46mm (to fit Hermle barrel 55)	EACH	<b>£9.50</b>
<b>182525</b>	18 x 0.25 x 1000 x 25mm	EACH	<b>£3.80</b>
<b>182528</b>	18 x 0.25 x 1300 x 28mm	EACH	<b>£4.20</b>
<b>182530</b>	18 x 0.25 x 1350 x 30mm	EACH	<b>£4.20</b>
<b>183030</b>	18 x 0.30 x 1250 x 30mm	EACH	<b>£4.20</b>
<b>183535</b>	18 x 0.35 x 1400 x 35mm	EACH	<b>£4.50</b>
<b>184040</b>	18 x 0.40 x 1500 x 40mm	EACH	<b>£6.25</b>
<b>184045</b>	18 x 0.40 x 1700 x 45mm	EACH	<b>£6.25</b>
<b>184540</b>	18 x 0.45 x 1400 x 40mm	EACH	<b>£6.25</b>
<b>184545</b>	18 x 0.45 x 1650 x 45mm	EACH	<b>£5.85</b>
<b>184638</b>	18 x 0.46 x 1118 x 38mm 400 Day, Horolovar	EACH	<b>£17.95</b>
<b>M42414</b>	18 x 0.46 x 1118 x 38mm 400 Day, Trifix	EACH	<b>£6.95</b>
<b>184848</b>	18 x 0.48 x 1650 x 48mm	EACH	<b>£9.20</b>
<b>185045</b>	18 x 0.50 x 1600 x 45mm	EACH	<b>£6.25</b>

192525	19 x 0.25 x 1000 x 25mm	EACH	<b>£3.80</b>
192528	19 x 0.25 x 1300 x 28mm	EACH	<b>£4.20</b>
192830	19 x 0.28 x 1250 x 30mm	EACH	<b>£4.20</b>
193030	19 x 0.30 x 1250 x 30mm	EACH	<b>£4.20</b>
193035	19 x 0.30 x 1550 x 35mm	EACH	<b>£4.60</b>
193440	19 x 0.34 x 1650 x 40mm	EACH	<b>£6.25</b>
193535	19 x 0.35 x 1400 x 35mm	EACH	<b>£4.60</b>
193545	19 x 0.35 x 2200 x 45mm	EACH	<b>£6.25</b>
194040	19 x 0.40 x 1500 x 40mm	EACH	<b>£6.25</b>
194045	19 x 0.40 x 1700 x 45mm	EACH	<b>£6.25</b>
194132	19 x 0.41 x 951 x 32mm 400 Day, Horolovar	EACH	<b>£17.95</b>
194132AA	19 x 0.41 x 951 x 32mm 400 Day, Trifix	EACH	<b>£6.95</b>
194138	19 x 0.41 x 1346 x 38mm 400 Day, Horolovar	EACH	<b>£17.95</b>
M42415	19 x 0.41 x 1346 x 38mm 400 Day, Trifix	EACH	<b>£6.95</b>
194336	19 x 0.43 x 1143 x 36mm 400 Day, Horolovar	EACH	<b>£17.95</b>
194336A	19 x 0.43 x 1143 x 36mm 400 Day, Trifix	EACH	<b>£7.50</b>
194536	19 x 0.45 x 1200 x 36mm	EACH	<b>£6.25</b>
194545	19 x 0.45 x 1650 x 45mm	EACH	<b>£5.95</b>
195545	19 x 0.55 x 1600 x 45mm	EACH	<b>£6.25</b>
202525	20 x 0.25 x 1000 x 25mm	EACH	<b>£4.20</b>
202530	20 x 0.25 x 1350 x 30mm	EACH	<b>£6.25</b>
203020	20 x 0.30 x 550 x 20mm	EACH	<b>£4.20</b>
203030	20 x 0.30 x 1250 x 30mm	EACH	<b>£5.25</b>
203035	20 x 0.30 x 1550 x Ø35mm	EACH	<b>£6.25</b>
203531	20 x 0.35 x 1100 x 31mm	EACH	<b>£6.25</b>
203535	20 x 0.35 x 1400 x 35mm	EACH	<b>£6.25</b>
203540	20 x 0.35 x 1600 x 40mm	EACH	<b>£9.20</b>
204035	20 x 0.40 x 1100 x 35mm	EACH	<b>£6.25</b>
204040	20 x 0.40 x 1500 x 40mm	EACH	<b>£9.20</b>
204045	20 x 0.40 x 1700 x 45mm	EACH	<b>£9.20</b>
204138	20 x 0.41 x 1346 x 38mm 400 Day, Horolovar	EACH	<b>£17.95</b>
204138A	20 x 0.41 x 1346 x 38mm 400 Day, Trifix	EACH	<b>£9.95</b>
204545	20 x 0.45 x 1650 x 45mm	EACH	<b>£7.75</b>
212830	21 x 0.28 x 1250 x 30mm	EACH	<b>£6.25</b>
213030	21 x 0.30 x 1250 x 30mm	EACH	<b>£5.25</b>
213035	21 x 0.30 x 1550 x 35mm	EACH	<b>£6.25</b>
213535	21 x 0.35 x 1400 x 35mm	EACH	<b>£6.25</b>
213540	21 x 0.35 x 1600 x 40mm	EACH	<b>£7.50</b>
213545	21 x 0.35 x 1650 x 45	EACH	<b>£7.50</b>
213850	21 x 0.38 x 1780 x 50mm 400 Day, Horolovar	EACH	<b>£25.25</b>
213850A	21 x 0.38 x 1780 x 50mm 400 Day, Trifix	EACH	<b>£12.75</b>
214040	21 x 0.40 x 1550 x 40mm	EACH	<b>£7.70</b>
214041	21 x 0.40 x 1550 x 41mm (to fit Hermle barrel 41)	EACH	<b>£8.65</b>
214045	21 x 0.40 x 1700 x 45mm	EACH	<b>£7.50</b>
214050	21 x 0.40 x 2100 x 50mm	EACH	<b>£11.95</b>
214246	21 x 0.42 x 1900 x 46mm (to fit Hermle barrel 54)	EACH	<b>£10.75</b>
214545	21 x 0.45 x 1650 x 45mm	EACH	<b>£7.95</b>
214565	21 x 0.45 x 2900 x 65mm	EACH	<b>£18.95</b>
222530	22 x 0.25 x 1350 x 30mm	EACH	<b>£6.25</b>
223030	22 x 0.30 x 1250 x 30mm	EACH	<b>£6.25</b>
223035	22 x 0.30 x 1550 x 35mm	EACH	<b>£6.95</b>
223535	22 x 0.35 x 1400 x 35mm	EACH	<b>£6.95</b>
224040	22 x 0.40 x 1500 x 40mm	EACH	<b>£7.95</b>
224045	22 x 0.40 x 1700 x 45mm	EACH	<b>£7.95</b>
224545	22 x 0.45 x 1700 x 45mm	EACH	<b>£7.95</b>
224555	22 x 0.45 x 2400 x 55mm	EACH	<b>£11.95</b>
225050	22 x 0.50 x 1900 x 50mm	EACH	<b>£11.95</b>
226055	22 x 0.60 x 2200 x 55mm	EACH	<b>£11.95</b>
226057	22 x 0.60 x 2700 x 57mm	EACH	<b>£15.85</b>
233030	23 x 0.30 x 1250 x 30mm	EACH	<b>£6.25</b>
233548	23 x 0.35 x 2450 x 48mm	EACH	<b>£12.95</b>
234348	23 x 0.43 x 1800 x 48mm	EACH	<b>£12.95</b>
234545	23 x 0.45 x 1650 x 45mm	EACH	<b>£9.20</b>
243030	24 x 0.30 x 1250 x 30mm	EACH	<b>£6.25</b>
244040	24 x 0.40 x 1500 x 40mm	EACH	<b>£7.95</b>
244045	24 x 0.40 x 1700 x 45mm	EACH	<b>£9.20</b>
244050	24 x 0.40 x 2200 x 50mm	EACH	<b>£12.10</b>
244545	24 x 0.45 x 1650 x 45mm	EACH	<b>£7.95</b>

244550	24 x 0.45 x 2000 x 50mm	EACH	<b>£12.10</b>
245050	24 x 0.50 x 1900 x 50mm	EACH	<b>£12.10</b>
245055	24 x 0.50 x 2400 x 55mm	EACH	<b>£12.10</b>
253030	25 x 0.30 x 1250 x 30mm	EACH	<b>£9.20</b>
253535	25 x 0.35 x 1400 x 35mm	EACH	<b>£9.20</b>
254040	25 x 0.40 x 1500 x 40mm	EACH	<b>£11.95</b>
254050	25 x 0.40 x 2100 x 50mm	EACH	<b>£15.85</b>
254545	25 x 0.45 x 1650 x 45mm	EACH	<b>£10.95</b>
254550	25 x 0.45 x 2000 x 50mm	EACH	<b>£15.00</b>
255050	25 x 0.50 x 1900 x 50mm	EACH	<b>£12.10</b>
256050	25 x 0.60 x 1850 x 50mm	EACH	<b>£15.85</b>
256055	25 x 0.60 x 2100 x 55mm	EACH	<b>£15.85</b>
256057	25 x 0.60 x 2800 x 57mm	EACH	<b>£18.70</b>
264545	26 x 0.45 x 1650 x 45mm	EACH	<b>£10.95</b>
264550	26 x 0.45 x 2100 x 50mm	EACH	<b>£15.85</b>
274545	27 x 0.45 x 1650 x 45mm	EACH	<b>£10.95</b>
283545	28 x 0.35 x 1850 x 45mm	EACH	<b>£10.95</b>
284045	28 x 0.40 x 1700 x 45mm	EACH	<b>£10.95</b>
284050	28 x 0.40 x 2000 x 50mm	EACH	<b>£15.85</b>
284550	28 x 0.45 x 2000 x 50mm	EACH	<b>£15.85</b>
294565	29 x 0.45 x 2500 x 65mm	EACH	<b>£15.85</b>
304045	30 x 0.40 x 1700 x 45mm	EACH	<b>£11.95</b>
304050	30 x 0.40 x 2200 x 50mm	EACH	<b>£18.50</b>
305062	30 x 0.50 x 2650 x 62mm	EACH	<b>£29.95</b>
324045	32 x 0.40 x 1700 x 45mm	EACH	<b>£18.50</b>
324050	32 x 0.40 x 2200 x 50mm	EACH	<b>£18.50</b>
324055	32 x 0.40 x 2500 x 55mm	EACH	<b>£18.95</b>
324551	32 x 0.45 x 2100 x 51mm	EACH	<b>£18.95</b>
354545	35 x 0.45 x 1700 x 45mm	EACH	<b>£18.95</b>
354547	35 x 0.45 x 1700 x 47mm	EACH	<b>£23.95</b>
354550	35 x 0.45 x 2000 x 50mm	EACH	<b>£23.95</b>
354555	35 x 0.45 x 2400 x 55mm	EACH	<b>£23.95</b>
355050	35 x 0.50 x 1900 x 50mm	EACH	<b>£25.95</b>
384050	38 x 0.40 x 2000 x 50mm	EACH	<b>£25.95</b>
384548	38 x 0.45 x 1800 x 48mm	EACH	<b>£25.95</b>
384550	38 x 0.45 x 2000 x 50mm	EACH	<b>£25.95</b>
384555	38 x 0.45 x 2500 x 55mm	EACH	<b>£27.65</b>
384557	38 x 0.45 x 2550 x 57mm	EACH	<b>£29.95</b>
385060	38 x 0.50 x 2000 x 60mm	EACH	<b>£29.95</b>
385560	38 x 0.55 x 2750 x 60mm	EACH	<b>£35.95</b>
404550	40 x 0.45 x 2000 x 50mm	EACH	<b>£29.95</b>
404555	40 x 0.45 x 2500 x 55mm	EACH	<b>£29.95</b>
405050	40 x 0.50 x 1900 x 50mm	EACH	<b>£29.95</b>
404558	40 x 0.45 x 2800 x 58mm	EACH	<b>£38.35</b>
455050	45 x 0.50 x 1900 x 50mm	EACH	<b>£38.35</b>
505055	50 x 0.50 x 2400 x 55mm	EACH	<b>£39.95</b>
505060	50 x 0.50 x 2500 x 60mm	EACH	<b>£41.95</b>

Price breaks available, see website

**LOOSE LOOP (TRIFIX) CLOCK MAINSPRINGS**

**Loose Loop (Alarm Clock)**



**Loose Loop Trifix Clock Mainsprings**

- Alarm clock, 30 hour
- Loop end
- The famous Trifix "Fix" brand mainsprings
- Best quality
- Sizes in millimetres

Dimensions: Height x Thickness (Strength) x Length

Code	Description	UOM	Price
325650LL	3 x 0.25 x 650mm	EACH	<b>£2.80</b>
330750LL	3 x 0.30 x 750mm	EACH	<b>£2.80</b>
3520750LL	3.5 x 0.20 x 750mm	EACH	<b>£2.80</b>
3525750LL	3.5 x 0.25 x 750mm	EACH	<b>£2.80</b>
423700LL	4 x 0.23 x 700mm	EACH	<b>£2.80</b>
425750LL	4 x 0.25 x 750mm	EACH	<b>£2.80</b>
430700LL	4 x 0.30 x 700mm	EACH	<b>£2.80</b>
435750LL	4 x 0.35 x 750mm	EACH	<b>£2.80</b>
4525750LL	4.5 x 0.25 x 750mm	EACH	<b>£2.80</b>
4530500LL	4.5 x 0.30 x 500mm	EACH	<b>£2.80</b>
5201100LL	5 x 0.20 x 1100mm	EACH	<b>£2.80</b>
5251100LL	5 x 0.25 x 1100mm	EACH	<b>£2.80</b>
525750LL	5 x 0.25 x 750mm	EACH	<b>£2.80</b>
5281000LL	5 x 0.28 x 1000mm	EACH	<b>£2.80</b>
530750LL	5 x 0.30 x 750mm	EACH	<b>£2.80</b>
530800EE	5 x 0.30 x 800mm (Eye End)	EACH	<b>£2.80</b>
5321000LL	5 x 0.32 x 1000mm	EACH	<b>£2.80</b>
540750LL	5 x 0.40 x 750mm	EACH	<b>£2.80</b>
5525750LL	5.5 x 0.25 x 750mm	EACH	<b>£2.80</b>
5530750LL	5.5 x 0.30 x 750mm	EACH	<b>£2.80</b>
55361000LL	5.5 x 0.36 x 1000mm	EACH	<b>£2.80</b>
625850LL	6 x 0.25 x 850mm	EACH	<b>£2.80</b>
630900LL	6 x 0.30 x 900mm	EACH	<b>£2.80</b>
635900LL	6 x 0.35 x 900mm	EACH	<b>£2.80</b>
6401000LL	6 x 0.40 x 1000mm	EACH	<b>£2.80</b>
65201000LL	6.5 x 0.20 x 1000mm	EACH	<b>£2.95</b>
6525750LL	6.5 x 0.25 x 750mm	EACH	<b>£2.95</b>
65321000LL	6.5 x 0.32 x 1000mm	EACH	<b>£2.95</b>
6532750LL	6.5 x 0.32 x 750mm	EACH	<b>£2.95</b>
7201000LL	7 x 0.20 x 1000mm	EACH	<b>£2.95</b>
7301000LL	7 x 0.30 x 1000mm	EACH	<b>£2.95</b>
740900LL	7 x 0.40 x 900mm	EACH	<b>£2.95</b>
7520650LL	7.5 x 0.20 x 650mm	EACH	<b>£2.95</b>
7525750LL	7.5 x 0.25 x 750mm	EACH	<b>£2.95</b>
75301100LL	7.5 x 0.30 x 1100mm	EACH	<b>£2.95</b>
75301100EE	7.5 x 0.30 x 1100mm (Eye End)	EACH	<b>£2.95</b>
75321100LL	7.5 x 0.32 x 1100mm	EACH	<b>£2.95</b>
7532850LL	7.5 x 0.32 x 850mm (Smiths)	EACH	<b>£2.95</b>
75361200LL	7.5 x 0.36 x 1200mm	EACH	<b>£2.95</b>
75401100LL	7.5 x 0.40 x 1100mm	EACH	<b>£2.95</b>
825750LL	8 x 0.25 x 750mm	EACH	<b>£2.95</b>
830700LL	8 x 0.30 x 700mm (Westclox)	EACH	<b>£2.95</b>
8401300LL	8 x 0.40 x 1300mm	EACH	<b>£2.95</b>
925850LL	9 x 0.25 x 850mm	EACH	<b>£3.25</b>
930700LL	9 x 0.30 x 700mm	EACH	<b>£3.25</b>
9311100LL	9 x 0.31 x 1100mm	EACH	<b>£3.25</b>
9401100LL	9 x 0.40 x 1100mm	EACH	<b>£3.25</b>
9451100LL	9 x 0.45 x 1100mm	EACH	<b>£3.25</b>

**Clock Mainspring Tool**



See Page: 918

**Pocket Size Multi Purpose Oiler**

See Page 1182





10301100LL	10 x 0.30 x 1100mm	EACH	£4.50
10401100LL	10 x 0.40 x 1100mm	EACH	£4.50
12302500	12 x 0.30 x 2500mm	EACH	£4.50

Price breaks available, see website

## CLOCK MAINSPRING CONTAINMENT RINGS

### Mainspring Containment Rings (Clock)



Clock Mainspring Containment Rings

- Set of 4
- Internal Ø: 29mm, 39mm, 49mm & 63mm

Code	Description	UOM	Price
M32020	Clock Mainspring Containment Rings	PACK*4	£6.95

## MOVEMENT PARTS, ENGLISH, FRENCH & LONGCASE

All Longcase parts are generic parts for Longcase Clocks and may need adapting to fit.

- Back Cocks
- Conversion Chain Kits
- Crutch, Flat Shank
- Crutch, Rounded Shank
- Date Wheels
- Escape Wheels
- Escapement Set (with 1¼" Centres)
- Escapement Set (with 1½" Centres)
- Fly Blanks
- Friction Spring
- Hour Wheel / Cannon Pinion Bridge
- Minute Wheel Post / Stud
- Pinion Blanks
- Rack Blanks
- Rack Hook & Lifting Piece Stud
- Rack Spring
- Rack Stud
- Wheel Collets

### Back Cocks (Long Case)



Long Case Clock - Back Cocks

- Brass
- Slotted for suspension

- High quality fabricated back cock
- Single arm to suit earlier movements
- Supplied blank so you can create fixing holes where you need to
- Made in Great Britain

• Item L33582  
High quality lost wax cast Back Cock with a single arm to suit earlier movements. Fixing foot manufactured from 3.2mm brass plate. Very little finishing required.

• Item L37754  
High quality lost wax cast back cock, with twin arms. Cast with 3.2 mm brass section, pre machined with a slot to take the clock suspension.

• Item L5099  
High quality back cock, with twin arms. Made with 4.25mm brass section, pre machined with a straight slot to take the clock suspension.

Code	Description	UOM	Price
L33582	Long Case Back Cock, Single Arm	EACH	£17.50
L37754	Long Case Back Cock, Twin Arms	EACH	£19.95
L5099	Long Case Back Cock, Twin Arms	EACH	£17.50

### Conversion Chain Kits (Long Case)



Long Case - Chain & Sprocket Sets - Conversion Sets

• Chain & Sprocket Set, Budget (L33581)  
Long Case Chain & Steel Sprocket Kit. This Chain & sprocket set can be used as an inexpensive way of solving the problem of worn sprockets & stretched or mismatched chains. This set will also fit straight onto any our old or worn budget conversion sets. Made in UK

• Chain & Sprocket Set (L33579)  
Long Case Chain & Brass Sprocket Set. A reliable, convenient, & inexpensive way of solving the problem of worn, or mismatched chain & sprockets, on thirty hour clocks, which can cause the chain to jump & slip. Made in UK

• Conversion Set, Budget (L0909)  
Long Case Chain Conversion Set with Brass Click. Well engineered, great value Conversion Set, with pressed steel sprockets & triangular brass click. Ideal for later, less expensive movements. Made in UK

• Conversion Set (L33580)  
Long Case Chain Conversion Set with Circular Steel Click. This is a high quality Conversion Set manufactured to suit early or high quality movements. Made in UK

Code	Description	UOM	Price
L33579	Chain & Brass Sprocket Set	EACH	£21.65
L33581	Chain & Steel Sprocket Set, Budget	EACH	£15.25
L33580	Conversion Set	EACH	£61.75
L0909	Conversion Set, Budget	EACH	£33.95

### Crutch (English Dial), Blank



English Dial, Fusee - Crutch Blank

- Brass
- Made in UK or India

Code	Description	UOM	Price
C47712	Fusee Crutch Blank	EACH	£1.95

C8842	Fusee Crutch Blank, UK	EACH	£3.85
-------	------------------------	------	-------

### Crutch (French Clock), Blank



French Clock - Crutch Blank

- Pressed brass
- 1.5mm thick
- To suit French clocks
- Made in UK

Code	Description	UOM	Price
F6232	French Clock - Crutch Blank	EACH	£2.45

### Crutch (Long Case), Flat Shank



Long Case Clock - Crutch - Flat Profile Shank

Longcase Crutch Blank one piece pressing, manufactured from 2.00mm bright Steel. This crutch can be made to look very convincing, with some work.

Dimensions:

- Total Length 139mm approx
- Distance from centre of pallet arbour boss to centre of slot 116.5mm
- Slot 19.15mm x 4.65mm
- Made in UK

Code	Description	UOM	Price
L4813	Long Case Crutch, Flat	EACH	£5.50

### Crutch (Long Case), Rounded Shank



Long Case Clock - Crutch - Rounded Shank

Composite crutch for Long Case clocks. Built from three pieces with a 2mm pliable shank & a 4.40mm wide slot for the suspension block. This type of Crutch requires little final finishing.

L39709

- Total length 152mm
- Slot 17 x 4.4mm

L0910

- Total length 132mm
- Slot 17 x 4.4mm

Code	Description	UOM	Price
L39709	Long Case Crutch, Rounded	EACH	£3.95
L0910	Long Case Crutch, Rounded	EACH	£9.60

### Date Wheels (Long Case)

Long Case Clock - Date Wheels

- Date or Calendar Wheels
- Long case / Grandfather Clocks
- Brass CZ120 Sheet
- 1.5mm Thick
- Made in UK
- Teeth Count: 48, 56 & 60
- Wheel Diameters: Ø42 to Ø59mm
- Bore Size: 4mm



Dimensions: Teeth Count x (Wheel Ø)

Code	Description	UOM	Price
L34670	48 Teeth (Ø50mm) Wheel	EACH	£25.85
L34671	48 Teeth (Ø51mm) Wheel	EACH	£25.85
L34672	48 Teeth (Ø52mm) Wheel	EACH	£25.85

L34673	48 Teeth (Ø54mm) Wheel	EACH	£25.85
L34674	56 Teeth (Ø42mm) Wheel	EACH	£25.85
L34675	56 Teeth (Ø47mm) Wheel	EACH	£25.85
L34676	56 Teeth (Ø48mm) Wheel	EACH	£25.85
L34677	56 Teeth (Ø49mm) Wheel	EACH	£25.85
L34524	56 Teeth (Ø50mm) Wheel, Popular	EACH	£25.85
L39296	60 Teeth (Ø42mm) Wheel	EACH	£25.85
L34678	60 Teeth (Ø43mm) Wheel	EACH	£25.85
L34679	60 Teeth (Ø44mm) Wheel	EACH	£25.85
L34680	60 Teeth (Ø45mm) Wheel	EACH	£25.85
L34681	60 Teeth (Ø47mm) Wheel	EACH	£25.85
L34682	60 Teeth (Ø52mm) Wheel	EACH	£25.85
L34683	60 Teeth (Ø53mm) Wheel	EACH	£25.85
L34684	60 Teeth (Ø58mm) Wheel	EACH	£25.85
L34685	60 Teeth (Ø59mm) Wheel	EACH	£25.85

**Escapement Set (with 1½" Centres) (Long Case)**



**Longcase Escapement Set (with 1½" Centres)**

This set is suited to earlier movements with a small escape wheel and a narrow swing on the pendulum.

Contains:

- 1 x Ø39mm, 30 Tooth Escape Wheel (our code L8874)
- 1 x Set of Ground & Polished Pallets to Suit (our code L34559)
- 2 x Brass Wheel Collets (our code L17724)
- 1 x Centre Punched Strip, to be used to set the correct depth on your depthing tool

Made in UK

Code	Description	UOM	Price
L8873	Escapement Set (with 1½" Centres)	EACH	£66.65

**Fly Blanks (Long Case)**

**Long Case Clock - Fly Blanks**



A high quality fabricated fly blank requiring very little finishing. Manufactured from .75mm brass sheet, with pilot holes drilled in the centres.

Dimensions:

- 38mm x 26mm
- 42mm x 29mm

Made in UK

Code	Description	UOM	Price
L13732	38 x 26mm Fly Blank	EACH	£8.95
L13731	42 x 29mm Fly Blank	EACH	£9.95

**Friction Spring (Long Case)**

**Long Case Clock - Friction Spring**



- Brass
- For motion work
- Square or round hole
- Slightly convex

Dimensions (approx.): 12 x 27mm

Code	Description	UOM	Price
L38762	Long Case Friction Spring, Indian	EACH	£0.95
L0911	Long Case Friction Spring, UK	EACH	£1.60
L40261	Long Case Friction Spring, UK, Round Hole	EACH	£1.60

**Escape Wheels (Long Case)**

**Long Case Clock - Escape Wheels**

Longcase 30 teeth escape wheel cut, crossed out & bored. Supplied with mounting collet, wheel diameters in sizes from 36mm, rising to 45mm in 1mm increments.



- Brass
- Diameter measured across tooth tips
- Ø36mm to Ø45mm
- 30 teeth
- UK Made

Code	Description	UOM	Price
L37755	Ø36mm Escape Wheel	EACH	£23.50
L37756	Ø37mm Escape Wheel	EACH	£23.50
L37757	Ø38mm Escape Wheel	EACH	£23.50
L8874	Ø39mm Escape Wheel	EACH	£23.50
L37758	Ø40mm Escape Wheel	EACH	£23.50
L8875	Ø41mm Escape Wheel	EACH	£23.50
L37759	Ø42mm Escape Wheel	EACH	£23.50
L8876	Ø43mm Escape Wheel	EACH	£23.50
L37760	Ø44mm Escape Wheel	EACH	£23.50
L8877	Ø45mm Escape Wheel	EACH	£23.50

**Escapement Set (with 1¼" Centres) (Long Case)**



**Longcase Escapement Set (with 1¼" Centres)**

This set is suited to later clocks which use a larger escape wheel and shallower pallets.

Contains:

- 1 x Ø44mm, 30 Tooth Escape Wheel (our code L37760)
- 1 x Set of Ground & Polished Pallets to Suit (our code L48772)
- 2 x Brass Wheel Collets (our code L17724)
- 1 x Centre Punched Strip, to be used to set the correct depth on your depthing tool

Made in UK

Code	Description	UOM	Price
C34653	Escapement Set (with 1¼" Centres)	EACH	£66.95

**Hour Wheel / Cannon Pinion Bridge (Long Case)**



**Long Case Clock - Hour Wheel / Cannon Pinion Bridge**

Cannon pinion bridge fitted with a Ø9mm pipe extension for the hour wheel

- Brass
- 70 x 30 x 12mm (overall width x overall height x depth)
- Ø9mm pipe outer diameter
- Ø6.30mm pipe internal diameter
- 22mm pipe length
- With (drilled) or without mounting holes (non-drilled)
- Mounting holes on drilled version 56.75mm (centre distance of the mounting holes)
- Made in UK

Code	Description	UOM	Price
L0917	Hour Wheel/Cannon Pinion Bridge, Drilled	EACH	£19.95
L47817	Hour Wheel/Cannon Pinion Bridge, Non-drilled	EACH	£19.75

**Minute Wheel Post / Stud (Long Case)**

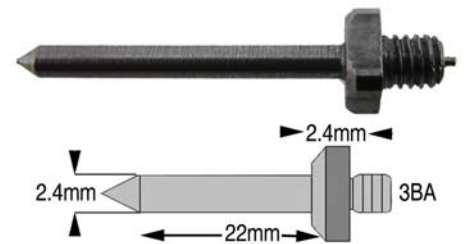

**Long Case Clock - Minute Wheel Post / Stud**

The mounting part of the Stud is threaded 3BA, with the opposite end turned to a point to enable the stud to be held in a lathe to aid final finishing. Made from one piece, ¼" Steel square section.

Manufactured with a thinner shoulder and shaft making it Ideal for mounting the minute wheel & pinion on antique Longcase clocks.

- Steel
- Post Length 22mm
- Post Ø2.4mm
- 3BA screw thread (Ø4.10mm)
- Made in Great Britain

Code	Description	UOM	Price
L34552	Minute Wheel Post / Stud	EACH	£4.15

**Pinion Blanks (Long Case)**

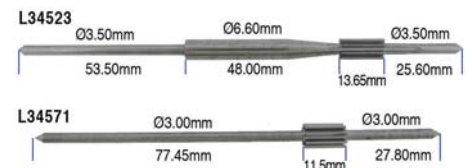

**Long Case Clock - Pinion Blanks**

Both the centre wheel pinion and the standard train wheel pinion are manufactured from EN8DM, free cutting medium carbon steel. Both manufactured with a generous length dimension allowing them to be cut and machined to fit

- Centre Pinion is designed to be more than long enough for most Longcase clocks



**MOVEMENT PARTS, HERMLE (BY LIST)**



Movement part required:

If you require a movement part which is not listed below you can request a quote via our Hermle movement parts search category by searching and selecting the part required in the Hermle PDF Diagram Number look up and then add it as a non listed item, you will need to provide the pendulum length you require in the description field.

All Hermle part sheets that are available from Hermle are in our document download area

**Barrel Arbors**

Hermle Barrel Arbors

- Calibres ending in 021 = HERE00502370
- Calibres ending in 020 = HERE00500270
- Calibres ending in 023 = HERB02606972



E005.066901 for Hermle calibre 791.081

Code	Description	UOM	Price
HERE00502370	B026.06652 (E005.02370) Overall Length 53.70mm	EACH	£5.95
HERE00500270	B026.06612 Overall Length 58.55mm	EACH	£5.95
HERB02606972	B026.06972 Overall Length 74.10mm	EACH	£5.95
HERE005066901	E005.066901 Arbor without Ratchet Wheel	EACH	£3.25

**Barrels Complete**



Hermle Clock Barrels

- Genuine Hermle Barrels Complete
- Barrels complete with arbor and mainspring
- Factory part No. is usually stamped on original barrel
- Hermle Clock Movement Service Manual: Item Number H31543

Barrel mainspring sizes:

- No.10 = 17 x 0.45 x 1490 x Ø42mm
- No.11 = 17 x 0.42 x 1500 x Ø42mm
- No.21 & 20 = 17 x 0.40 x 1200 x Ø38mm
- No.31 = 12 x 0.34 x 1150 x Ø34mm
- No.32 & 30 = 12 x 0.44 x 1100 x Ø34mm
- No.33 = 12 x 0.32 x 1150 x Ø34mm
- No.40 & 42 = 17 x 0.38 x 1100 x Ø35mm
- No.41 = 21 x 0.40 x 1550 x Ø41mm

- Standard Pinion is designed to fit the vast majority of antique clocks
- 8 leaf
- Ø7.0mm
- Made in UK

Code	Description	UOM	Price
L34523	Centre Pinion Blank	EACH	£49.65
L34571	Standard Pinion Blank	EACH	£37.65

**Rack Blanks (Long Case)**



Long Case Clock - Rack Blanks

- Steel
- With or Without Teeth
- I45738 & L34549:
- Longcase Rack Blank with pre-cut teeth
- Useful for clock makers making their own Longcase movements
- 84mm long
- 60mm wide
- 70mm from centre of mounting hole to tip of teeth
- Made in UK
- L45739 & L0921:
- Pressed blank ready to finish
- 84mm long
- 60mm wide
- Made in UK or India

Code	Description	UOM	Price
L45738	Rack Blank with Machined Teeth	EACH	£2.50
L34549	Rack Blank with Machined Teeth, UK	EACH	£16.25
L45739	Rack Blank without Teeth	EACH	£2.50
L0921	Rack Blank without Teeth, UK	EACH	£3.25

Price breaks available, see website

**Rack Spring (Long Case)**



Long Case Clock - Rack Spring

- Brass long case rack spring with a drilled comma foot head.
- Brass
  - Comma foot
  - Drilled
  - Overall length: 140mm (approx.)

Code	Description	UOM	Price
L38765	Long Case Rack Spring, Indian	EACH	£1.50
L0922	Long Case Rack Spring	EACH	£5.50

**Moebius Clock Oil**

**See Page 1182**

**Rack Stud (Long Case)**

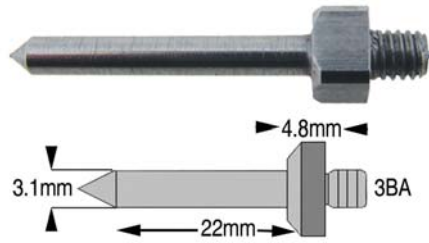

Long Case Clock - Rack Stud

The mounting part of the Stud is threaded 3BA, with the opposite end turned to a point to enable the stud to be held in a lathe to aid final finishing. Made from one piece, ¼" Steel square section.

- Steel
- Post Length 22mm
- Post Ø3.1mm
- 3BA screw thread
- Made in UK

Code	Description	UOM	Price
L34553	Long Case Rack Stud	EACH	£4.15

**Rack Stud, Hook & Lifting Piece (Long Case)**

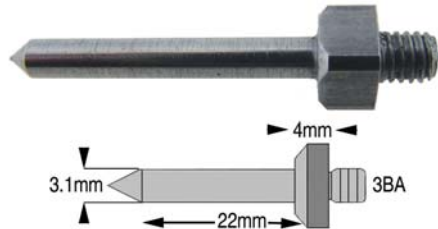

Long Case Clock - Rack Hook & Lifting Piece Stud

The mounting part of the Stud is threaded 3BA, with the opposite end turned to a point to enable the stud to be held in a lathe to aid final finishing. Made from one piece, ¼" Steel square section.

- Steel
- Post Length 22mm
- Post Ø3.1mm
- 3BA screw thread
- Made in UK

Code	Description	UOM	Price
L34551	Rack Hook & Lifting Piece Stud	EACH	£4.25

**Stop Arm (English Dial)**



English Dial, Fusee - Stop Arm

- Length 53mm (approx)
- Carbon Steel

Code	Description	UOM	Price
P34568	English Dial, Fusee Stop Arm	EACH	£4.50

**Wheel Collets (Long Case)**

Long Case Clock - Wheel Collets

- Suitable for Train & Escape Wheels
- Brass
- Pilot Hole
- Pack of 5



Code	Description	UOM	Price
L17724	Long Case Wheel Collets	PACK*5	£3.60

# MOVEMENT PARTS, HERMLE (BY LIST)

- No.50 = 17 x 0.40 x 1200 x Ø38mm
- No.52 = 17 x 0.42 x 1200 x Ø38mm
- No.54 = 21 x 0.42 x 1900 x Ø46mm
- No.55 = 17 x 0.45 x 1800 x Ø46mm
- No.56 = 17 x 0.38 x 1200 x Ø38mm

Code	Description	UOM	Price
H8228	B013.90100 Hermle Barrel No.10	EACH	£24.95
H8234	B013.90110 Hermle Barrel No.11	EACH	£24.95
H8229	B013.90210 Hermle Barrel No.21 & 20	EACH	£24.95
H8235	B013.90312 Hermle Barrel No.31	EACH	£24.95
H12392	B013.90322 Hermle Barrel No.31 & 32 (with threaded winding arbor)	EACH	£24.95
H8230	B013.90320 Hermle Barrel No.32 & 30	EACH	£24.95
H8236	B013.90332 Hermle Barrel No.33	EACH	£24.95
H8231	B013.90400 Hermle Barrel No.40 & 42	EACH	£24.95
H8237	B013.90410 Hermle Barrel No.41	EACH	£24.95
H8232	B013.90500 Hermle Barrel No.50	EACH	£24.95
H8870	B013.90520 Hermle Barrel No.52	EACH	£24.95
H8238	B013.90540 Hermle Barrel No.54	EACH	£24.95
H8233	B013.90550 Hermle Barrel No.55	EACH	£24.95
H8239	B013.90560 Hermle Barrel No.56	EACH	£24.95

## Balances

Hermle Balances

- Calibre 130 series = (2)
- Calibre 140 series = (1)
- Calibre 150 series = (1)
- Calibre 340 series = (1)
- Calibre 350 series = (1)
- Calibre 1050 series = (1)



Code	Description	UOM	Price
H8224	B019.00080 Hermle Balance Unit (1)	EACH	£43.95
H8226	B019.00090 Hermle Balance Unit (2)	EACH	£38.80

## Blind Plates & Mounting Boards



Hermle Blind Plates & Mounting Boards

Code	Description	UOM	Price
HERB02806710	B028.06710 Hermle 130.070 Blind Plate	EACH	£13.50
H9461	B028-00400 Hermle 132.071 (Ø90mm) Blind Plate	EACH	£10.70
H9462	B028.00630 Hermle 132.071 (Ø108mm) Blind Plate	EACH	£13.30
H8211	B028.01370 Hermle 451.050 & 451.053 Blind Plate	EACH	£5.95
H8214	B028.01510 Hermle 1151.050 & 1151.053 Blind Plate	EACH	£6.95
H8212	E240.00490 Hermle 451.053 & 1151.053 Mounting Board	EACH	£26.95

## Bridges, Cocks & Plates

B015.01120: Hermle Bridge (Gangbrücke)

- Hermle 130.020 (46)
- Hermle 130.070 (46)
- Hermle 130.080 (46)



Calibre x (Hermle PDF Part Number)

Code	Description	UOM	Price
HERE00201370	E002.01370 Hermle Bridge	EACH	£3.35

## Cable Drums (B013)

Hermle Cable Drums

B013.00870: Going Side (Seiltrommel Gehwerk)

- Hermle 241.840 (10)
- Hermle 781.800S (6)



B013.00880: Strike Side (Seiltrommel Schlagwerk)

- Hermle 241.840 (11)

B013.01490: Movements with a Single Cable Drum (Seiltrommel)

- Hermle 1161.853 (17)

Calibre x (Hermle PDF Part Number)

Code	Description	UOM	Price
HERB01300870	B013.00870 Hermle Cable Drum (Going Side)	EACH	£50.25
HERB01300880	B013.00880 Hermle Cable Drum (Strike Side)	EACH	£43.10
HERB01301490	Seiltrommel (No. 17), Hermle 1161.853	EACH	£41.80

## Cable Guards

Hermle Cable Guards

E018.01760: (Sperrkegeleine)

- Hermle 471.850 (86)



Calibre x (Hermle PDF Part Number)

Code	Description	UOM	Price
HERE01801760	Cable Guard, Hermle E018-01760	EACH	£6.50

## Calendar Mechanism

Calendar Mechanisms - Hermle

Calendar mechanisms show the day of the week, the date and the month of the year



K2

- Can be used with Hermle calibre series: 141, 150, 340, 341, 350, 351, 451, 461, 1151 & 1161
- Fits to the existing movement
- Sub dials are on the clock face (see additional image)

K3

- Can be used with Hermle calibre series: 141, 150, 340 & 341
- Fits to the case, separate to the existing movement
- Sub dials are below the clock face (see additional images)

Code	Description	UOM	Price
K48359	Hermle K2 Calendar Mechanism	EACH	£39.95
K48360	Hermle K3 Calendar Mechanism	EACH	£37.95

## Online Discounts

Hermle Clock Movements

See Page 1302



## Cams, Creators & Initiators (B015)



See "More Info" for Calibres & Hermle PDF Part Numbers

Hermle Cam Initiator (Schopfer)

- B015.00020
- B015.00290

Hermle Cam Snail (Schlubscheibe)

- B015.00313

Hermle Cam Star (Auslosenocken)

- B015.00810

Hermle Cam (Fallenscheibe)

- B015.02320

Code	Description	UOM	Price
HERB01500020	B015.00020 Hermle Cam Initiator (Schopfer)	EACH	£2.00
HERB01500290	B015.00290 Hermle Cam Initiator	EACH	£4.35
HERB01500313	B015.00313 Hermle Cam Snail	EACH	£11.70
HERB01500810	B015.00810 Hermle Cam Star	EACH	£4.35
HERE00710490	B015.02320 Hermle Cam	EACH	£6.55

## Circuit Boards

Hermle Circuit Boards

- Calibre 987 = (1)
- Calibre 987M = (1)



Code	Description	UOM	Price
HERB10600701	B106.00701 Hermle Circuit Board (1)	EACH	£19.95

## Clicks

Hermle Clicks

- Calibre 130 series = (2)
- Calibre 131 series = (2)
- Calibre 132 series = (2)
- Calibre 140 series = (1)
- Calibre 141 series = (1)
- Calibre 150 series = (1)
- Calibre 151 series = (1)
- Calibre 340 series = (1)
- Calibre 341 series = (1)
- Calibre 350 series = (1)
- Calibre 351 series = (1)
- Calibre 771 series = (2)
- Calibre 791 series = (1)
- Calibre 1050 series = (1)
- Calibre 1051 series = Attached to front plate, item HERB00100630
- Calibre 1051.8 series = Attached to front plate, item H43122



Code	Description	UOM	Price
HERE00100020	E001.00020 Hermle Click (1)	EACH	£2.95
H43121	E001.04560 Hermle Click (2)	EACH	£2.95

Weight Shell Extension Piece

See Page 1371



**Click Springs**



Hermle Click Springs

- Calibre 130 series = (1)
- Calibre 131 series = (1)
- Calibre 132 series = (1)
- Calibre 140 series = (2)
- Calibre 141 series = (2)
- Calibre 150 series = (2)
- Calibre 151 series = (2)
- Calibre 340 series = (3)
- Calibre 341 series = (3)
- Calibre 350 series = (3)
- Calibre 351 series = (3)
- Calibre 771 series = (1)
- Calibre 791 series = (3)
- Calibre 1050 series = (3)
- Calibre 1051 series = (3)

Code	Description	UOM	Price
HERE00104390	E001.04390 Hermle Click Spring (1)	EACH	£2.75
H20035	E001.04400 Hermle Click Spring (2)	EACH	£1.65
HERE00104730	E001.04730 Hermle Click Spring (3)	EACH	£1.65

**Date Mechanisms**

Date Mechanism - Hermle

- All Hermle movement calibre series 150, 141, 340 & 351 can be fitted with a date mechanism
- Date mechanism allows a date hand to be used from the centre hand shaft
- Dates displayed around the minute zone on the dial (see additional image)



Code	Description	UOM	Price
K48358	Hermle K1 Date Mechanism	EACH	£9.95

**Fly**



Hour Strike Fly: (Stunden-Flugel)

- B011.00020 = Hermle 351.020, 030, 030A, 051, 850
- B011.00020 = Hermle 451.050

Chime Strike Fly: (Viertel-Flugel)

- B011.00110 = Hermle 351.020
- B011.00150 = Hermle 451.050
- B011.00170 = Hermle 1163.853

Movements with a Single Fly: (Flugel)

- B011.00130 = Hermle 261.030, 080, 080A

Calibre x (Hermle PDF Part Number)

Code	Description	UOM	Price
HERB01100020	B011.00020 Hermle Fly (Hour Strike)	EACH	£4.95
HERB01100110	B011.00110 Hermle Fly (Quarter Chime)	EACH	£4.95
HERB01100130	B011.00130 Hermle Fly	EACH	£4.95
HERB01100150	B011.00150 Hermle Fly (Quarter Chime)	EACH	£4.95
HERB01100170	B011.00170 Hermle Fly (Quarter Chime)	EACH	£4.95

**Hammer Arrangements / Sets (B016 & B018)**



Hermle Hammer Arrangement (HammerSpiel/ Stundenhammerstiel)

B018.00373:

- Hermle 351.051 (29)
- Hermle 351.850 (31)
- Hermle 451.050 (31)
- Hermle 451.053 (31)
- Hermle 451.053H (31)

B018.00770

- Hermle 340.020 (33)
- Hermle 341.020 (30)

B016.02510:

- Hermle 351.850 (60)
- Hermle 451.050 (70)
- Hermle 1051.850 (69)
- Hermle 1151.050 (73)

Calibre x (Hermle PDF Part Number)

Code	Description	UOM	Price
HERB01800373	B018.00373 Hermle Hammer Arrangement	EACH	£36.75
H29458	B018.00770 Hermle Hammer Arrangement	EACH	£34.95
HERB01602510	B016.02510 Hermle Hammer Arrangement	EACH	£14.95

**Hammer Heads (B015)**

Hermle Hammer Heads

B015.00680 & B015.00682:

- Hermle 141.031 (14)
- Hermle 141.051 (14)
- Hermle 351.051 (23)
- Hermle 451.050 (24)
- Hermle 461.050 (25)



Calibre x (Hermle PDF Part Number)

Code	Description	UOM	Price
HERB01500680	B015.00680 & B015.00682 Hermle Hammer Head	EACH	£2.25

**Hand Nuts (E008)**



Hermle Hand Nut, (Zeiger Mutter)

E008.00120(B): Black

E008.00120(G): Gold

- Hermle 130 (64), 130.020 (64), 130.070 (64), 130.080 (64)
- Hermle 131 (42), 131.030 (42), 131.080 (42)
- Hermle 132.071 (44)
- Hermle 140.010 (62), 140.070 (62), 140.080 (62)
- Hermle 141.010 (54), 141.031 (36), 141.051 (37), 141.070 (54), 141.080 (54)
- Hermle 150.010 (62), 150.070 (62), 150.080 (62)
- Hermle 151.010 (54), 151.070 (54), 151.080 (54)

- Hermle 241 (45), 241.030 (45), 241.033 (45), 241.080 (40), 241.840 (32)
- Hermle 261.030 (40), 261.080A (40)
- Hermle 340.020 (61)
- Hermle 341.020 (54)
- Hermle 350.020 (58), 350.060 (58)
- Hermle 351.020 (52), 351.051 (54)
- Hermle 451.050 (68)
- Hermle 461.050 (68), 461.853 (63)
- Hermle 781.800S (21)
- Hermle 1050.020 (66)
- Hermle 1151.050 (72)
- Hermle 1161.050 (72), 1161.853 (67)

E008.00830:

- Hermle 471.050 (62)

Calibre x (Hermle PDF Part Number)

Code	Description	UOM	Price
HERE00800120B	E008.00120 (B) Hermle Hand Nut Black	EACH	£1.65
HERE00800120G	E008.00120 (G) Hermle Hand Nut Gold	EACH	£1.65
H47915	E008.00830 Hermle Hand Nut Black	EACH	£1.65

**Impact Rollers (B017)**



Hermle Impact Roller (Schlagrolle)

B017.00071:

- Hermle 350.060 (30)
- Hermle 351.051 (28)
- Hermle 351.850 (30)
- Hermle 451.050 (30)

B017.00181:

- Hermle 461.050 (31)

Calibre x (Hermle PDF Part Number)

Code	Description	UOM	Price
HERB01700071	B017.00071 Hermle Impact Roller	EACH	£16.45
H28507	B017.00181 Hermle Impact Roller	EACH	£15.95

**Keys (Winding)**



Hermle Clock Winding Keys

- Stainless steel
- Hermle Germany
- Small winding key for Hermle calibre series; 130, 131 & 771
- Large winding key for all other Hermle calibres

Code	Description	UOM	Price
K46152	3.00mm Clock Key, Hermle	EACH	£3.95
K46153	4.00mm Clock Key, Hermle	EACH	£3.95

**INTELLIGENT DISTRIBUTION**



**Levers, Chime & Strike**



B015.02090: Hermle Strike Regulating Lever (Schlagübertragungshebel)  
 • Hermle 451.030 (20)  
 • Hermle 451.050 (18)

B015.02200 (= B015.00330): Hermle Chime Transmission Lever (Schlagübertragungshebel)  
 • Hermle 340.020 (29)  
 • Hermle 341.020 (25)

Calibre x (Hermle PDF Part Number)

Code	Description	UOM	Price
HER27165	Strike Regulating Lever, Hermle B015.02090	EACH	£2.75
HERB01502200	Shock Transmission Lever (schlagübertragungshebel) (29), Hermle B01502200	EACH	£2.75

**Levers, Connecting (E001)**



Hermle Connecting Lever (Verbindungsstück)

E001.02460:  
 • Hermle 351.020 (38)

E001.05120:  
 • Hermle 351.030 (35)  
 • Hermle 351.030A (35)  
 • Hermle 451.030 (34)  
 • Hermle 1051.030 (39)  
 • Hermle 1051.830 (45)  
 • Hermle 1151.030A (38)

Calibre x (Hermle PDF Part Number)

Code	Description	UOM	Price
HERE00102460	E001.02460 Hermle Connecting Lever	EACH	£4.35
HERE00105120	E001.05120 Hermle Connecting Lever	EACH	£2.50

**Levers, Lifting, Locking, Operating & Switching (B015)**



B015.00270: Hermle Operating Rack Lever (Einfalle)  
 • Hermle 340.020 (23)  
 • Hermle 341.020 (20)  
 • Hermle 350.020 (23), 351.060 (21)  
 • Hermle 351.020 (20), 351.030 (19), 351.051 (18)  
 • Hermle 451.030 (21), 451.050 (19)  
 • Hermle 461.050 (20), 461.853S (20)

B015.00390: Hermle Switching Lever (umschalthebel)  
 • Hermle 1050.020 (28)

B015.01120: Hermle Locking Lever (arretierhebel)  
 • Hermle 132.071 (22)

B015.02100: Hermle Lifting Lever (anrichthebel)

• Hermle 340.020 (21)

Calibre x (Hermle PDF Part Number)

Code	Description	UOM	Price
HERB01500270	B015.00270 Hermle Operating Rack Lever	EACH	£3.20
HERB01500390	B015.00390 Hermle Switching Lever	EACH	£2.95
HERB01501120	B015.01120 Hermle Locking Lever	EACH	£10.50
HER29504	B015.02100 Hermle Lifting Lever	EACH	£7.50

**Levers, Silence Shut Off**

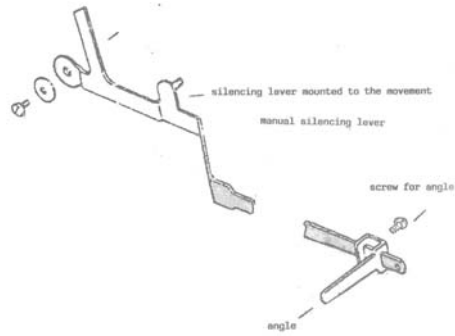

B015.00910: Chime & Strike Shut Off Lever (Abstellhebel)  
 • Hermle 451.050 (42)  
 • Hermle 1151.050 (29)

B015.01360: Hermle Chime & Strike Shut Off Lever (Umschalthebel)  
 • Hermle 471.050 (29)  
 • Hermle 471.850 (30)  
 • Hermle 1171.050 (30)  
 • Hermle 1171.850 (30)

B015.01700: Chime & Strike Shut Off Lever (Abstellhebel)  
 • Hermle 451.030 (35)  
 • Hermle 1151.030 (39)

Calibre x (Hermle PDF Part Number)

Universal Fitting Angle Levers (choice of 2, cut to required length) & Screw. Choose the angle lever closest to your requirement and cut to length.  
 • Calibre 351.030: "A" = 15.5mm  
 • Calibre 351.031: "A" = 8.5mm  
 • Calibre 351.033: "A" = 35.5mm  
 • Calibre 451.031: "A" = 8.5mm  
 • Calibre 451.033: "A" = 35.5mm  
 • Calibre 451.050: "A" = 27.5mm  
 • Calibre 451.051: "A" = 20.5mm  
 • Calibre 451.053: "A" = 47.5mm  
 • Calibre 471 Series "A" = 47.5mm  
 • Calibre 1171 Series "A" = 47.5mm  
 • Calibre Howard Miller: "A" = 41.0mm

Shut of levers prevent the movement from striking & chiming.

Code	Description	UOM	Price
H45963	B015.00910 Hermle Chime & Strike Shut Off Lever	EACH	£7.95
HERB01501360	B015.01360 Hermle Chime & Strike Shut Off Lever	EACH	£7.65
HERB01501650	27.5mm Chime & Strike Shut Off Angle Lever & Screw, Hermle B015.01650	EACH	£5.95
HERB01501690	47.5mm Chime & Strike Shut Off Angle Lever & Screw, Hermle B015.01690	EACH	£5.95
H46122	B015.01700 Hermle Chime & Strike Shut Off Lever	EACH	£7.95



**Mounting Brackets**

Hermle Mounting Bracket (Werkklappen)



E001.00061:  
 • Hermle 140.010 (39), 140.070 (39), 140.080 (39)  
 • Hermle 141.010 (32), 141.070 (32), 141.080 (32)  
 • Hermle 150.010 (39), 150.070 (39), 150.080 (39)  
 • Hermle 151.010 (32), 151.070 (32), 151.080 (32)  
 • Hermle 340.020 (40)  
 • Hermle 341.020 (36)

E001.00062:

• Hermle 140.010 (40), 140.070 (40), 140.080 (40)  
 • Hermle 141.010 (33), 141.070 (33), 141.080 (33)  
 • Hermle 150.010 (40), 150.070 (40), 150.080 (40)  
 • Hermle 151.010 (33), 151.070 (33), 151.080 (33)  
 • Hermle 340.020 (41)  
 • Hermle 341.020 (37)

Calibre x (Hermle PDF Part Number)

Code	Description	UOM	Price
HER27087	Mounting Bracket (40), Hermle E001.00061	EACH	£2.20
HER27088	Mounting Bracket (41), Hermle E001.00062	EACH	£2.20

**Dial Mounting Posts**



Clock Dial Mounting Posts

• Hermle Germany  
 • Made in Germany  
 • Dimensions: Length x diameter  
 • Can be used for any clock

H48813  
 • Hermle 141.071

H48814  
 • Hermle 140.011, 150.011, 351.021, 451.051 & 261.031

H48817  
 • Hermle 351.050S, 1051.030S, 451.030S & 1151.030S

H48820  
 • Hermle 140.010, 150.010, 261.030 & 340.020

H48819  
 • Hermle 471.050 & 1171.050

H48818  
 • Hermle 461.053S & 1161.053S

H48816  
 • Hermle 341.023, 350.033, 351.033 & 451.033

Code	Description	UOM	Price
H48813	14 x Ø5mm, Hermle E005.01610	EACH	£3.00
H48814	16 x Ø5mm, Hermle E005.01620	EACH	£3.00
H48817	18 x Ø5mm, Hermle E005.05670	EACH	£3.00
H48815	22 x Ø5mm, Hermle E005.03510	EACH	£3.00
H48820	25 x Ø5mm, Hermle E005.035101	EACH	£3.00
H48819	37 x Ø5mm, Hermle E005.07790	EACH	£3.00
H48818	38 x Ø5mm, Hermle E005.05680	EACH	£3.00
H48816	40 x Ø5mm, Hermle E005.04200	EACH	£3.00

Price breaks available, see website

**Movement Accessory Kits, Hermle**



Hermle Movement Accessory Kits

- Kits containing washers, screws, rings pins and clips
- For Hermle movements
- See additional info for full specification

Code	Description	UOM	Price
H38470	B026.07930 Hermle 271.081 Movement Accessory Kit	EACH	£29.95
H38469	B026.08320 Hermle 451.053 Movement Accessory Kit	EACH	£17.95

**Movement Plates (Back), Hermle**

Hermle Movement Back Plates

- Calibre 130 series = (1)
- Calibre 261 series = (5)
- Calibre 340 series = (2)
- Calibre 351.02 series = (3)
- Calibre 451.05 series = (4)



Code	Description	UOM	Price
HERB00100010	B001.00010 Hermle Back Plate (1)	EACH	£29.95
HERB00100530	B001.00530 Hermle Back Plate (2)	EACH	£29.95
HERB00100690	B001.00690 Hermle Back Plate (3)	EACH	£19.95
HERB00100860	B001.00860 Hermle Back Plate (4)	EACH	£25.95
HERB00101000	B001.01000/P0261.000100000 Hermle Back Plate (5)	EACH	£15.98

**Movement Plates (Front), Hermle**

Hermle Movement Front Plates

- Calibre 130 series = (4)
- Calibre 241 series = (6)
- Calibre 261 series = (3)
- Calibre 350 series = (1)
- Calibre 351 series = (1)
- Calibre 351.8 series = (2)
- Calibre 451 series = (5)
- Calibre 1050 series = (1)
- Calibre 1051 series = (1)
- Calibre 1051.8 series = (2)



Code	Description	UOM	Price
HERB00100630	B001.00630 Hermle Front Plate (1)	EACH	£29.95
H43122	B001.00850 Hermle Front Plate (2)	EACH	£19.95
HERB00101020	B001.01020 Hermle Front Plate (3)	EACH	£15.95
HERB00101320	B001.01320 Hermle Front Plate (4)	EACH	£31.25
H19836	B001.00900 Hermle Front Plate (5)	EACH	£15.95
H47760	B001.00320 Hermle Front Plate (6)	EACH	£44.95

**Night Silence Mechanisms**



Night Silence Mechanism - Hermle

All Hermle movements capable of executing a Westminster or triple chime can be equipped with the auto night shut off mechanism.

- Calibre 340 series = (1)
- Calibre 341 series = (1)
- Calibre 350 series = (1)
- Calibre 351 series = (1)
- Calibre 451 series = (1)
- Calibre 461 series = (1)
- Calibre 1050 series = (1)
- Calibre 1051 series = (1)
- Calibre 1161 series = (1)
- Calibre 1171 series = (1)

Code	Description	UOM	Price
H28917	Night Silence Mechanism, Hermle	EACH	£9.95

**Pallets**



Hermle Pallets

Hermle require the calibre as well as the length of the suspension bridge. If the calibre pallet fork is not below, you can request a quote via our Hermle movement parts search category by searching and selecting "pallet fork" in the Hermle PDF Diagram Number look up and then add it as a non listed item, you will need to provide the length of the suspension bridge you require in the description field.

Code	Description	UOM	Price
H8227	B022.00110 Hermle 130 Series Pallet	EACH	£4.50
HERB02400890	B024.00890 Hermle 141 Series Pallet	EACH	£17.40
H8225	B022.00120 Hermle 340 Series Pallet	EACH	£11.50
H20161	B024.00590 Hermle 341 Series Pallet	EACH	£16.45
H20176	B024.00320 Hermle 351 Series Pallet	EACH	£14.25
H19835	B024.00800 Hermle 451 Series Pallet	EACH	£15.95
HERB02400730	B024.00730 Hermle 791 Series Pallet	EACH	£16.20

**Pendulum Spring Lock (B026)**

Hermle Pendulum Spring Lock (Pendelfedersicherung)



- B026.01650:
- Hermle 461.050 (37)
  - Hermle 461.853S (34)
  - Hermle 471.050 (38)
  - Hermle 471.850 (41)
  - Hermle 1151.050 (40)
  - Hermle 1161.050 (37)
  - Hermle 1161.853 (36)
  - Hermle 1171.050 (39)
  - Hermle 1171.850 (41)
  - Hermle 1171.890 (53)

Calibre x (Hermle PDF Part Number)

Code	Description	UOM	Price
HER28648	B026.01650 Hermle Pendulum Spring Lock	EACH	£5.65

**Platforms**

Hermle Platforms

- Calibre 132.071 = (1)



Code	Description	UOM	Price
H9678	E028.00140 Hermle Platform (1)	EACH	£149.95

**Retaining Washers**

Hermle Retaining Washer (Sicherungsscheibe)

- E013.00580:
- Hermle 340.020 (62)
  - Hermle 341.020 (56)
  - Hermle 1151.050 (75)



- E013.00610:
- Hermle 130, 130.020, 130.070, 130.080, 130.677 (70)
  - Hermle 340.020 (63)
  - Hermle 341.020 (57)
  - Hermle 1151.050 (76)

- E013.01770:
- Hermle 261.080, 261.080A (49)

Calibre x (Hermle PDF Part Number)

Code	Description	UOM	Price
HER27090	E013.00580 Hermle Retaining Washers	EACH	£1.65
HERE01300610	E013.00610 Hermle Retaining Washer	PACK*10	£3.95
HERE01301770	E013.01770 Hermle Retaining Washer	EACH	£1.65

Price breaks available, see website

**Ratchet Spring**

Hermle Ratchet Spring



- Calibre 241 series = (1)
- Calibre 261 series = (1)
- Calibre 271 series = (1)

Code	Description	UOM	Price
HERE00105050	E001.05050 Hermle Ratchet Spring (1)	EACH	£2.75

**Rivots**

Hermle Rivot for Click

- E005.00030: (Sperrkegeiniete)
- Hermle 340.020 (50)



Calibre x (Hermle PDF Part Number)

Code	Description	UOM	Price
HERE00500030	E005.00030 Hermle Rivot for Click	EACH	£2.95



**Screws, Various & Multi Purpose**

B026.07290: Hermle Suspension Spring Screw (Pendelfederschraube)  
 • Hermle 451.050 (56)  
 • Hermle 451.053 (56)  
 • Hermle 451.053H (56)



E005.04280: Hermle Screw & Pillar (Zwischenpfeiler)  
 • Hermle 130 (52)  
 • Hermle 130.020 (52)  
 • Hermle 130.070 (52)  
 • Hermle 130.080 (52)  
 • Hermle 130.677 (52)  
 • Hermle 132.071 (36)

E006.00150: Hermle Screw (Multi Purpose)  
 • Hermle 351.020 (47)  
 • Hermle 351.030 (43)  
 • Hermle 351.030A (43)  
 • Hermle 791.680 (23)

E006.01210: Hermle Silence Shut Off Screw (Ansatzschraube)  
 • Hermle 1050.020 (61)  
 • Hermle 1051.030 (51), 1051.830 (62), 1051.850 (62)  
 • Hermle 1151.030A (50), 1151.050 (61)  
 • Hermle 1161.050 (59), 1161.853 (59)

Calibre x (Hermle PDF Part Number)

Code	Description	UOM	Price
HER29278	B026.07290 Hermle Suspension Spring Screw	EACH	£5.95
HERE00504280	E005.04280 Hermle Screw & Pillar	EACH	£2.00
HERE00600150	E006.00150 Hermle Screw (Multi Purpose)	EACH	£2.00
HERE00601210	E006.01210 Hermle Silence Shut Off Screw	EACH	£2.20

**Hermle Suspension Springs**

Hermle Suspension Springs

- Calibre 131 series = (1)
- Calibre 141 series = (1)
- Calibre 151 series = (1)
- Calibre 241 series = (1)
- Calibre 261 series = (1)
- Calibre 341 series = (1)
- Calibre 351 series = (1)
- Calibre 451.03 series = (1)
- Calibre 451.05 series = (3)
- Calibre 461 series = (3)
- Calibre 471 series = (3)
- Calibre 471.05 series = (5)
- Calibre 771 series = (1)
- Calibre 781 series = (1)
- Calibre 1051 series = (1)
- Calibre 1151.03 series = (1)
- Calibre 1151.05 series = (3)
- Calibre 1161.05 series = (6)
- Calibre 1161.85 series = (5)
- Calibre 1171.05 series = (5)
- Calibre 1171.85 series = (3)
- Calibre 1171.89 series = (5)

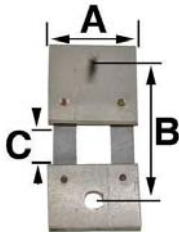

Code	Description	UOM	Price
HERE02100060	E021-00060, (1) B = 11.8mm (A = 8.0mm & C = 2.3mm)	EACH	£4.95
HERE02101000	E021-01000, (2) B = 12.0mm (A = 8.0mm & C = 3.75mm)	EACH	£4.95
H43289	E021-02480, (5) B = 14.5mm (A = 12.15mm & C = 4.1mm)	EACH	£4.95
HERE02102483	E021-02483, (3) B = 15.0mm (A = 12.2mm & C = 4.0mm)	EACH	£4.95
H43290	E021-02481, (6) B = 15.2mm (A = 12.3mm & C = 4.1mm)	EACH	£6.75

**More Suspensions**  
 See Page 1357

**Tension Springs (Helical & Straight)**

Hermle Tension Springs (Spannfeder)

E011.00070 (Straight):  
 • Hermle 241, 241.030, 241.033, 241.080 (47)  
 • Hermle 241.840 (33)



E014.00870 (Helical):  
 • Hermle 261.030 (45)  
 • Hermle 340.020 (59)  
 • Hermle 1051.830 (75)  
 • Hermle 1051.850 (73)  
 • Hermle 1151.030A (60)  
 • Hermle 1151.050 (85)  
 • Hermle 1161.050 (78)  
 • Hermle 1161.853 (74)

E014.01903 (Helical):  
 • Hermle 1051.850 (74)  
 • Hermle 1151.050 (86)  
 • Hermle 1171.050 (69)  
 • Hermle 1171.850 (79)

Calibre x (Hermle PDF Part Number)

Code	Description	UOM	Price
HERE01100070	E011.00070 Hermle Tension Spring (Straight)	EACH	£1.65
HERE01400870	E014.00870 Hermle Tension Spring (Helical)	EACH	£1.65
HER27091	E014.01903 Hermle Tension Spring (Helical)	EACH	£1.65
Price breaks available, see website			

**Washers (E001)**

Hermle Washer (Unterlagscheibe)

E001.01880:  
 • Hermle 130 (42), 130.020 (42), 130.070 (42), 130.080 (42)  
 • Hermle 131 (29), 131.030 (29), 131.080 (29)  
 • Hermle 132.071 (29)  
 • Hermle 261.030 (25)  
 • Hermle 340.020 (44)  
 • Hermle 341.020 (38)  
 • Hermle 350.020 (43), 350.060 (43)  
 • Hermle 351.020 (37), 351.030 (32), 351.051 (37), 351.850 (39)  
 • Hermle 451.030 (33), 451.050 (40)  
 • Hermle 461.050 (40), 461.853S (36)  
 • Hermle 771 (8)  
 • Hermle 781.800 (10), 781.800S (10)  
 • Hermle 1050.020 (48), 1051.030 (36), 1051.830 (41), 1051.850 (44)  
 • Hermle 1151.030A (37), 1151.050 (44)  
 • Hermle 1161.050 (40), 1161.853 (38)



Calibre x (Hermle PDF Part Number)

Code	Description	UOM	Price
HERE00101880	Unterlagscheibe (33), Hermle 451.030 E001.01880	EACH	£2.50

**Wheels B003, Minute**



Minute Wheels

Hermle require the calibre as well as the minute

wheel height. If the calibre and minute wheel height combination is not below, you can request a quote via our Hermle movement parts search category by searching and selecting "minute wheel" in the Hermle PDF Diagram Number look up and then add it as a non listed item, you will need to provide the minute wheel height you require in the description field.

Hermle calibre x (Minute wheel overall height)

Code	Description	UOM	Price
H20174	B003.00030 Hermle 130 Series (43.60mm) Minute Wheel	EACH	£11.95
H20175	B003.01300 Hermle 131 Series, 771 Series (48.30mm) Minute Wheel	EACH	£11.95
H20172	B003.01290 Hermle 131 Series, 771 Series (53mm) Minute Wheel	EACH	£11.95
H20170	B003.00194 Hermle 241 Series (68.75mm) Minute Wheel	EACH	£11.95
H20171	B003.00193 Hermle 241 Series (88.85mm) Minute Wheel	EACH	£11.95
H21876	B003.01200 Hermle 261 Series (59mm) Minute Wheel	EACH	£11.95
H20157	B003.01180 Hermle 341 Series (68.80mm) Minute Wheel	EACH	£11.95
H20177	B003.00162 Hermle 351 Series (69mm) Minute Wheel	EACH	£11.95
H20178	B003.00191 Hermle 451 Series (69mm) Minute Wheel	EACH	£11.95
H22175	B003.00830 Hermle 1151 Series (68.85mm) Minute Wheel	EACH	£11.95

**Wheels B004, Impeller (Laufrad)**

Hermle Wheel Impeller (Laufrad)



B004.00030:  
 • Hermle 130 (4)  
 • Hermle 130.020 (4), 130.070 (4), 130.080 (4)  
 • Hermle 130.677 (4)

B004.00040:  
 • Hermle 140.010 (3), 140.070 (3), 140.080 (3)  
 • Hermle 150.010 (3), 150.070 (3), 150.080 (3)  
 • Hermle 340.020 (3)  
 • Hermle 350.020 (3), 350.060 (3)  
 • Hermle 1050.020 (3)

B004.00510:  
 • Hermle 141.010, 141.040, 141.070, 141.080 (Laufrad D)  
 • Hermle 151.010, 151.070, 151.080 (Laufrad D)

B004.00920:  
 • Hermle 341.020 (Laufrad D)

Calibre x (Hermle PDF Part Number)

Code	Description	UOM	Price
HERB00400030	B004.00030 Hermle Wheel (Laufrad)	EACH	£9.85
HERB00400040	B004.00040 Hermle Wheel (Laufrad)	EACH	£10.95
HERB00400510	B004.00510 Hermle Wheel (Laufrad)	EACH	£8.75
HER341020LAUFRAD	B004.00920 Hermle Wheel (Laufrad)	EACH	£10.95

**Wheels B005, Third (Sekundenrad)**

Hermle Third Wheel (Sekundenrad)



B005.00020:  
 • Hermle 130 (5)  
 • Hermle 130.020 (5)  
 • Hermle 130.070 (5)  
 • Hermle 130.080 (5)  
 • Hermle 130.677 (5)

B005.00190:  
 • Hermle 140.010 (4)  
 • Hermle 140.070 (4)  
 • Hermle 140.080 (4)  
 • Hermle 150.010 (4)



- Hermle 150.070 (4)
- Hermle 150.080 (4)
- Hermle 340.020 (4)
- Hermle 1050.020 (4)

Calibre x (Hermle PDF Part Number)

Code	Description	UOM	Price
HERB00500020	B005.00020 Hermle Third Wheel	EACH	£10.95
HERB00500190	B005.00190 Hermle Third Wheel	EACH	£9.85

## Wheels B006, Escape

Hermle Escape Wheels

Hermle require the calibre as well as the pendulum length that is stamped on the plate (if a pendulum model). If the calibre and pendulum length combination is not below, you can request a quote via our Hermle movement parts search category by searching and selecting "steigrad D" in the Hermle PDF Diagram Number look up and then add it as a non listed item, you will need to provide the pendulum length you require in the description field.



Hermle calibre (Pendulum length stamped on the movement)

Code	Description	UOM	Price
HERB00600020	B006.00020 Hermle 130 Series Escape Wheel	EACH	£8.75
HERB00601060	B006.01060 Hermle 141.041 (23 & 25cm) Escape Wheel	EACH	£10.60
HERB00601410	B006.01410 Hermle 241.840 (85, 94 & 100cm) Escape Wheel	EACH	£5.25
H20166	B006.01600 Hermle 261.030 (45cm) Escape Wheel	EACH	£9.95
H42155	B006.01610 Hermle 261.030 (55cm) Escape Wheel	EACH	£12.45
HERB00601570	B006.01570 Hermle 261.080 (23cm) Escape Wheel	EACH	£4.65
HERB00600200	B006.00200 Hermle 340 Series Escape Wheel	EACH	£9.35
HERB00602060	B006.02060 Hermle 341 Series (25cm) Escape Wheel	EACH	£4.35
H20160	B006.01680 Hermle 341 Series (33.5, 35 & 45mm) Escape Wheel	EACH	£10.95
HERB006013701	B006.013701 Hermle 791.680 (16.5cm) Escape Wheel	EACH	£12.45
H19834	B006.01080 Hermle 1151.050 & 1151.053 (43, 45, 48, 55 & 94cm) Escape Wheel	EACH	£7.15

## Wheels B007, Intermediate

See "More Info" for Calibres & Hermle PDF Part Numbers

Hermle Intermediate Wheel, Going Side (Gehwerk)

- B007.00030
- B007.00050
- B007.00330
- B007.00270



Hermle Intermediate Wheel, Strike Side (Schlagwerk)

- B007.00040

Hermle Intermediate Wheel, Strike Side (Stundenschlag)

- B007.00340

Hermle Intermediate Wheel, Chime Side (Schlagwerk)

- B007.00060
- B007.00280

Hermle Intermediate Wheel, Chime Side (Viertelschlag)

- B007.00122
- B007.00420

Code	Description	UOM	Price
HERB00700030	B007.00030 Hermle Int. Wheel (Going Side)	EACH	£5.10

HERB00700040	B007.00040 Hermle Int. Wheel (Strike Side)	EACH	£10.95
HERB00700050	B007.00050 Hermle Int. Wheel (Going Side)	EACH	£9.85
HERB00700060	B007.00060 Hermle Int. Wheel (Chime Side)	EACH	£9.85
H19948	B007.00122 Hermle Int. Wheel (Chime Side)	EACH	£6.55
HERB00700270	B007.00270 Hermle Int. Wheel (Going Side)	EACH	£8.95
H49168	B007.00280 Hermle Int. Wheel (Chime Side)	EACH	£9.85
HERB00700330	B007.00330 Hermle Int. Wheel (Going Side)	EACH	£12.05
HERB00700340	B007.00340 Hermle Int. Wheel (Strike Side)	EACH	£10.95
HERB00700420	B007.00420 Hermle Int. Wheel (Chime Side)	EACH	£14.25

## Wheels B008, Star

Hermle Star Wheel (Sternrad)

B008.00030:

- Hermle 130 (9)
- Hermle 130.020 (9)
- Hermle 130.070 (9)
- Hermle 130.080 (9)
- Hermle 130.677 (9)



B008.00120:

- Hermle 340.020 (9)
- Hermle 341.020 (6)
- Hermle 350.020 (9)
- Hermle 350.060 (9)
- Hermle 351.020 (6)
- Hermle 351.030 (6)
- Hermle 351.030A (6)
- Hermle 1050.020 (9)
- Hermle 1051.030 (6)
- Hermle 1051.830 (6)

Calibre x (Hermle PDF Part Number)

Code	Description	UOM	Price
HERB00800030	B008.00030 Hermle Star Wheel	EACH	£10.95
HERB00800120	Sternrad (no. 6), Hermle 341.020	EACH	£10.95

## Wheels B009, (Schopferrad)

Hermle Wheel (Schopferrad)

B009.00020:

- Hermle 140.010 (11), 140.070 (11), 140.080 (11)
- Hermle 141.010 (8), 141.034 (6), 141.051 (6), 141.070 (8), 141.080 (8)
- Hermle 150.010 (11), 150.070 (11), 150.080 (11),
- Hermle 151.010 (8), 151.070 (8), 151.080 (8)
- Hermle 241 (6), 241.030 (6), 241.033 (6), 241.080 (6), 241.840 (6)
- Hermle 340.020 (10)
- Hermle 341.020 (7)
- Hermle 350.020 (10), 350.060 (10)
- Hermle 351.020 (7), 351.030 (7), 351.030A (7), 351.051 (7), 351.850 (7)
- Hermle 451.030 (7), 451.050 (7)
- Hermle 461.050 (7), 461.853S (8)
- Hermle 1050.020 (10)
- Hermle 1051.030 (7), 1051.830 (7), 1051.850 (9)
- Hermle 1151.030A (7), 1151.050 (7),
- Hermle 1161.050 (7), 1161.853 (8)



B009.00030:

- Hermle 130 (10)
- Hermle 130.020 (10)
- Hermle 130.070 (10)
- Hermle 130.080 (10)
- Hermle 130.677 (100)
- Hermle 132.071 (10)

Calibre x (Hermle PDF Part Number)

Code	Description	UOM	Price
HERB00900020	B009.00020 Hermle Wheel (Schopferrad)	EACH	£12.95

HERB00900030	B009.00030 Hermle Wheel (Schopferrad)	EACH	£8.95
--------------	---------------------------------------	------	-------

## Wheels B010, Fly (Flugelrad)



Hour Strike Fly Wheels (Stunden-Flugelfad)

B010.00090:

- Hermle 341.020

Chime Strike Fly Wheels (Viertel-Flugelrad)

B010.00070:

- Hermle 341.020

Movements with a Single Fly Wheel (Flugelrad)

B010.00020:

- Hermle 241.840

Movements with a Single Fly Wheel (Flugelrad)

B010.00030:

- Hermle 130
- Hermle 130.020
- Hermle 130.070
- Hermle 130.080
- Hermle 130.677

Calibre x (Hermle PDF Part Number)

Code	Description	UOM	Price
HERB01000020	B010.00020 Hermle Fly Wheel	EACH	£3.95
HERB01000030	B010.00030 Hermle Fly Wheel	EACH	£3.95
HERB01000070	B010.00070 Hermle Fly Wheel (Quarter Chime)	EACH	£3.95
HERB01000090	Stunden-Flugelfad (no. 9), Hermle 341.020	EACH	£3.95

## Wheels B012, Transmission / Exchange

See "More Info" for Calibres & Hermle PDF Part Numbers



Hermle Transmission / Exchange Wheels (Wechselrad)

- B012.00140
- B012.00170
- B012.00182

Code	Description	UOM	Price
HERB01200140	B012.00140 Hermle Transmission Wheel	EACH	£4.95
HERB01200170	B012.00170 Hermle Transmission Wheel	EACH	£3.50
HERB01200182	B012.00182 Hermle Transmission Wheel	EACH	£5.40
HERB01300730	B013.00730 Hermle Transmission Wheel	EACH	£8.75

## Wheels B013, Chain (Strike Side)



Hermle Strike Side Chain Wheels

- Calibre 241 series = (1)
- Calibre 261 series = (2)

- Calibre 451 series = (1)
- Calibre 461 series = (2)
- Calibre 471 series = (3)
- Calibre 1151 series = (1)
- Calibre 1161 series = (3)
- Calibre 1171 series = (4)

Code	Description	UOM	Price
<b>H12149</b>	B013.00260 Hermle Chain Wheel Complete (1)	EACH	<b>£22.55</b>
<b>H20163</b>	B013.00480 Hermle Chain Wheel Complete (2)	EACH	<b>£22.55</b>
<b>H43123</b>	B013.01430 Hermle Chain Wheel Complete (4)	EACH	<b>£22.55</b>
<b>H43125</b>	B013.02270 Hermle Chain Wheel Complete (6)	EACH	<b>£19.95</b>

**Wheels B013, Chain (Time Side & Chime)**

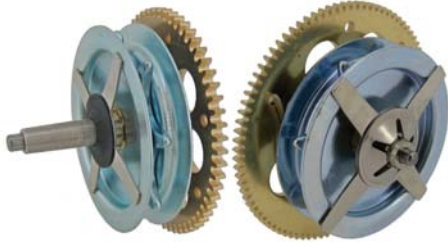

Hermle Time Side & Chime Chain Wheels

- Calibre 241 series = (1) (Time side only)
- Calibre 261 series = (2) (Time side only)
- Calibre 451 series = (1) (Time side & Chime)
- Calibre 461 series = (6) (Time side & Chime)
- Calibre 471 series = (4) (Time side only)
- Calibre 471 series = (5) (Chime only)
- Calibre 1151 series = (1) (Time side & Chime)
- Calibre 1161 series = (3) (Time side & Chime)
- Calibre 1171 series = (4) (Time side only)
- Calibre 1171 series = (5) (Chime only)

Code	Description	UOM	Price
<b>H12150</b>	B013.00250 Hermle Chain Wheel Complete (1)	EACH	<b>£19.95</b>
<b>H20162</b>	B013.00470 Hermle Chain Wheel Complete (2)	EACH	<b>£22.50</b>
<b>H43127</b>	B013.00820 Hermle Chain Wheel Complete (3)	EACH	<b>£19.95</b>
<b>H43126</b>	B013.01420 Hermle Chain Wheel Complete (4)	EACH	<b>£19.95</b>
<b>H45598</b>	B013.01440 Hermle Chain Wheel Complete (5)	EACH	<b>£19.95</b>
<b>H43125</b>	B013.02270 Hermle Chain Wheel Complete (6)	EACH	<b>£19.95</b>

**Wheels B013, Train**

See "More Info" for Calibres & Hermle PDF Part Numbers

Hermle Train Wheel (Fallenrad)  
• B013.00070



Hermle Train Wheel (Schlubrad)  
• B013.02530  
• B013.02570 (B013.00270)  
• B013.02580

Code	Description	UOM	Price
<b>HERB01300070</b>	B013.00070 Hermle Train Wheel (Fallenrad)	EACH	<b>£10.95</b>
<b>HERB01302530</b>	B013.02530 Hermle Train Wheel (Schlubrad)	EACH	<b>£10.95</b>
<b>HERB01302570</b>	B013.02570 (B013.00270) Hermle Train Wheel (Schlubrad)	EACH	<b>£8.50</b>
<b>H19838</b>	B013.02580 Hermle Train Wheel (Schlubrad)	EACH	<b>£6.95</b>

**Online Discounts**

**Wheels B013, Transmission / Exchange**

See "More Info" for Calibres & Hermle PDF Part Numbers



Hermle Transmission / Exchange Wheels (Ubertragungsräd)  
• B013.00730

Code	Description	UOM	Price
<b>HERB01300730</b>	B013.00730 Hermle Transmission Wheel	EACH	<b>£8.75</b>

**Wheels B014, Hour**



Hour Wheels

Hermle require the calibre as well as the hour wheel height. If the calibre and hour wheel height combination is not below, you can request a quote via our Hermle movement parts search category by searching and selecting "hour wheel" in the Hermle PDF Diagram Number look up and then add it as a non listed item, you will need to provide the hour wheel height you require in the description field.

Hermle calibre x (Hour wheel height)

Code	Description	UOM	Price
<b>H20036</b>	B014.01010 Hermle 130 Series (16.30mm) Hour Wheel	EACH	<b>£6.95</b>
<b>H20037</b>	B014.01010 Hermle 130 Series (21.25mm) Hour Wheel	EACH	<b>£6.95</b>
<b>H20173</b>	B014.01010 Hermle 130 Series (44.00mm) Hour Wheel	EACH	<b>£6.95</b>
<b>HERB01401040</b>	B014.01040 Hermle 132.071 (16.75mm) Hour Wheel	EACH	<b>£6.95</b>
<b>H20169</b>	B014.00240 Hermle 241 Series (23.60mm) Hour Wheel	EACH	<b>£6.95</b>
<b>H20168</b>	B014.00720 Hermle 241 Series (43.50mm) Hour Wheel	EACH	<b>£6.95</b>
<b>H20164</b>	B014.01070 Hermle 261 Series (23.60mm) Hour Wheel	EACH	<b>£6.95</b>
<b>H20158</b>	B014.00300 Hermle 341 Series (23.65mm) Hour Wheel	EACH	<b>£6.95</b>
<b>H38472</b>	B014.00300 Hermle 451 Series, 1151 Series (33.10mm) Hour Wheel	EACH	<b>£6.95</b>
<b>H38471</b>	B014.00730 Hermle 451 Series, 1151 Series (53.10mm) Hour Wheel	EACH	<b>£6.95</b>

**Wheels E001, Ratchet**

Hermle Ratchet Wheels (Sperrad)



- E001.03140:  
• Hermle 340.020  
• Hermle 351.020  
• Hermle 791.081  
• Hermle 791.680

- E001.03800:  
• Hermle 130  
• Hermle 130.020  
• Hermle 130.070  
• Hermle 130.080  
• Hermle 130.677  
• Hermle 132.071

Code	Description	UOM	Price
<b>HERE00103140</b>	E001.03140 Hermle Ratchet Wheel	EACH	<b>£2.75</b>
<b>HERE00103800</b>	E001.03800 Hermle Ratchet Wheel	EACH	<b>£2.75</b>

**MOVEMENTS (MECHANICAL) HERMLE**



Hermle recommend that replacing a Hermle clock movement is often quicker and more cost effective than servicing or repairing an old one. Using a new movement ensures you take full advantage of the advances in manufacturing technology. They state that their movements are ready to fit, however some lubrication may be required. Hermle guarantee new movements against mechanical malfunction for a period of two years

**Movement Required:**

If you require a complete movement which is not listed below you can request a quote via our Hermle movement parts search category by searching and selecting "movement" in the Hermle PDF Diagram Number look up and then add it as a non listed item, you will need to provide the pendulum length you require in the description field.

**Pendulum Length:**

The Hermle pendulum length is stamped on the back of the movement, next to or underneath the calibre. The "cm" length is measured from the suspension pinning point to bottom of the pendulum tip.

Hermle state that movements with pendulum lengths 75cm or greater are no longer supplied with a low anchor bridge due to the weight of the pendulum

**Deadbeat v Automatic Beat:**

Automatic beat escapement movements are for narrow waste (pinch waste) grandfather/grandmother clock cases. With automatic beat the case has to be wide enough for the customer to over swing the pendulum when starting the clock. If the clock has a narrow waste it can happen that the dead beat is the only option because the dead beat does not require room for over swing.

Hermle state that movements with pendulum lengths 75cm or greater are no longer supplied with a dead beat due to the size of the pendulum.

- Hermle Clock Movement Service Manual: Item Number H31543
- Please see our PDF document download section for Hermle pendulum length formulas & winding hole configurations
- Pendulum length identification is stamped on the movement (pendulums supplied separately)
- Hermle mechanical hands will fit all Hermle mechanical movements
- All Hermle movements with a low bridge are supplied with pendulum leader L9603 (apart from calibres 471 & 1171).
- All Hermle movements with a high bridge (plus calibres 471 & 1171 which have a low bridge) are supplied with pendulum leader L9604

**PRICE PROMISE GUARANTEE**

**Hermle 130.020**

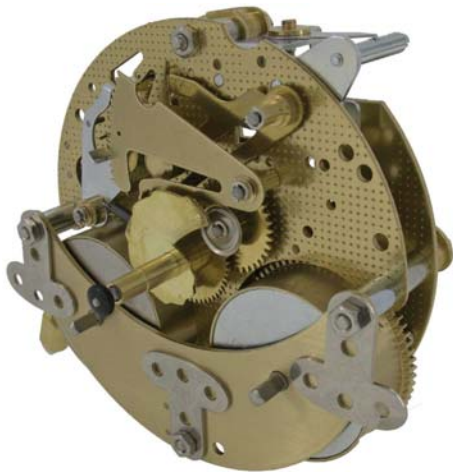

- Hermle 130.020  
8 day bim bam gong, key wound clock movement
- 8 day
  - Strike: Bim Bam gong
  - Hammers: 3 below
  - Plate size: Ø90mm
  - Floating balance
  - Length A: 30.5mm (Plate to hand nut thread, see web diagram)
  - Length B: 25.5mm (Shaft length, see web diagram)
  - Mounting depth: 67mm (tip of handshaft to back of movement)
  - WH2: Winding hole configuration (see web diagram)

Code	Description	UOM	Price
H41601	Hermle 130.020	EACH	£110.00

**Hermle 130.070 (1 Bell)**



- Hermle 130.070  
8 day bim bam, bell behind, key wound clock movement
- 8 day
  - Strike: Bim bam
  - Hammers: 1 behind
  - Plate size: Ø90mm
  - Floating balance
  - Length A: 30.5mm (Plate to hand nut thread, see web diagram)
  - Length B: 25.5mm (Shaft length, see web diagram)
  - Mounting depth: 75mm (tip of handshaft to back of movement)
  - WH2: Winding hole configuration (see web diagram)
  - 1 Bells, Ø51mm

Code	Description	UOM	Price
H42032	Hermle 130.070 (1 Bell)	EACH	£99.95

**Hermle 130.070 (2 Bells)**



- Hermle 130.070  
8 day bim bam, bells behind, key wound clock movement
- 8 day
  - Strike: Bim bam
  - Hammers: 2 behind
  - Plate size: Ø90mm
  - Floating balance
  - Length A: 30.5mm (Plate to hand nut thread, see web diagram)
  - Length B: 25.5mm (Shaft length, see web diagram)
  - Mounting depth: 110mm (tip of handshaft to back of movement)
  - WH2: Winding hole configuration (see web diagram)
  - 2 Bells, Ø60 & 65mm

Code	Description	UOM	Price
H8210	Hermle 130.070	EACH	£79.95

**Hermle 130.080**



- Hermle 130.080  
8 day ships bell, bells on top, key wound clock movement
- 8 day
  - Strike: Ships Bell
  - Hammers: 2 on top
  - Plate size: Ø90mm
  - Floating balance
  - Length A: 30.5mm (Plate to hand nut thread, see web diagram)
  - Length B: 25.5mm (Shaft length, see web diagram)
  - Mounting depth: 62mm (tip of handshaft to back of movement)

- WH2: Winding hole configuration (see web diagram)

Code	Description	UOM	Price
H41602	Hermle 130.080	EACH	£115.00

**Hermle 130.627**



- Hermle 130.627  
8 day bim bam gong, key wound clock movement, back wind
- 8 day
  - Strike: Bim Bam gong
  - Hammers: 3 below
  - Plate size: Ø90mm
  - Floating balance
  - Length A: 30.5mm (Plate to hand nut thread, see web diagram)
  - Length B: 25.5mm (Shaft length, see web diagram)
  - Mounting depth: 90mm (tip of handshaft to back of movement)
  - WH2: Winding hole configuration (see web diagram)
  - Back wind

Code	Description	UOM	Price
H41603	Hermle 130.627	EACH	£145.00

**Deadbeat v Automatic Beat**

*Automatic beat escapement movements are for narrow waste (pinch waste) grandfather/grandmother clock cases. With automatic beat the case has to be wide enough for the customer to over swing the pendulum when starting the clock. If the clock has a narrow waste it can happen that the dead beat is the only option because the dead beat does not require room for over swing.*

**Suspension Springs**

See Page 1290



**Square Dials, Hermle**

See Page 1246



**Hermle 130.677 (1 Bell)**

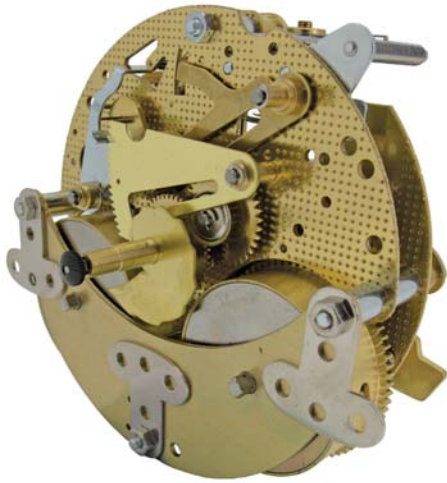

Hermle 130.677

8 day bim bam bell, key wound clock movement, back wind

- 8 day
- Strike: Bim Bam bell
- Hammers: 1 behind
- Plate size: Ø90mm
- Floating balance
- Length A: 30.5mm (Plate to hand nut thread, see web diagram)
- Length B: 25.5mm (Shaft length, see web diagram)
- Mounting depth: 90mm (tip of handshaft to back of movement)
- WH2: Winding hole configuration (see web diagram)
- Back wind

Code	Description	UOM	Price
<b>H8792</b>	Hermle 130.677 (1 Bell)	EACH	<b>£110.00</b>

**Hermle 130.677 (2 Bells)**

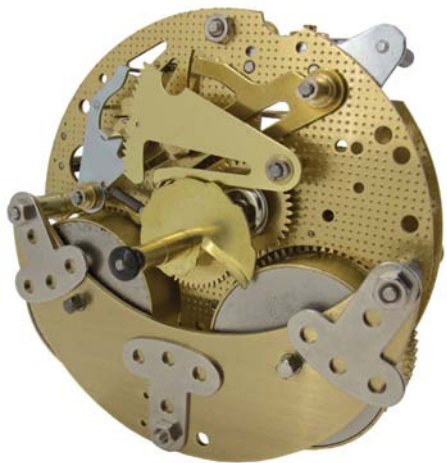

Hermle 130.677

8 day bim bam bell, key wound clock movement, back wind

- 8 day
- Strike: Bim Bam bell
- Hammers: 2 behind
- Plate size: Ø90mm
- Floating balance
- Length A: 30.5mm (Plate to hand nut thread, see web diagram)
- Length B: 25.5mm (Shaft length, see web diagram)
- Mounting depth: 90mm (tip of handshaft to back of movement)
- WH2: Winding hole configuration (see web diagram)
- Back wind

Code	Description	UOM	Price
<b>H48235</b>	Hermle 130.677 (2 Bells)	EACH	<b>£120.00</b>

**Hermle 131.030**

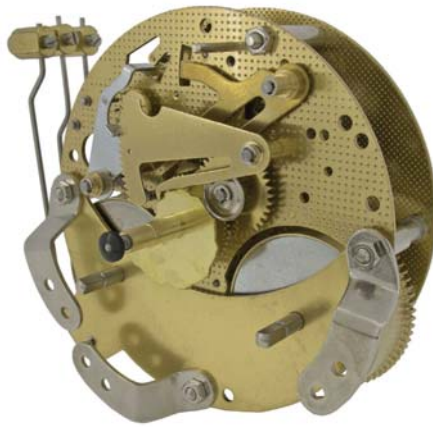

Hermle 131.030

8 day bim bam gong, key wound clock movement

- 8 day
- Strike: Bim Bam gong
- Hammers: 3 at the side
- Plate size: Ø90mm
- Anchor escapement, automatic beat
- Length A: 30.5mm (Plate to hand nut thread, see web diagram)
- Length B: 25.5mm (Shaft length, see web diagram)
- Mounting depth: 83mm (tip of handshaft to back of movement)
- WH2: Winding hole configuration (see web diagram)
- Supplied with pendulum leader (our code L9603)

Available Separately:

- Gong: G46253

Code	Description	UOM	Price
<b>H41604</b>	Hermle 131.030 (21cm)	EACH	<b>£110.00</b>
<b>H41605</b>	Hermle 131.030 (32.5cm)	EACH	<b>£110.00</b>
<b>H41606</b>	Hermle 131.030 (35cm)	EACH	<b>£110.00</b>
<b>H41607</b>	Hermle 131.030 (39cm)	EACH	<b>£110.00</b>
<b>H41608</b>	Hermle 131.030 (45cm)	EACH	<b>£110.00</b>
<b>H41609</b>	Hermle 131.030 (55cm)	EACH	<b>£110.00</b>

**Hermle 131.041**



Hermle 131.041

8 day bim bam gong, key wound clock movement

- 8 day
- Strike: Bim Bam bell
- Hammers: 1 behind
- Plate size: Ø90mm
- Anchor escapement, automatic beat
- Length A: 25.7mm (Plate to hand nut thread, see web diagram)
- Length B: 20.7mm (Shaft length, see web diagram)
- Mounting depth: 85mm (tip of handshaft to back of movement)
- WH2: Winding hole configuration (see web diagram)
- Supplied with pendulum leader (our code L9603)

Code	Description	UOM	Price
<b>H45572</b>	Hermle 131.041 (25cm)	EACH	<b>£150.00</b>

**Hermle 131.070**



Hermle 131.070

8 day bim bam bell, key wound clock movement

- 8 day
- Strike: Bim Bam bell
- Hammers: 2 behind
- Plate size: Ø90mm
- Anchor escapement, automatic beat
- Length A: 30.5mm (Plate to hand nut thread, see web diagram)
- Length B: 25.5mm (Shaft length, see web diagram)
- Mounting depth: 85mm (tip of handshaft to back of movement)
- WH2: Winding hole configuration (see web diagram)
- Supplied with pendulum leader (our code L9603)

Code	Description	UOM	Price
<b>H46463</b>	Hermle 131.070 (31cm)	EACH	<b>£99.95</b>

**Hermle 131.071**

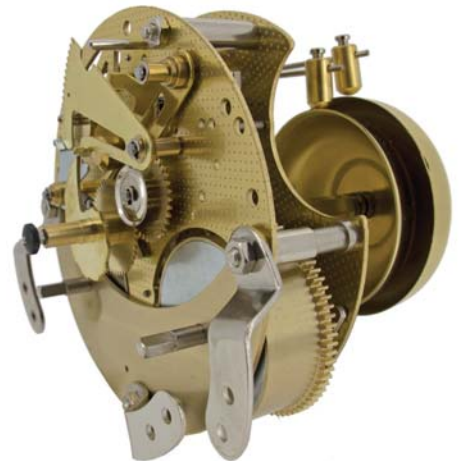

Hermle 131.071

8 day bim bam bell, key wound clock movement

- 8 day
- Strike: Bim Bam bell
- Hammers: 2 behind
- Plate size: Ø90mm
- Anchor escapement, automatic beat
- Includes Pendulum Leader
- Length A: 25.7mm (Plate to hand nut thread, see web diagram)
- Length B: 20.7mm (Shaft length, see web diagram)
- Mounting depth: 85mm (tip of handshaft to back of movement)
- WH2: Winding hole configuration (see web diagram)
- Supplied with pendulum leader (our code L9603)

Code	Description	UOM	Price
<b>H29230</b>	Hermle 131.071 (23cm)	EACH	<b>£125.00</b>
<b>H47431</b>	Hermle 131.071 (25cm)	EACH	<b>£125.00</b>

**Hermle 131.080**

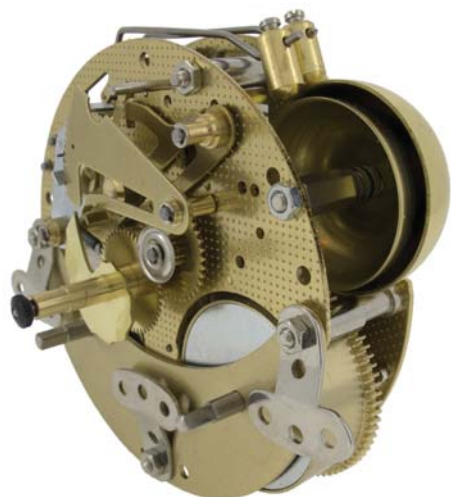

Hermle 131.080

8 day bim bam bell, bells behind, key wound clock movement

- 8 day
- Strike: Bim Bam bell
- Hammers: 2 at the side
- Plate size: Ø90mm
- Anchor escapement, automatic beat
- Length A: 30.5mm (Plate to hand nut thread, see web diagram)
- Length B: 25.5mm (Shaft length, see web diagram)
- Mounting depth: 105mm (tip of handshaft to back of movement)
- WH2: Winding hole configuration (see web diagram)
- Supplied with pendulum leader (our code L9603)

Code	Description	UOM	Price
H42028	Hermle 131.080 (21cm)	EACH	£119.95
H41610	Hermle 131.080 (23cm)	EACH	£119.95
H41611	Hermle 131.080 (35cm)	EACH	£119.95
H41612	Hermle 131.080 (55cm)	EACH	£119.95

**Hermle 132.071SG**

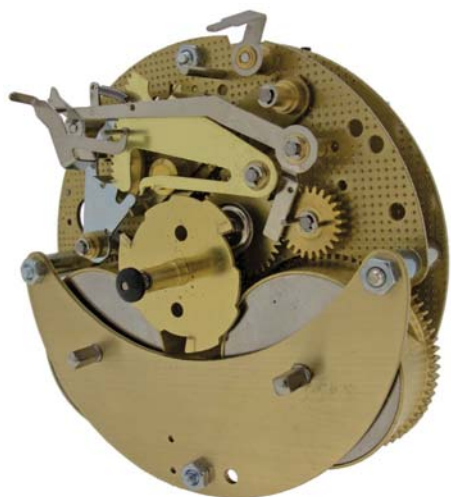

Hermle 132.071SG

8 day ships bell (bell Ø65mm), key wound clock movement with Swiss platform escapement

- 8 day
- Strike: Ships Bell
- Hammers: 1 behind
- Plate size: Ø90mm
- Swiss platform escapement
- Length A: 25.7mm (Plate to hand nut thread, see web diagram)
- Length B: 20.7mm (Shaft length, see web diagram)
- Mounting depth: 70mm (tip of handshaft to back of movement)
- WH2: Winding hole configuration (see web diagram)

- Swiss platform escapement

Hermle state that in this combination, "SG" means the movement has a Swiss platform escapement

Code	Description	UOM	Price
H9310	Hermle 132.071SG (Ships Bell)	EACH	£264.95

**Hermle 141.010**

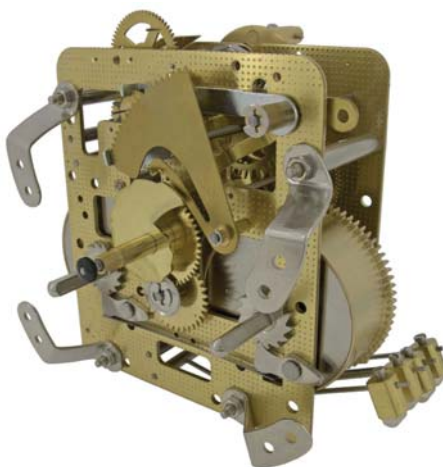

Hermle 141.010

14 day bim bam gong, key wound clock movement

- 14 day
- Strike: Bim Bam
- Hammers: 3 or 4 below
- Plate size: 85 x 98mm
- Anchor escapement, automatic beat
- Length A: 33.2mm (Plate to hand nut thread, see web diagram)
- Length B: 28.5mm (Shaft length, see web diagram)
- Mounting depth: 100mm (tip of handshaft to back of movement)
- WH3: Winding hole configuration (see web diagram)
- Pendulum length identification is stamped on the movement (pendulums supplied separately)
- Pendulum length in brackets
- Supplied with pendulum leader (our code L9603)

Available Separately:

- 3 Rod Gong: G34447
- 4 Rod Gong: G34448

Code	Description	UOM	Price
H48844	Hermle 141.010 (11cm) 3 Hammers	EACH	£115.00

**Hermle 141.020**

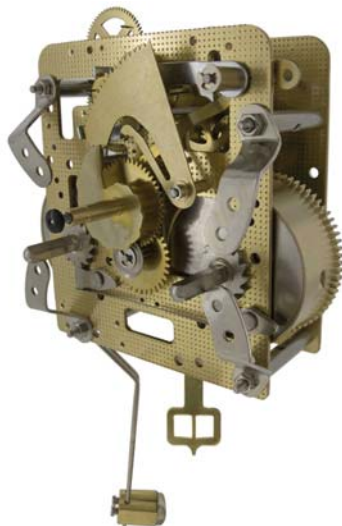

Hermle 141.020

14 day bim bam gong, key wound clock movement

- 14 day

- Strike: Bim Bam
- Hammers: 2 below
- Plate size: 85 x 98mm
- Anchor escapement, automatic beat
- Length A: 33.2mm (Plate to hand nut thread, see web diagram)
- Length B: 28.5mm (Shaft length, see web diagram)
- Mounting depth: 80mm (tip of handshaft to back of movement)
- WH3: Winding hole configuration (see web diagram)
- Pendulum length identification is stamped on the movement (pendulums supplied separately)
- Pendulum length in brackets
- Supplied with pendulum leader (our code L9603)

Available Separately:

- Gong: G46236

Code	Description	UOM	Price
H41616	Hermle 141.020 (52cm)	EACH	£115.00
H41623	Hermle 141.020 (75cm)	EACH	£115.00

**Hermle 141.020 (Dead Beat)**

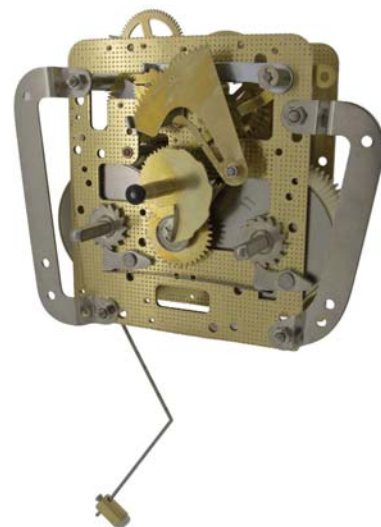

Hermle 141.020

14 day bim bam gong, key wound clock movement, dead beat

- 14 day
- Strike: Bim Bam
- Hammers: 1 below
- Plate size: 85 x 98mm
- Anchor escapement, dead beat
- Length A: 33.2mm (Plate to hand nut thread, see web diagram)
- Length B: 28.5mm (Shaft length, see web diagram)
- Mounting depth: 180mm (tip of handshaft to back of movement)
- WH3: Winding hole configuration (see web diagram)
- Pendulum length identification is stamped on the movement (pendulums supplied separately)
- Pendulum length in brackets
- Supplied with pendulum leader (our code L9603)

Code	Description	UOM	Price
H41615	Hermle 141.020 (21cm)	EACH	£115.00
H41617	Hermle 141.020 (21cm) Front Pendulum	EACH	£115.00
H41618	Hermle 141.020 (32cm) Front Pendulum	EACH	£115.00
H41619	Hermle 141.020 (38cm) Front Pendulum	EACH	£115.00
H41620	Hermle 141.020 (45cm) Front Pendulum	EACH	£115.00
H41622	Hermle 141.020 (52cm) Back Pendulum	EACH	£115.00
H41621	Hermle 141.020 (52cm) Front Pendulum	EACH	£115.00

**PRICE PROMISE GUARANTEE**

**Hermle 141.023 (Dead Beat)**

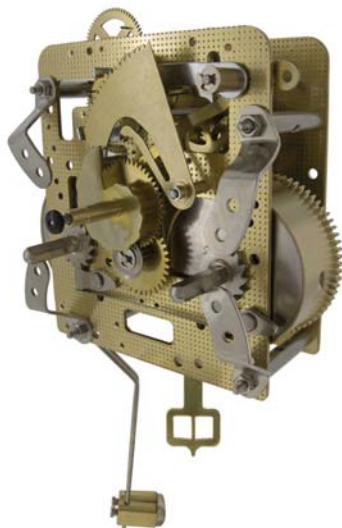

Hermle 141.023

14 day bim bam gong, key wound clock movement, 48.5mm shaft

- 14 day
- Strike: Bim Bam
- Hammers: 2 below
- Plate size: 85 x 98mm
- Anchor escapement, dead beat
- Length A: 53.2mm (Plate to hand nut thread, see web diagram)
- Length B: 48.5mm (Shaft length, see web diagram)
- Mounting depth: 95mm (tip of handshaft to back of movement)
- WH3: Winding hole configuration (see web diagram)
- Pendulum length identification is stamped on the movement (pendulums supplied separately)
- Pendulum length in brackets
- Supplied with pendulum leader (our code L9603)

Code	Description	UOM	Price
H41624	Hermle 141.023 (45cm)	EACH	£110.00

**Hermle 141.030K1 (Calender)**

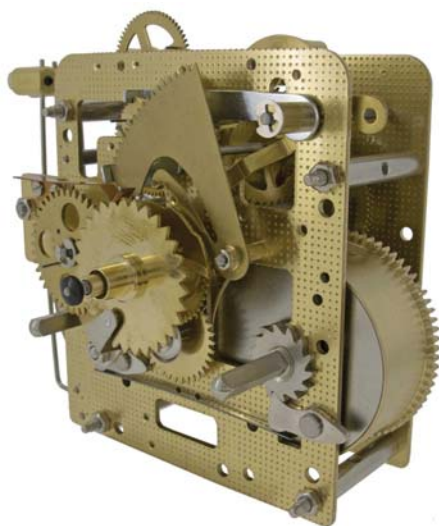

Hermle 141.030K1

14 day bim bam gong, key wound clock movement with date feature

- 14 day
- Strike: Bim Bam
- Hammers: 3 at the side
- Plate size: 85 x 98mm
- Anchor escapement, automatic beat
- Length A: 33.2mm (Plate to hand nut thread, see web diagram)
- Length B: 28.5mm (Shaft length, see web diagram)

- Mounting depth: 100mm (tip of handshaft to back of movement)
- WH3: Winding hole configuration (see web diagram)
- Pendulum length identification is stamped on the movement (pendulums supplied separately)
- Pendulum length in brackets
- K1 Date mechanism, date appears around the outer edge of the dial face
- Supplied with pendulum leader (our code L9603)

Hermle state that in this combination, "K1" means date feature

Available Separately:

- Gong: G46237

Code	Description	UOM	Price
H41625	Hermle 141.030K1 (31cm)	EACH	£149.95
H41626	Hermle 141.030K1 (34cm)	EACH	£149.95
H41627	Hermle 141.030K1 (38cm)	EACH	£149.95
H41628	Hermle 141.030K1 (45cm)	EACH	£149.95
H41629	Hermle 141.030K1 (48cm)	EACH	£149.95
H41630	Hermle 141.030K1 (55cm)	EACH	£149.95
H41631	Hermle 141.030K1 (66cm)	EACH	£149.95

**Hermle 141.031**

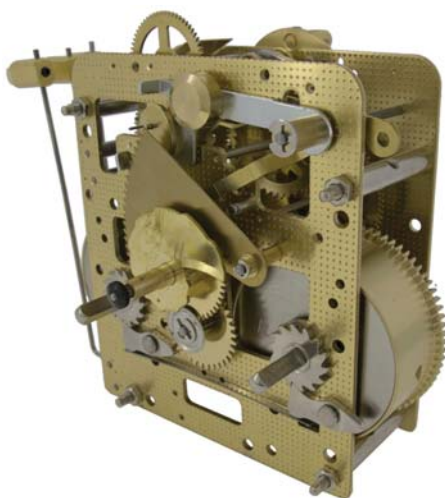

Hermle 141.031

14 day bim bam gong, key wound clock movement, 22.9mm shaft

- 14 day
- Strike: Bim Bam
- Hammers: 3 at the side
- Plate size: 85 x 98mm
- Anchor escapement, automatic beat
- Length A: 27.6mm (Plate to hand nut thread, see web diagram)
- Length B: 22.9mm (Shaft length, see web diagram)
- Mounting depth: 95mm (tip of handshaft to back of movement)
- WH3: Winding hole configuration (see web diagram)
- Pendulum length identification is stamped on the movement (pendulums supplied separately)
- Pendulum length in brackets
- Supplied with pendulum leader (our code L9603)

Code	Description	UOM	Price
H41648	Hermle 141.031 (32cm)	EACH	£159.95
H41649	Hermle 141.031 (45cm)	EACH	£159.95



Square Dials, Hermle

See Page 1246



**Hermle 141.033 (Back Pendulum)**

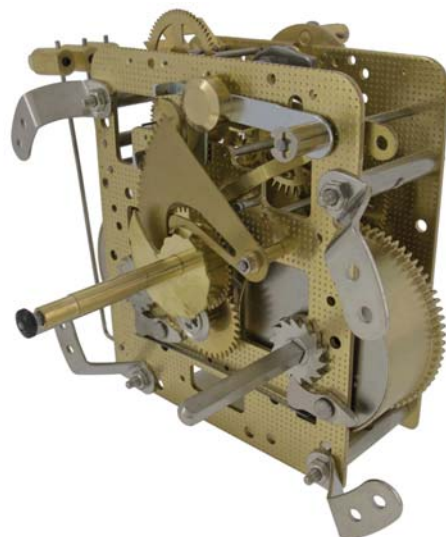

Hermle 141.033

14 day bim bam gong, key wound clock movement, 48.5mm shaft, pendulum at the back

- 14 day
- Strike: Bim Bam
- Hammers: 3 at the side
- Plate size: 85 x 98mm
- Anchor escapement, automatic beat
- Length A: 53.2mm (Plate to hand nut thread, see web diagram)
- Length B: 48.5mm (Shaft length, see web diagram)
- Mounting depth: 108mm (tip of handshaft to back of movement)
- WH3: Winding hole configuration (see web diagram)
- Pendulum length identification is stamped on the movement (pendulums supplied separately)
- Pendulum length in brackets
- Supplied with pendulum leader (our code L9603)

Code	Description	UOM	Price
H41650	Hermle 141.033 (38cm) Back Pendulum	EACH	£125.95

**Hermle 141.033 (Front Pendulum)**

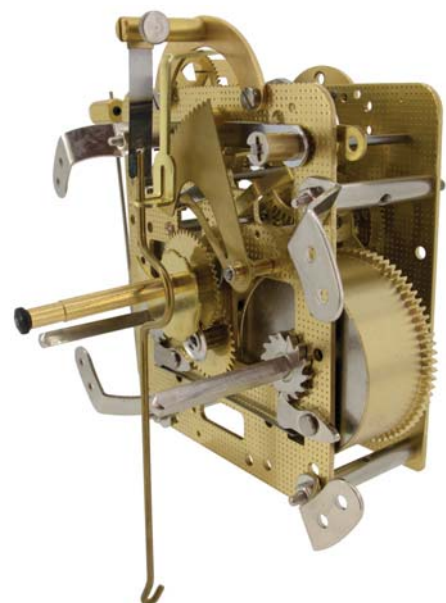

Hermle 141.033

14 day bim bam gong, key wound clock movement, 48.5mm shaft, pendulum at the front

- 14 day
- Strike: Bim Bam
- Hammers: 3 at the side
- Plate size: 85 x 98mm
- Anchor escapement, automatic beat

- Length A: 53.2mm (Plate to hand nut thread, see web diagram)
- Length B: 48.5mm (Shaft length, see web diagram)
- Mounting depth: 108mm (tip of handshaft to back of movement)
- WH3: Winding hole configuration (see web diagram)
- Pendulum length identification is stamped on the movement (pendulums supplied separately)
- Front or back pendulum
- Pendulum length in brackets
- Supplied with pendulum leader (our code L9603)

Code	Description	UOM	Price
H41651	Hermle 141.033 (38cm) Front Pendulum	EACH	£125.95

### Hermle 141.033K3 (Calender)

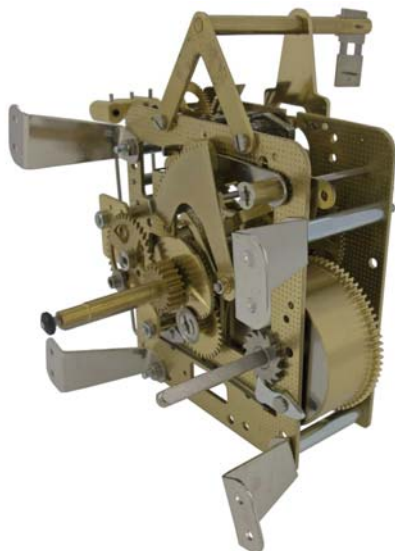

Hermle 141.033K3

14 day bim bam gong, key wound clock movement, 48.5mm shaft with calender feature

- 14 day
- Strike: Bim Bam
- Hammers: 3 at the side
- Plate size: 85 x 98mm
- Anchor escapement, automatic beat
- Length A: 53.2mm (Plate to hand nut thread, see web diagram)
- Length B: 48.5mm (Shaft length, see web diagram)
- Mounting depth: 108mm (tip of handshaft to back of movement)
- WH3: Winding hole configuration (see web diagram)
- Pendulum length identification is stamped on the movement (pendulums supplied separately)
- Pendulum length in brackets
- K3 Calender mechanism, sub dials of date, weekday and month appear below the hour and minute chapter ring on the dial
- Supplied with pendulum leader (our code L9603)

Hermle state that in this combination, "K3" means calender feature

Code	Description	UOM	Price
H41652	Hermle 141.033K3 (66cm)	EACH	£135.00



**ORDER tracking**

Suspension Springs

See Page 1290

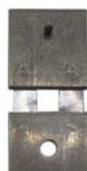

### Hermle 141.040

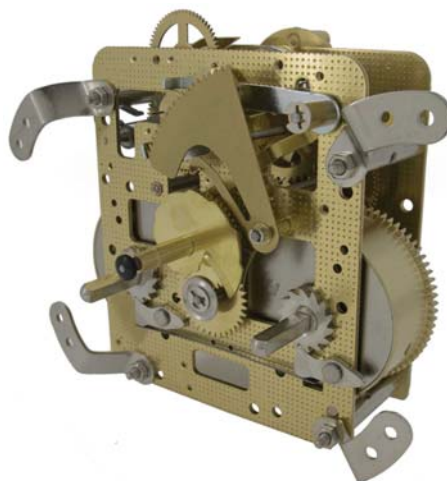

Hermle 141.040

14 day bim bam coil gong, key wound clock movement

- 14 day
- Strike: Bim Bam
- Hammers: 1 behind
- Plate size: 85 x 98mm
- Anchor escapement, automatic beat
- Length A: 33.2mm (Plate to hand nut thread, see web diagram)
- Length B: 28.5mm (Shaft length, see web diagram)
- Mounting depth: 105mm (tip of handshaft to back of movement)
- WH3: Winding hole configuration (see web diagram)
- Pendulum length identification is stamped on the movement (pendulums supplied separately)
- Pendulum length in brackets
- Supplied with pendulum leader (our code L9603)

Available Separately:

- Gong: G46238

Code	Description	UOM	Price
H41653	Hermle 141.040 (29cm)	EACH	£115.00
H41654	Hermle 141.040 (34cm)	EACH	£115.00

### Hermle 141.040K1 (Date)



Hermle 141.040K1

14 day bim bam coil gong, key wound clock movement with date feature

- 14 day
- Strike: Bim Bam
- Hammers: 1 behind
- Plate size: 85 x 98mm
- Anchor escapement, automatic beat
- Length A: 33.2mm (Plate to hand nut thread, see web diagram)
- Length B: 28.5mm (Shaft length, see web diagram)

- Mounting depth: 105mm (tip of handshaft to back of movement)
- WH3: Winding hole configuration (see web diagram)
- Pendulum length identification is stamped on the movement (pendulums supplied separately)
- Pendulum length in brackets
- K1 Date mechanism, date appears around the outer edge of the dial face
- Supplied with pendulum leader (our code L9603)

Hermle state that in this combination, "K1" means date feature

Available Separately:

- Gong: G46238

Code	Description	UOM	Price
H41655	Hermle 141.040K1 (38cm)	EACH	£129.95
H41656	Hermle 141.040K1 (43cm)	EACH	£129.95
H41657	Hermle 141.040K1 (45cm)	EACH	£129.95
H41658	Hermle 141.040K1 (55cm)	EACH	£129.95

### Hermle 141.041

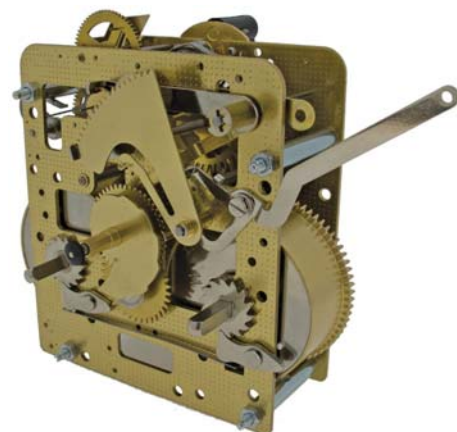

Hermle 141.041

14 day bim bam coil gong, key wound clock movement, 22.9mm shaft

- 14 day
- Strike: Bim Bam
- Hammers: 1 behind
- Plate size: 85 x 98mm
- Anchor escapement, automatic beat
- Length A: 27.6mm (Plate to hand nut thread, see web diagram)
- Length B: 22.9mm (Shaft length, see web diagram)
- Mounting depth: 98mm (tip of handshaft to back of movement)
- WH3: Winding hole configuration (see web diagram)
- Pendulum length identification is stamped on the movement (pendulums supplied separately)
- Pendulum length in brackets
- Supplied with pendulum leader (our code L9603)

Available Separately:

- Gong: G46238

Code	Description	UOM	Price
H40138	Hermle 141.041 (11cm)	EACH	£115.00
H40139	Hermle 141.041 (12cm)	EACH	£115.00
H40140	Hermle 141.041 (15cm)	EACH	£115.00
H40141	Hermle 141.041 (21cm)	EACH	£115.00
H40142	Hermle 141.041 (23cm)	EACH	£115.00
H40143	Hermle 141.041 (25cm)	EACH	£115.00
H40144	Hermle 141.041 (26.5cm)	EACH	£115.00
H40145	Hermle 141.041 (27cm)	EACH	£115.00
H40146	Hermle 141.041 (29cm)	EACH	£115.00
H8789	Hermle 141.041 (31cm)	EACH	£115.00
H40147	Hermle 141.041 (32cm)	EACH	£115.00
H8790	Hermle 141.041 (34cm)	EACH	£115.00
H40148	Hermle 141.041 (38cm)	EACH	£115.00
H8791	Hermle 141.041 (43cm)	EACH	£115.00
H40149	Hermle 141.041 (45cm)	EACH	£115.00
H40150	Hermle 141.041 (48cm)	EACH	£115.00
H40151	Hermle 141.041 (52cm)	EACH	£115.00
H40152	Hermle 141.041 (55cm)	EACH	£115.00

<b>H40153</b>	Hermle 141.041 (66cm)	EACH	<b>£115.00</b>
<b>H40154</b>	Hermle 141.041 (75cm)	EACH	<b>£115.00</b>
<b>H40155</b>	Hermle 141.041 (85cm)	EACH	<b>£115.00</b>
<b>H40156</b>	Hermle 141.041 (94cm)	EACH	<b>£115.00</b>
<b>H40157</b>	Hermle 141.041 (114cm)	EACH	<b>£115.00</b>

## Hermle 141.043

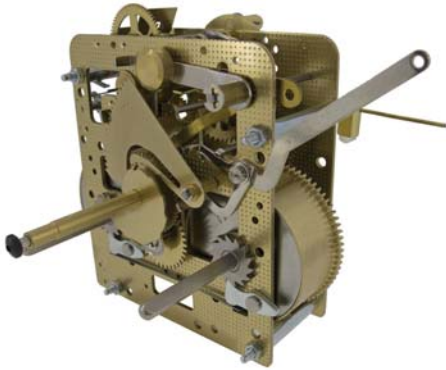

Hermle 141.043

14 day bim bam coil gong, key wound clock movement, 48.5mm shaft

- 14 day
- Strike: Bim Bam
- Hammers: 1 behind
- Plate size: 85 x 98mm
- Anchor escapement, automatic beat
- Length A: 53.2mm (Plate to hand nut thread, see web diagram)
- Length B: 48.5mm (Shaft length, see web diagram)
- Mounting depth: 125mm (tip of handshaft to back of movement)
- WH3: Winding hole configuration (see web diagram)
- Pendulum length identification is stamped on the movement (pendulums supplied separately)
- Pendulum length in brackets
- Supplied with pendulum leader (our code L9603)

Code	Description	UOM	Price
<b>H41659</b>	Hermle 141.043 (114cm)	EACH	<b>£115.00</b>

## Hermle 141.050

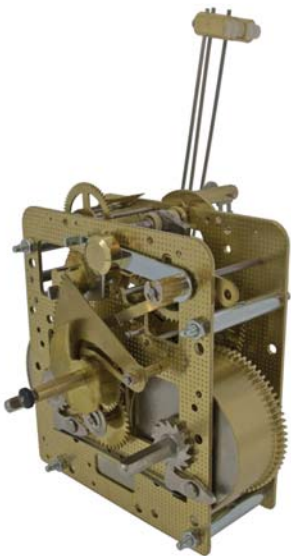

Hermle 141.050

14 day bim bam gong, key wound clock movement

- 14 day
- Strike: Bim Bam
- Hammers: 3 on top
- Plate size: 85 x 98mm
- Anchor escapement, automatic beat
- Length A: 33.2mm (Plate to hand nut thread, see web diagram)
- Length B: 28.5mm (Shaft length, see web diagram)

- Mounting depth: 120mm (tip of handshaft to back of movement)
- WH3: Winding hole configuration (see web diagram)
- Pendulum length identification is stamped on the movement (pendulums supplied separately)
- Pendulum length in brackets
- Supplied with pendulum leader (our code L9603)

Available Separately:

- Gong: G46239

Code	Description	UOM	Price
<b>H41660</b>	Hermle 141.050 (85cm)	EACH	<b>£115.00</b>

## Hermle 141.070

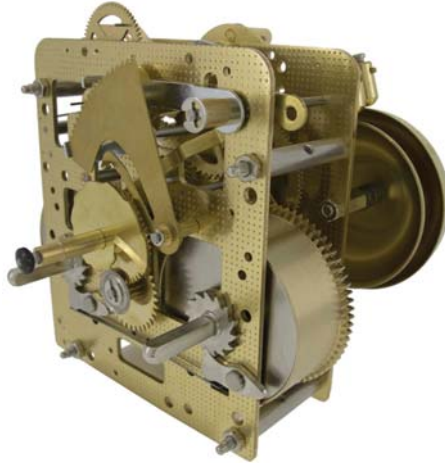

Hermle 141.070

14 day bim bam coil gong, key wound clock movement

- 14 day
- Strike: Bim Bam
- Hammers: 2 behind
- Plate size: 85 x 98mm
- Anchor escapement, automatic beat
- Length A: 33.2mm (Plate to hand nut thread, see web diagram)
- Length B: 28.5mm (Shaft length, see web diagram)
- Mounting depth: 103mm (tip of handshaft to back of movement)
- WH3: Winding hole configuration (see web diagram)
- Pendulum length identification is stamped on the movement (pendulums supplied separately)
- Pendulum length in brackets
- Supplied with pendulum leader (our code L9603)

Code	Description	UOM	Price
<b>H41661</b>	Hermle 141.070 (21cm)	EACH	<b>£125.00</b>
<b>H41662</b>	Hermle 141.070 (23cm)	EACH	<b>£125.00</b>

### Deadbeat v Automatic Beat

*Automatic beat escapement movements are for narrow waste (pinch waste) grandfather/grandmother clock cases. With automatic beat the case has to be wide enough for the customer to over swing the pendulum when starting the clock. If the clock has a narrow waste it can happen that the dead beat is the only option because the dead beat does not require room for over swing.*

## Hermle 141.080

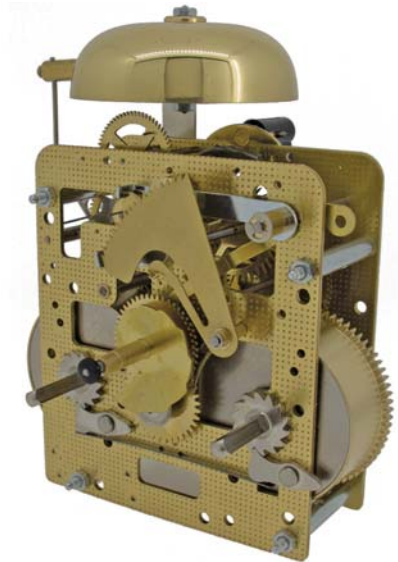

Hermle 141.080

14 day bim bam bell, key wound clock movement

- 14 day
- Strike: Bim Bam
- Hammers: 1 at the side
- Plate size: 85 x 98mm
- Anchor escapement, automatic beat
- Length A: 33.2mm (Plate to hand nut thread, see web diagram)
- Length B: 28.5mm (Shaft length, see web diagram)
- Mounting depth: 92mm (tip of handshaft to back of movement)
- WH3: Winding hole configuration (see web diagram)
- Pendulum length identification is stamped on the movement (pendulums supplied separately)
- Pendulum length in brackets
- Supplied with pendulum leader (our code L9603)

Code	Description	UOM	Price
<b>H40161</b>	Hermle 141.080 (21cm)	EACH	<b>£125.00</b>
<b>H40169</b>	Hermle 141.080 (34cm)	EACH	<b>£125.00</b>
<b>H40170</b>	Hermle 141.080 (38cm)	EACH	<b>£125.00</b>
<b>H141080</b>	Hermle 141.080 (43cm)	EACH	<b>£125.00</b>
<b>H40171</b>	Hermle 141.080 (45cm)	EACH	<b>£125.00</b>
<b>H40177</b>	Hermle 141.080 (85cm)	EACH	<b>£125.00</b>

## Hermle 150.010

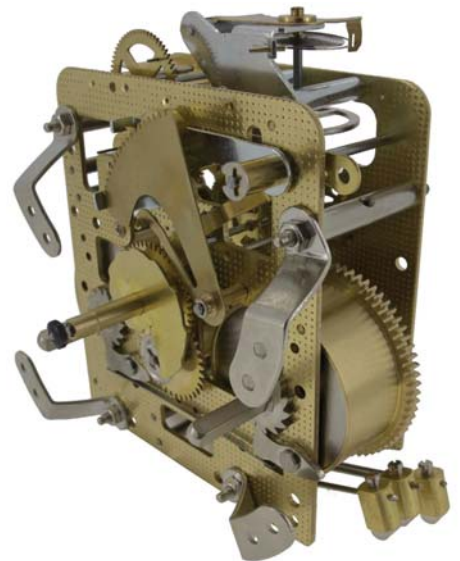

Hermle 150.010

8 day bim bam gong, key wound clock movement

- 8 day
- Strike: Bim Bam
- Hammers: 3 below



- Plate size: 85 x 98mm
- Floating balance
- Length A: 33.2mm (Plate to hand nut thread, see web diagram)
- Length B: 28.5mm (Shaft length, see web diagram)
- Mounting depth: 87mm (tip of handshaft to back of movement)
- WH3: Winding hole configuration (see web diagram)

Code	Description	UOM	Price
H41663	Hermle 150.010	EACH	£140.00

**Hermle 150.070**

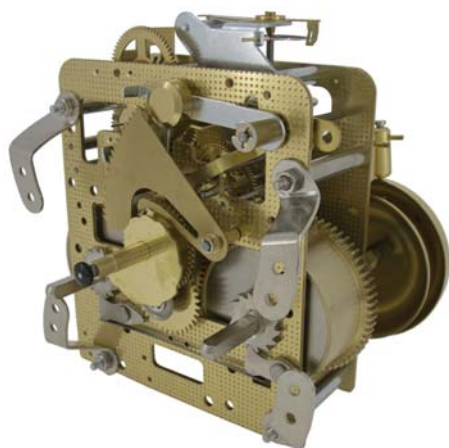

Hermle 150.070  
8 day bim bam bell, key wound clock movement

- 8 day
- Strike: Bim Bam
- Hammers: 2 behind
- Plate size: 85 x 98mm
- Floating balance
- Length A: 33.2mm (Plate to hand nut thread, see web diagram)
- Length B: 28.5mm (Shaft length, see web diagram)
- Mounting depth: 105mm (tip of handshaft to back of movement)
- WH3: Winding hole configuration (see web diagram)

Code	Description	UOM	Price
H41664	Hermle 150.070	EACH	£140.00

**Hermle 150.080**

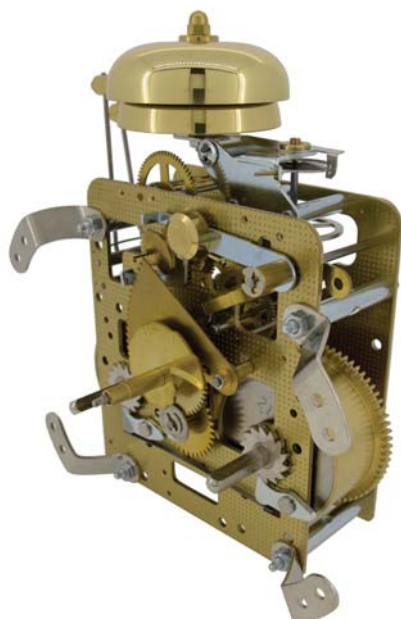

Hermle 150.080  
8 day bim bam bell, key wound clock movement

- 8 day
- Strike: Bim Bam

- Hammers: 2 at the side
- Plate size: 85 x 98mm
- Floating balance
- Length A: 33.2mm (Plate to hand nut thread, see web diagram)
- Length B: 28.5mm (Shaft length, see web diagram)
- Mounting depth: 78mm (tip of handshaft to back of movement)
- WH3: Winding hole configuration (see web diagram)

Code	Description	UOM	Price
H41665	Hermle 150.080	EACH	£160.00

**Hermle 241.030**

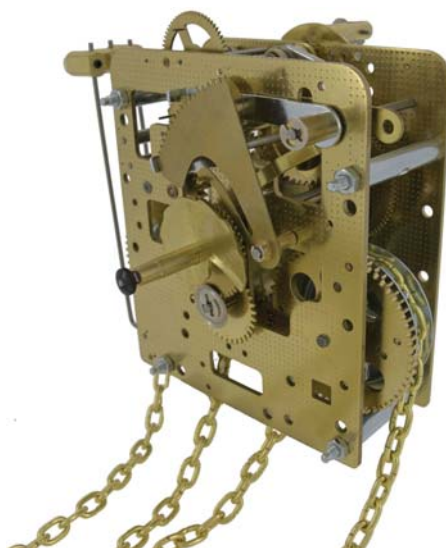

Hermle 241.030  
8 day bim bam gong, weight driven clock movement

- 8 day
- Strike: Bim Bam
- Hammers: 3 at the side
- Plate size: 85 x 98mm
- Anchor escapement, automatic beat
- Length A: 33.2mm (Plate to hand nut thread, see web diagram)
- Length B: 28.5mm (Shaft length, see web diagram)
- Mounting depth: 96mm (tip of handshaft to back of movement)
- Weight driven
- Pendulum length identification is stamped on the movement (pendulums supplied separately)
- Pendulum length in brackets
- Supplied with pendulum leader (our code L9603)

- Available separately:
- 2Kg weight: HERE00502700
  - Weight shell: H46148
  - Gong: G46240

Code	Description	UOM	Price
H41666	Hermle 241.030 (31cm)	EACH	£115.00
H41667	Hermle 241.030 (45cm)	EACH	£115.00
H41668	Hermle 241.030 (55cm)	EACH	£115.00
H41669	Hermle 241.030 (66cm)	EACH	£115.00
H41670	Hermle 241.030 (75cm)	EACH	£115.00
H41671	Hermle 241.030 (85cm)	EACH	£115.00

**Pendulum Lengths**

*The Hermle pendulum length is stamped on the back of the movement, next to or underneath the calibre. The "cm" length is measured from the top of the clock movement to the bottom of the pendulum.*

**Hermle 241.033**



8 day bim bam gong, weight driven clock movement, 48.5mm shaft

- 8 day
- Strike: Bim Bam
- Hammers: 3 at the side
- Plate size: 85 x 98mm
- Anchor escapement, automatic beat
- Length A: 53.2mm (Plate to hand nut thread, see web diagram)
- Length B: 48.5mm (Shaft length, see web diagram)
- Mounting depth: 120mm (tip of handshaft to back of movement)
- Weight driven
- Pendulum length identification is stamped on the movement (pendulums supplied separately)
- Pendulum length in brackets
- Supplied with pendulum leader (our code L9603)

- Supplied separately:
- 2Kg weight: HERE00502700
  - Weight shell: H46148
  - Gong: G46240

Code	Description	UOM	Price
H47010	Hermle 241.033 (85cm)	EACH	£115.00

**Hermle 241.033H (High Bridge)**

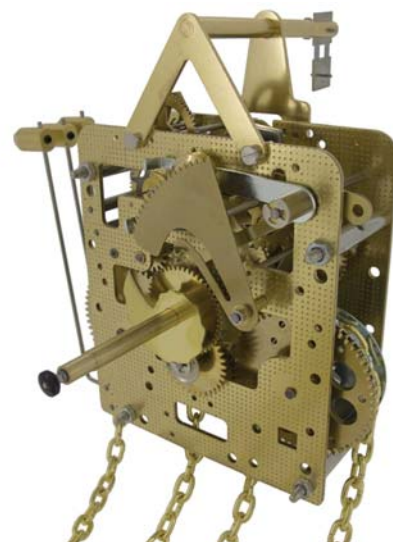

Hermle 241.033H  
8 day bim bam gong, weight driven clock movement, 48.5mm shaft

- 8 day
- Strike: Bim Bam
- Hammers: 3 at the side
- Plate size: 85 x 98mm
- Anchor escapement, automatic beat
- Length A: 53.2mm (Plate to hand nut thread, see web diagram)
- Length B: 48.5mm (Shaft length, see web diagram)
- Mounting depth: 120mm (tip of handshaft to back of movement)
- Weight driven

- Pendulum length identification is stamped on the movement (pendulums supplied separately)
- Pendulum length in brackets
- Supplied with pendulum leader (our code L9604)

Hermle state that in this combination, "H" means high bridge

Available separately:

- 2Kg weight: HERE00502700
- Weight shell: H46148
- Gong: G46240

Code	Description	UOM	Price
H41672	Hermle 241.033H (85cm)	EACH	£115.00

## Hermle 241.050

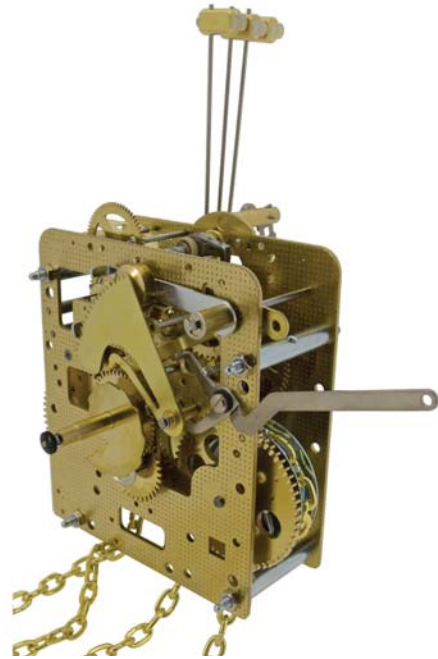

Hermle 241.050

8 day bim bam bell, weight driven clock movement

- 8 day
- Strike: Bim Bam
- Hammers: 3 at the top
- Plate size: 104 x 108mm
- Anchor escapement, automatic beat
- Length A: 33.2mm (Plate to hand nut thread, see web diagram)
- Length B: 28.5mm (Shaft length, see web diagram)
- Mounting depth: 122mm (tip of handshaft to back of movement)
- Weight driven
- Pendulum length identification is stamped on the movement (pendulums supplied separately)
- Pendulum length in brackets
- Supplied with pendulum leader (our code L9603)

Available separately:

- 2Kg weight: HERE00502700
- Weight shell: H46148
- Gong: G46241

Code	Description	UOM	Price
H45567	Hermle 241.050 (85cm)	EACH	£125.00

## Hermle Clock Movement Service Manual



Ref: H31543  
See Page: 1376

## Hermle 241.080

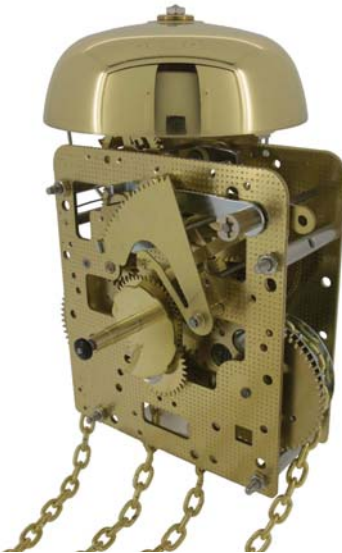

Hermle 241.080

8 day bim bam bell, weight driven clock movement

- 8 day
- Strike: Bim Bam
- Hammers: 1 at the side
- Plate size: 85 x 98mm
- Anchor escapement, automatic beat
- Length A: 33.2mm (Plate to hand nut thread, see web diagram)
- Length B: 28.5mm (Shaft length, see web diagram)
- Mounting depth: 112mm (tip of handshaft to back of movement)
- Weight driven
- Pendulum length identification is stamped on the movement (pendulums supplied separately)
- Pendulum length in brackets
- Supplied with pendulum leader (our code L9603)

Available separately:

- 2Kg weight: HERE00502700
- Weight shell: H46148

Code	Description	UOM	Price
H41673	Hermle 241.080 (32cm)	EACH	£115.00

## Hermle 241.080H



Hermle 241.080

8 day bim bam bell, weight driven clock movement

- 8 day
- Strike: Bim Bam
- Hammers: 1 at the side
- Plate size: 85 x 98mm
- Anchor escapement, automatic beat

- Length A: 33.2mm (Plate to hand nut thread, see web diagram)
- Length B: 28.5mm (Shaft length, see web diagram)
- Mounting depth: 112mm (tip of handshaft to back of movement)
- Weight driven
- Pendulum length identification is stamped on the movement (pendulums supplied separately)
- Pendulum length in brackets
- Supplied with pendulum leader (our code L9604)

Hermle state that in this combination, "H" means high bridge

Available separately:

- 2Kg weight: HERE00502700
- Weight shell: H46148

Code	Description	UOM	Price
H47148	Hermle 241.080H (94cm)	EACH	£125.00

## Hermle 241.840

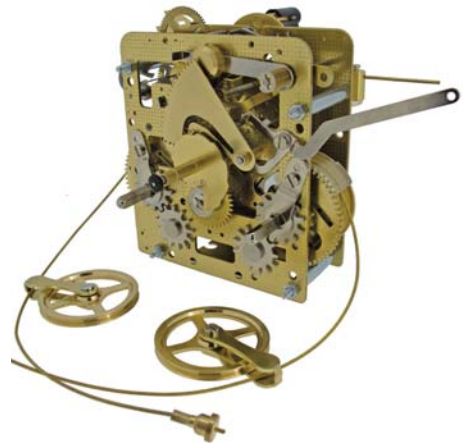

Hermle 241.840

8 day bim bam gong, cable driven clock movement

- 8 day
- Strike: Bim Bam
- Hammers: 1 behind
- Plate size: 85 x 98mm
- Anchor escapement, automatic beat
- Length A: 33.2mm (Plate to hand nut thread, see web diagram)
- Length B: 28.5mm (Shaft length, see web diagram)
- Mounting depth: 104mm (tip of handshaft to back of movement)
- Cable driven
- WH7: Winding hole configuration (see web diagram)
- Pendulum length identification is stamped on the movement (pendulums supplied separately)
- Pendulum length in brackets
- Supplied with pendulum leader (our code L9603)

Available separately:

- 3.6Kg weight: W46180
- Weight shell: H46181
- Gong G46238

Code	Description	UOM	Price
H9580	Hermle 241.840 (75cm)	EACH	£135.00
H40951	Hermle 241.840 (85cm)	EACH	£135.00
H40952	Hermle 241.840 (94cm)	EACH	£135.00
H40953	Hermle 241.840 (100cm)	EACH	£135.00
H40954	Hermle 241.840 (114cm)	EACH	£135.00

*Please see our PDF document download section for Hermle pendulum length formulas and winding hole configurations.*

**Hermle 241.843**

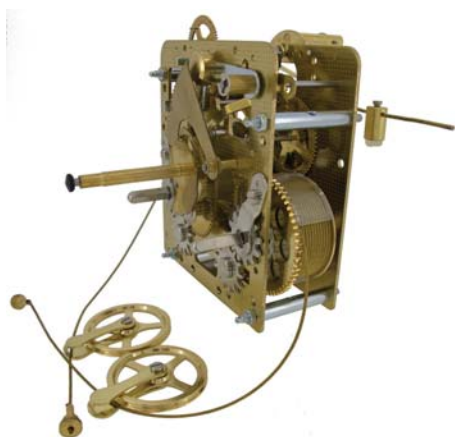

Hermle 241.843

8 day bim bam gong, cable driven clock movement, 48.5mm shaft

- 8 day
- Strike: Bim Bam
- Hammers: 1 behind
- Plate size: 85 x 98mm
- Anchor escapement, automatic beat
- Length A: 53.2mm (Plate to hand nut thread, see web diagram)
- Length B: 48.5mm (Shaft length, see web diagram)
- Mounting depth: 120mm (tip of handshaft to back of movement)
- Cable driven
- WH7: Winding hole configuration (see web diagram)
- Pendulum length identification is stamped on the movement (pendulums supplied separately)
- Pendulum length in brackets
- Supplied with pendulum leader (our code L9603)

Available separately:

- 3.6Kg weight: W46180
- Weight shell: H46181

Code	Description	UOM	Price
H41675	Hermle 241.843 (75cm)	EACH	£140.00

**Hermle 261.030 (A)**

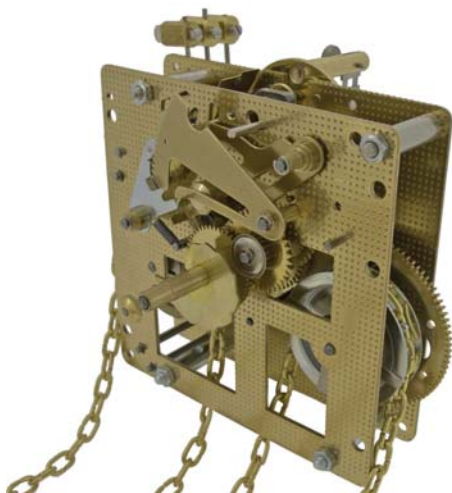

Hermle 261.030 (261.030A)

8 day bim bam gong, weight driven clock movement

- 8 day
- Strike: Bim Bam
- Hammers: 3 at the side
- Plate size: 87 x 87mm
- Anchor escapement, automatic beat
- Length A: 32.1mm (Plate to hand nut thread, see web diagram)
- Length B: 27.4mm (Shaft length, see web diagram)
- Mounting depth: 90mm (tip of handshaft to back of movement)
- Weight driven

- Pendulum length identification is stamped on the movement (pendulums supplied separately)
- Pendulum length in brackets
- Supplied with pendulum leader (our code L9603)

Hermle state that the "A" after a calibre is an engineering code and is irrelevant

Available Separately:

- Gong: G46242

Code	Description	UOM	Price
H41676	Hermle 261.030 (A) (31cm)	EACH	£99.95
H41677	Hermle 261.030 (A) (45cm)	EACH	£99.95
H41678	Hermle 261.030 (A) (55cm)	EACH	£99.95
H41679	Hermle 261.080 (A) (23cm)	EACH	£99.95
H41680	Hermle 261.080 (A) (31cm)	EACH	£99.95
H41681	Hermle 261.080 (A) (45cm)	EACH	£99.95

**Hermle 261.080 (A)**

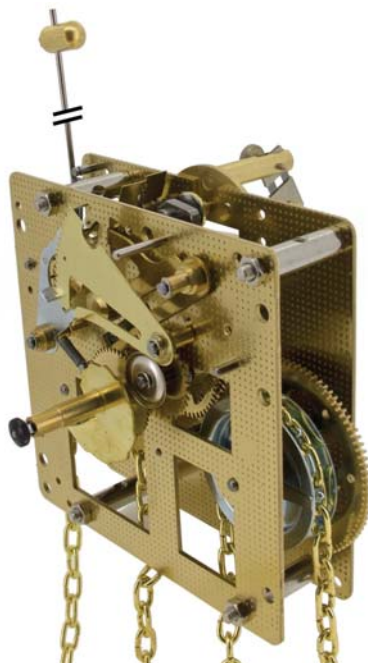

Hermle 261.080 (261.080A)

8 day bim bam bell, weight driven clock movement

- 8 day
- Strike: Bim Bam
- Hammers: 1 on top
- Plate size: 87 x 87mm
- Anchor escapement, automatic beat
- Length A: 32.1mm (Plate to hand nut thread, see web diagram)
- Length B: 27.4mm (Shaft length, see web diagram)
- Mounting depth: 95mm (tip of handshaft to back of movement)
- Weight driven
- Pendulum length identification is stamped on the movement (pendulums supplied separately)
- Pendulum length in brackets
- Supplied with pendulum leader (our code L9603)

Hermle state that the "A" after a calibre is an engineering code and is irrelevant

Code	Description	UOM	Price
H29231	Hermle 261.080 (A) (31cm)	EACH	£115.00

**Pendulum Lengths**

*The Hermle pendulum length is stamped on the back of the movement, next to or underneath the calibre. The "cm" length is measured from the top of the clock movement to the bottom of the pendulum.*

**Hermle 271.081**

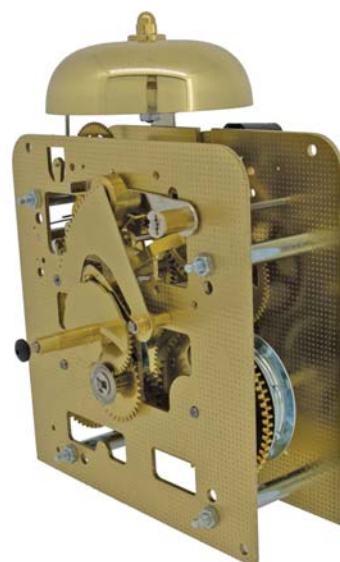

Hermle 271.081

Hermle 271.08X series is now obsolete. Hermle recommend calibre 241.080 as a replacement however please see the information given as the movement specifications (plate sizes) are different and therefore not directly interchangeable.

8 day bim bam bell, weight driven clock movement

- 8 day
- Strike: Bim Bam
- Hammers: 1 at the side
- Plate size: 104 x 108mm
- Anchor escapement, automatic beat
- Length A: 27.6mm (Plate to hand nut thread, see web diagram)
- Length B: 22.9mm (Shaft length, see web diagram)
- Mounting depth: 112mm (tip of handshaft to back of movement)
- Weight driven
- Pendulum length identification is stamped on the movement (pendulums supplied separately)
- Pendulum length in brackets
- Supplied with pendulum leader (our code L9603)

Code	Description	UOM	Price
H9311	Hermle 271.081 (100cm)	EACH	£89.95

**Hermle 340.020 (A)**

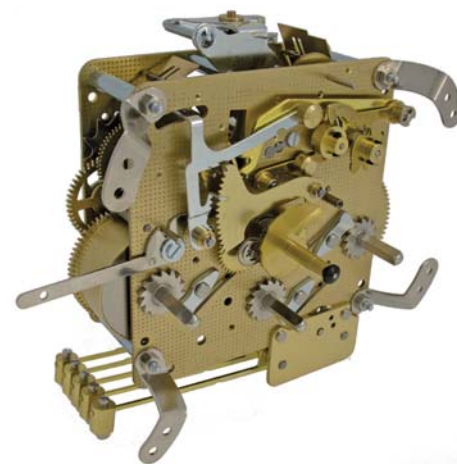

Hermle 340.020 (A)

8 day Westminster chime, key wound clock movement

- 8 day
- Strike: Westminster
- Hammers: 5 below
- Plate size: 100 x 100mm
- Floating balance
- Length A: 33.2mm (Plate to hand nut thread, see web diagram)
- Length B: 28.5mm (Shaft length, see web diagram)

# MOVEMENTS (MECHANICAL) HERMLE

- Mounting depth: 91mm (tip of handshaft to back of movement)
- WH1: Winding hole configuration (see web diagram)
- Night silence mechanism

Hermle state that the "A" after a calibre is an engineering code and is irrelevant

Available Separately:

- Gong: G7755

Code	Description	UOM	Price
H8209	Hermle 340.020 (A)	EACH	£138.95

## Hermle 340.020K3 (Calender)

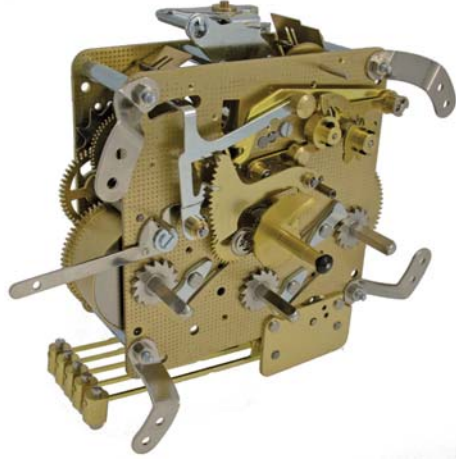

Hermle 340.020K3

8 day Westminster chime, key wound clock movement with calender feature

- 8 day
- Strike: Westminster
- Hammers: 5 below
- Plate size: 100 x 100mm
- Floating balance
- Length A: 33.2mm (Plate to hand nut thread, see web diagram)
- Length B: 28.5mm (Shaft length, see web diagram)
- Mounting depth: 91mm (tip of handshaft to back of movement)
- WH1: Winding hole configuration (see web diagram)
- K3 Calender mechanism, sub dials of date, weekday and month appear below the hour and minute chapter ring on the dial

Hermle state that in this combination, "K3" means calender feature

Code	Description	UOM	Price
H41683	Hermle 340.020K3	EACH	£215.00

## Hermle 341.020 (A)

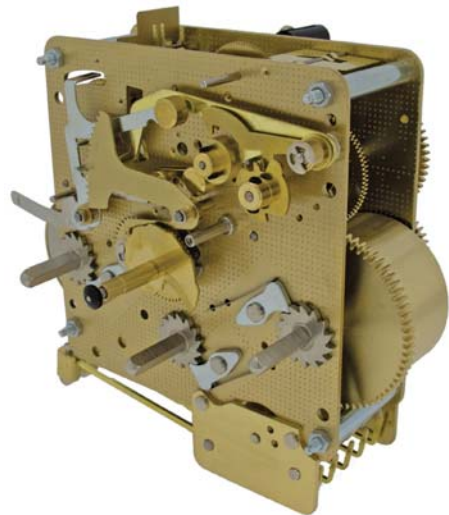

Hermle 341.020 (341.020A)

8 day Westminster chime, key wound clock movement

- 8 day
- Strike: Westminster
- Hammers: 5 below
- Plate size: 100 x 100mm
- Anchor escapement, automatic beat
- Length A: 33.2mm (Plate to hand nut thread, see web diagram)
- Length B: 28.5mm (Shaft length, see web diagram)
- Mounting depth: 109mm (tip of handshaft to back of movement)
- WH1: Winding hole configuration (see web diagram)
- Pendulum length is stamped on the movement (Pendulums supplied separately)
- Pendulum length in brackets
- Supplied with pendulum leader (our code L9603)

Hermle state that the "A" after a calibre is an engineering code and is irrelevant

Available Separately:

- Gong: H28885

Code	Description	UOM	Price
H40906	Hermle 341.020 (A) (11cm)	EACH	£175.00
H41684	Hermle 341.020 (A) (25cm)	EACH	£175.00
H40907	Hermle 341.020 (A) (33.5cm)	EACH	£175.00
H40908	Hermle 341.020 (A) (35cm)	EACH	£175.00
H41685	Hermle 341.020 (A) (38.5cm)	EACH	£175.00
H9582	Hermle 341.020 (A) (45cm)	EACH	£175.00

## Hermle 341.020K3 (Calender)

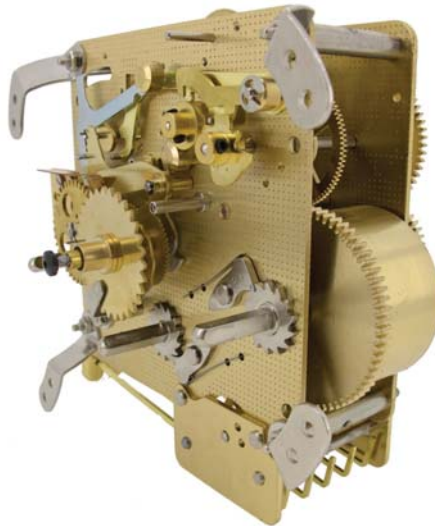

Hermle 341.020K3

8 day Westminster chime, key wound clock movement with calender feature

- 8 day
- Strike: Westminster
- Hammers: 5 below
- Plate size: 100 x 100mm
- Anchor escapement, automatic beat
- Length A: 33.2mm (Plate to hand nut thread, see web diagram)
- Length B: 28.5mm (Shaft length, see web diagram)
- Mounting depth: 109mm (tip of handshaft to back of movement)
- WH1: Winding hole configuration (see web diagram)
- Pendulum length identification is stamped on the movement (pendulums supplied separately)
- Pendulum length in brackets
- K3 Calender mechanism, sub dials of date, weekday and month appear below the hour and minute chapter ring on the dial
- Supplied with pendulum leader (our code L9603)

Hermle state that in this combination, "K3" means calender feature

Available Separately:

- Gong: H28885

Code	Description	UOM	Price
H41686	Hermle 341.020K3 (45cm)	EACH	£165.00

## Hermle 341.021 (A)

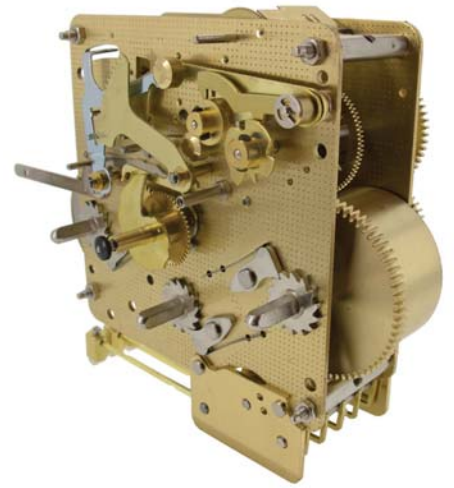

Hermle 341.021 (341.021A)

8 day Westminster chime, key wound clock movement, 22.9mm shaft

- 8 day
- Strike: Westminster
- Hammers: 5 below
- Plate size: 100 x 100mm
- Anchor escapement, automatic beat
- Length A: 27.6mm (Plate to hand nut thread, see web diagram)
- Length B: 22.9mm (Shaft length, see web diagram)
- Mounting depth: 102mm (tip of handshaft to back of movement)
- WH1: Winding hole configuration (see web diagram)
- Pendulum length is stamped on the movement
- Pendulum length in brackets
- Supplied with pendulum leader (our code L9603)

Hermle state that the "A" after a calibre is an engineering code and is irrelevant

Available Separately:

- Gong: H28885

Code	Description	UOM	Price
H41550	Hermle 341.021 (A) (25cm)	EACH	£169.95
H41551	Hermle 341.021 (A) (31cm)	EACH	£169.95
H41552	Hermle 341.021 (A) (35cm)	EACH	£169.95
H41553	Hermle 341.021 (A) (38.5cm)	EACH	£169.95
H41554	Hermle 341.021 (A) (45cm)	EACH	£169.95

## Hermle 350.020

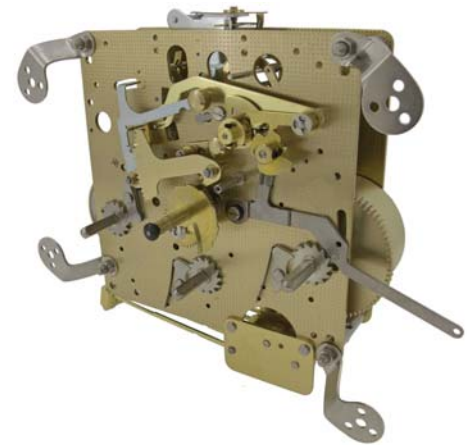

Hermle 350.020

8 day Westminster chime, key wound clock movement

- 8 day
- Strike: Westminster
- Hammers: 5 below
- Plate size: 120 x 120mm
- Floating balance

- Length A: 33.2mm (Plate to hand nut thread, see web diagram)
  - Length B: 28.5mm (Shaft length, see web diagram)
  - Mounting depth: 95mm (tip of handshaft to back of movement)
  - WH5: Winding hole configuration (see web diagram)
  - Supplied with chime and strike shut off (silence) lever
- Available Separately:
- Gong: G46157

Code	Description	UOM	Price
H41687	Hermle 350.020	EACH	£199.95

**Hermle 350.060**

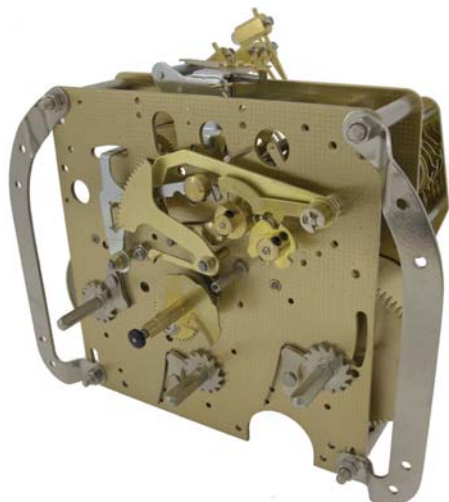

- Hermle 350.060  
8 day Westminster chime, key wound clock movement
- 8 day
  - Strike: Westminster
  - Hammers: 5 behind
  - Plate size: 120 x 120mm
  - Floating balance
  - Length A: 33.2mm (Plate to hand nut thread, see web diagram)
  - Length B: 28.5mm (Shaft length, see web diagram)
  - Mounting depth: 130mm (tip of handshaft to back of movement)
  - WH5: Winding hole configuration (see web diagram)

Code	Description	UOM	Price
H41688	Hermle 350.060	EACH	£225.00

**Hermle 351.020**

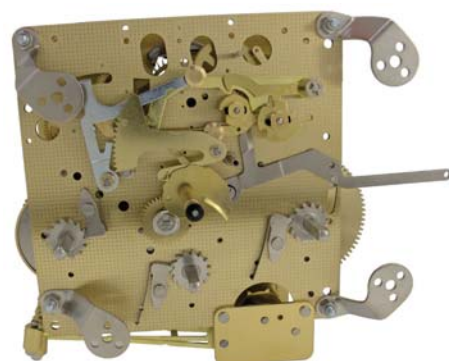

- Hermle 351.020  
8 day Westminster chime, key wound clock movement
- 8 day
  - Strike: Westminster
  - Hammers: 5 below
  - Plate size: 120 x 120mm
  - Anchor escapement, automatic beat
  - Length A: 33.2mm (Plate to hand nut thread, see web diagram)
  - Length B: 28.5mm (Shaft length, see web diagram)

- Mounting depth: 108mm (tip of handshaft to back of movement)
- WH5: Winding hole configuration (see web diagram)
- Pendulum length identification is stamped on the movement (pendulums supplied separately)
- Pendulum length in brackets
- Supplied with chime and strike shut off (silence) lever
- Supplied with pendulum leader (our code L9603)

Available Separately:  
• Gong: G46243

Code	Description	UOM	Price
H40909	Hermle 351.020 (11cm)	EACH	£179.95
H40910	Hermle 351.020 (12cm)	EACH	£179.95
H40911	Hermle 351.020 (15cm)	EACH	£179.95
H40912	Hermle 351.020 (21cm)	EACH	£179.95
H40913	Hermle 351.020 (23cm)	EACH	£179.95
H40914	Hermle 351.020 (25cm)	EACH	£179.95
H40915	Hermle 351.020 (26.5cm)	EACH	£179.95
H40916	Hermle 351.020 (27cm)	EACH	£179.95
H40917	Hermle 351.020 (29cm)	EACH	£179.95
H40918	Hermle 351.020 (31cm)	EACH	£179.95
H40919	Hermle 351.020 (32cm)	EACH	£179.95
H40920	Hermle 351.020 (34cm)	EACH	£179.95
H40921	Hermle 351.020 (38cm)	EACH	£179.95
H41689	Hermle 351.020 (38cm) Non Bushed	EACH	£179.95
H40922	Hermle 351.020 (43cm)	EACH	£179.95
H40923	Hermle 351.020 (45cm)	EACH	£179.95
H40924	Hermle 351.020 (48cm)	EACH	£179.95
H40925	Hermle 351.020 (52cm)	EACH	£179.95
H40926	Hermle 351.020 (55cm)	EACH	£179.95
H40927	Hermle 351.020 (66cm)	EACH	£179.95
H38656	Hermle 351.020 (75cm)	EACH	£179.95
H40928	Hermle 351.020 (85cm)	EACH	£179.95
H40929	Hermle 351.020 (94cm)	EACH	£179.95
H40930	Hermle 351.020 (100cm)	EACH	£179.95
H40931	Hermle 351.020 (114cm)	EACH	£179.95

**Hermle 351.021**

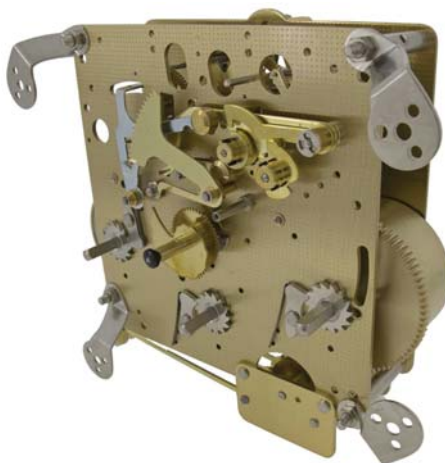

- Hermle 351.021  
8 day Westminster chime, key wound clock movement, 22.9mm shaft
- 8 day
  - Strike: Westminster
  - Hammers: 5 below
  - Plate size: 120 x 120mm
  - Anchor escapement, automatic beat
  - Length A: 27.6mm (Plate to hand nut thread, see web diagram)
  - Length B: 22.9mm (Shaft length, see web diagram)
  - Mounting depth: 100mm (tip of handshaft to back of movement)
  - WH5: Winding hole configuration (see web diagram)
  - Pendulum length identification is stamped on the movement (pendulums supplied separately)
  - Pendulum length in brackets
  - Supplied with pendulum leader (our code L9603)

Available Separately:

- Gong: G46243

Code	Description	UOM	Price
H41690	Hermle 351.021 (26.5cm)	EACH	£189.95
H41691	Hermle 351.021 (31cm)	EACH	£189.95
H41692	Hermle 351.021 (34.5cm)	EACH	£189.95

**Hermle 351.030**

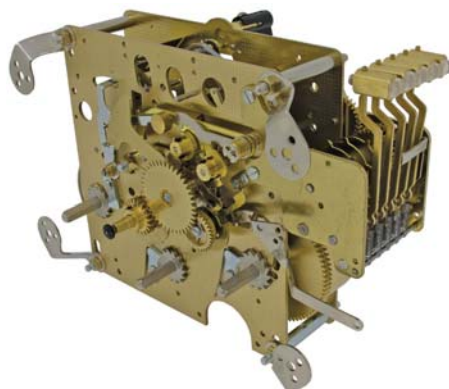

- Hermle 351.030  
8 day Westminster chime, key wound clock movement
- 8 day
  - Strike: Westminster
  - Hammers: 5 at the side
  - Plate size: 120 x 120mm
  - Anchor escapement, automatic beat
  - Length A: 33.2mm (Plate to hand nut thread, see web diagram)
  - Length B: 28.5mm (Shaft length, see web diagram)
  - Mounting depth: 110mm (tip of handshaft to back of movement)
  - WH5: Winding hole configuration (see web diagram)
  - Pendulum length identification is stamped on the movement (pendulums supplied separately)
  - Pendulum length in brackets
  - Supplied with chime and strike shut off (silence) lever
  - Supplied with pendulum leader (our code L9603)

Available Separately:

- Gong: G46244

Code	Description	UOM	Price
H40955	Hermle 351.030 (15cm)	EACH	£185.00
H40956	Hermle 351.030 (21cm)	EACH	£185.00
H40957	Hermle 351.030 (23cm)	EACH	£185.00
H40958	Hermle 351.030 (25cm)	EACH	£185.00
H40959	Hermle 351.030 (26.5cm)	EACH	£185.00
H40960	Hermle 351.030 (27cm)	EACH	£185.00
H40961	Hermle 351.030 (29cm)	EACH	£185.00
H40962	Hermle 351.030 (31cm)	EACH	£185.00
H40963	Hermle 351.030 (32cm)	EACH	£185.00
H40964	Hermle 351.030 (34cm)	EACH	£185.00
H40965	Hermle 351.030 (38cm)	EACH	£185.00
H40966	Hermle 351.030 (43cm)	EACH	£185.00
H40967	Hermle 351.030 (45cm)	EACH	£185.00
H40968	Hermle 351.030 (48cm)	EACH	£185.00
H9624	Hermle 351.030 (52cm)	EACH	£185.00
H40969	Hermle 351.030 (55cm)	EACH	£185.00
H40970	Hermle 351.030 (66cm)	EACH	£185.00
H40971	Hermle 351.030 (75cm)	EACH	£185.00
H40972	Hermle 351.030 (85cm)	EACH	£185.00
H40973	Hermle 351.030 (94cm)	EACH	£185.00
H40974	Hermle 351.030 (100cm)	EACH	£185.00
H40975	Hermle 351.030 (114cm)	EACH	£185.00

*Please see our PDF document download section for Hermle pendulum length formulas and winding hole configurations.*

**Hermle 351.030HS (High Bridge, Seconds)**

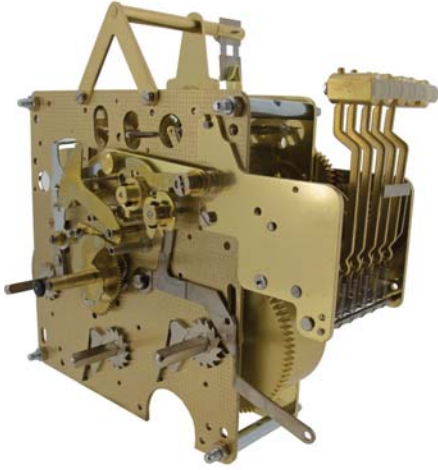

Hermle 351.030S

8 day Westminster chime, key wound clock movement with seconds

- 8 day
- Strike: Westminster
- Hammers: 5 at the side
- Plate size: 120 x 120mm
- Anchor escapement, automatic beat
- Length A: 33.2mm (Plate to hand nut thread, see web diagram)
- Length B: 28.5mm (Shaft length, see web diagram)
- Mounting depth: 110mm (tip of handshaft to back of movement)
- WH5: Winding hole configuration (see web diagram)
- Pendulum length identification is stamped on the movement (pendulums supplied separately)
- Pendulum length in brackets
- Seconds feature
- Supplied with chime and strike shut off (silence) lever
- Supplied with pendulum leader (our code L9603)

Hermle state that in this combination, "H" means high bridge & "S" means seconds feature

Available Separately:

- Gong: G46244

Code	Description	UOM	Price
H41693	Hermle 351.030HS (66cm)	EACH	£189.95

**Hermle 351.031**

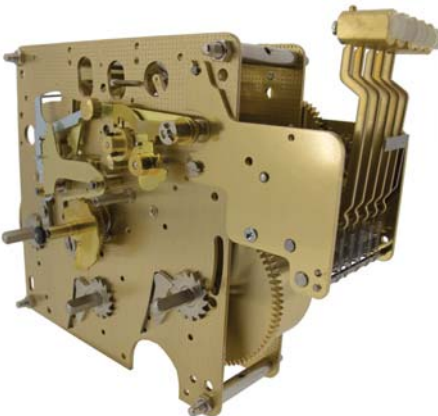

Hermle 351.031

8 day Westminster chime, key wound clock movement, 22.9mm shaft

- 8 day
- Strike: Westminster
- Hammers: 5 at the side
- Plate size: 120 x 120mm
- Anchor escapement, automatic beat
- Length A: 27.6mm (Plate to hand nut thread, see web diagram)
- Length B: 22.9mm (Shaft length, see web diagram)

- Mounting depth: 90mm (tip of handshaft to back of movement)
- WH5: Winding hole configuration (see web diagram)
- Pendulum length identification is stamped on the movement (pendulums supplied separately)
- Pendulum length in brackets
- Supplied with pendulum leader (our code L9603)

Available Separately:

- Gong: G46244

Code	Description	UOM	Price
H41694	Hermle 351.031 (34cm)	EACH	£179.95
H41695	Hermle 351.031 (38cm)	EACH	£179.95
H41696	Hermle 351.031 (45cm)	EACH	£179.95
H41697	Hermle 351.031 (48cm)	EACH	£179.95
H41698	Hermle 351.031 (55cm)	EACH	£179.95
H41699	Hermle 351.031 (75cm)	EACH	£179.95

**Hermle 351.050**

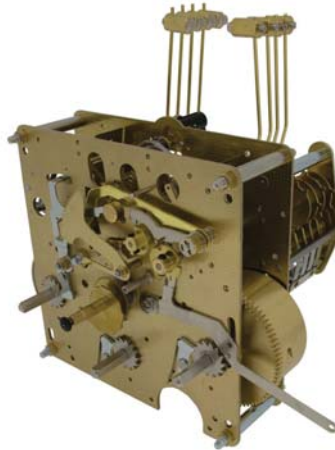

Hermle 351-050

8 day Westminster chime, key wound clock movement

- 8 day
- Strike: Westminster
- Hammers: 8 behind
- Plate size: 120 x 120mm
- Anchor escapement, automatic beat
- Length A: 33.2mm (Plate to hand nut thread, see web diagram)
- Length B: 28.5mm (Shaft length, see web diagram)
- Mounting depth: 145mm (tip of handshaft to back of movement)
- WH5: Winding hole configuration (see web diagram)
- Pendulum length identification is stamped on the movement (pendulums supplied separately)
- Pendulum length in brackets
- Supplied with chime and strike shut off (silence) lever
- Supplied with pendulum leader (our code L9603)

Available Separately:

- Gong: H28887

Code	Description	UOM	Price
H40976	Hermle 351.050 (15cm)	EACH	£169.95
H40977	Hermle 351.050 (21cm)	EACH	£169.95
H40978	Hermle 351.050 (23cm)	EACH	£169.95
H40979	Hermle 351.050 (25cm)	EACH	£169.95
H40980	Hermle 351.050 (26.5cm)	EACH	£169.95
H40981	Hermle 351.050 (27cm)	EACH	£169.95
H40982	Hermle 351.050 (27cm)	EACH	£169.95
H40983	Hermle 351.050 (31cm)	EACH	£169.95
H8993	Hermle 351.050 (32cm)	EACH	£169.95
H8994	Hermle 351.050 (34cm)	EACH	£169.95
H40984	Hermle 351.050 (38cm)	EACH	£169.95
H40985	Hermle 351.050 (43cm)	EACH	£169.95
H40986	Hermle 351.050 (48cm)	EACH	£169.95
H40987	Hermle 351.050 (55cm)	EACH	£169.95
H40988	Hermle 351.050 (66cm)	EACH	£169.95
H40989	Hermle 351.050 (75cm)	EACH	£169.95
H40990	Hermle 351.050 (85cm)	EACH	£169.95
H40991	Hermle 351.050 (94cm)	EACH	£169.95
H40992	Hermle 351.050 (100cm)	EACH	£169.95
H40993	Hermle 351.050 (114cm)	EACH	£169.95

**Hermle 351.051**

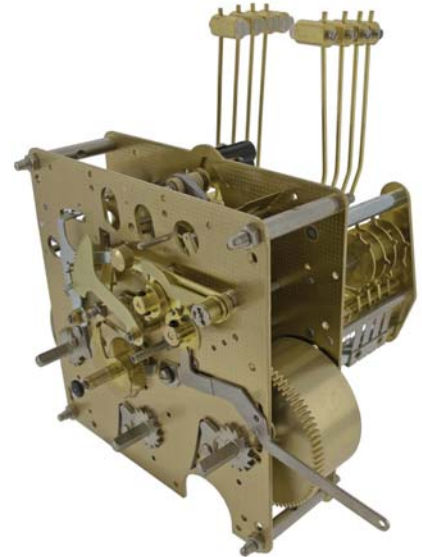

Hermle 351.051

8 day Westminster chime, key wound clock movement, 22.9mm shaft

- 8 day
- Strike: Westminster
- Hammers: 8 behind
- Plate size: 120 x 120mm
- Anchor escapement, automatic beat
- Length A: 27.6mm (Plate to hand nut thread, see web diagram)
- Length B: 22.9mm (Shaft length, see web diagram)
- Mounting depth: 145mm (tip of handshaft to back of movement)
- WH5: Winding hole configuration (see web diagram)
- Pendulum length identification is stamped on the movement (pendulums supplied separately)
- Pendulum length in brackets
- Supplied with chime and strike shut off (silence) lever
- Supplied with pendulum leader (our code L9603)

Available Separately:

- Gong: H28887

Code	Description	UOM	Price
H43201	Hermle 351.051 (38cm)	EACH	£179.95
H41701	Hermle 351.051 (43cm)	EACH	£179.95
H41702	Hermle 351.051 (48cm)	EACH	£179.95

**Hermle 351.060**

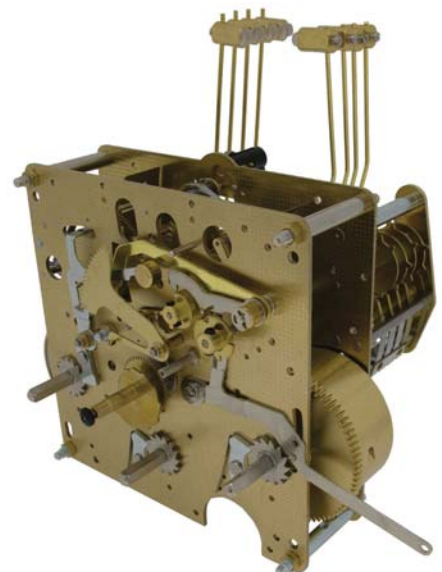

Hermle 351.060

8 day Westminster chime, key wound clock movement

- 8 day

- Strike: Westminster
- Hammers: 8 behind
- Plate size: 120 x 120mm
- Anchor escapement, automatic beat
- Length A: 33.2mm (Plate to hand nut thread, see web diagram)
- Length B: 28.5mm (Shaft length, see web diagram)
- Mounting depth: 145mm (tip of handshaft to back of movement)
- WH5: Winding hole configuration (see web diagram)
- Pendulum length identification is stamped on the movement (pendulums supplied separately)
- Pendulum length in brackets
- Supplied with chime and strike shut off (silence) lever
- Supplied with pendulum leader (our code L9603)

Code	Description	UOM	Price
H41704	Hermle 351.060 (32cm)	EACH	£225.00

**Hermle 351.830**

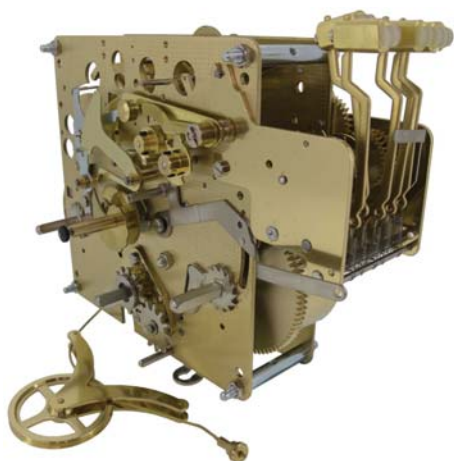

Hermle 351.830

8 day Westminster chime, weight driven clock movement

- 8 day
- Strike: Westminster
- Hammers: 5 at the side
- Plate size: 120 x 120mm
- Anchor escapement, automatic beat
- Length A: 33.2mm (Plate to hand nut thread, see web diagram)
- Length B: 28.5mm (Shaft length, see web diagram)
- Mounting depth: 105mm (tip of handshaft to back of movement)
- WH5: Winding hole configuration (see web diagram)
- Cable driven
- Pendulum length identification is stamped on the movement (pendulums supplied separately)
- Pendulum length in brackets
- Supplied with chime and strike shut off (silence) lever
- Supplied with pendulum leader (our code L9603)

Available separately:

- 2.75Kg weight: H42143
- Weight shell: H42142
- Gong: G46244

Code	Description	UOM	Price
H41705	Hermle 351.830 (66cm)	EACH	£250.00
H41886	Hermle 351.830 (75cm)	EACH	£250.00
H41706	Hermle 351.830 (85cm)	EACH	£250.00

**Pendulumn Lengths**

*The Hermle pendulum length is stamped on the back of the movement, next to or underneath the calibre. The "cm" length is measured from the top of the clock movement to the bottom of the pendulum.*

**Hermle 351.850H (High Bridge)**

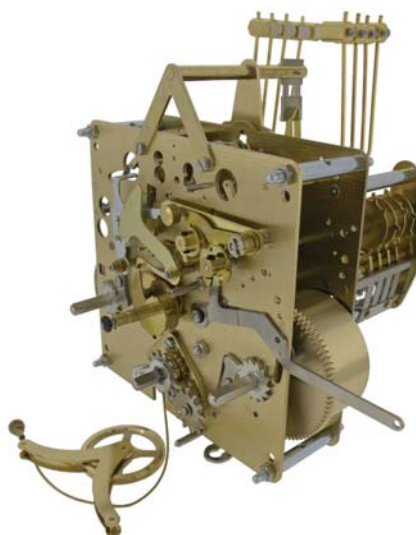

Hermle 351.850H

8 day Westminster chime, cable driven time, weight driven chime clock movement

- 8 day
- Strike: Westminster
- Hammers: 8 behind
- Plate size: 120 x 120mm
- Anchor escapement, automatic beat
- Length A: 33.2mm (Plate to hand nut thread, see web diagram)
- Length B: 28.5mm (Shaft length, see web diagram)
- Mounting depth: 115mm (tip of handshaft to back of movement)
- WH5: Winding hole configuration (see web diagram)
- Cable driven
- Pendulum length identification is stamped on the movement (pendulums supplied separately)
- Pendulum length in brackets
- Supplied with chime and strike shut off (silence) lever
- Supplied with pendulum leader (our code L9604)

Hermle state that in this combination, "H" means high bridge

Available separately:

- 2.75Kg weight: H42143
- Weight shell: H42142
- Gong: H28887

Code	Description	UOM	Price
H41555	Hermle 351.850H (66cm)	EACH	£220.00
H42035	Hermle 351.850H (75cm)	EACH	£220.00
H41556	Hermle 351.850H (85cm)	EACH	£220.00
H41557	Hermle 351.850H (114cm)	EACH	£220.00

**Hermle 451.030H (High Bridge)**

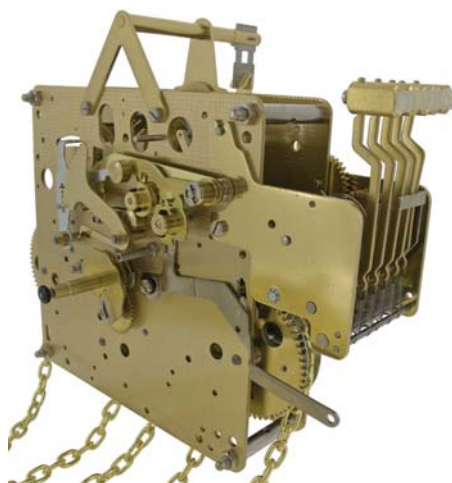

Hermle 451.030H

8 day triple chime, weight driven clock movement

- 8 day
- Strike: Triple chime
- Hammers: 5 at the side
- Plate size: 120 x 120mm
- Anchor escapement, automatic beat
- Length A: 33.2mm (Plate to hand nut thread, see web diagram)
- Length B: 28.5mm (Shaft length, see web diagram)
- Mounting depth: 110mm (tip of handshaft to back of movement)
- Weight driven
- Pendulum length identification is stamped on the movement (pendulums supplied separately)
- Pendulum length in brackets
- Supplied with chime and strike shut off (silence) lever
- Supplied with pendulum leader (our code L9604)

Hermle state that in this combination, "H" means high bridge

Available separately:

- 2Kg weight: HERE00502700
- 2.89Kg weight: HERE00514930
- Weight shell: H42149
- Gong: G46244

Code	Description	UOM	Price
H41708	Hermle 451.030H (55cm)	EACH	£165.00
H41709	Hermle 451.030H (66cm)	EACH	£165.00
H41710	Hermle 451.030H (94cm)	EACH	£165.00
H41711	Hermle 451.030H (114cm)	EACH	£165.00

**Hermle 451.033SK (Seconds)**

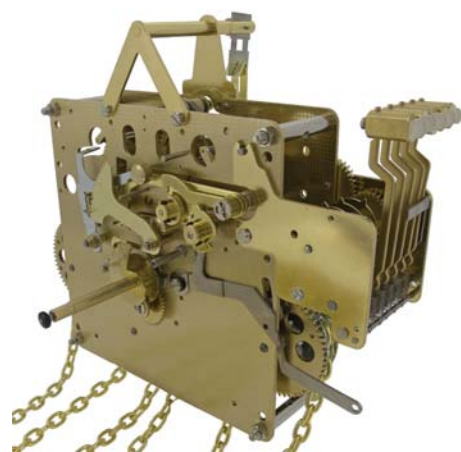

Hermle 451.033SK

8 day triple chime, weight driven clock movement with seconds feature

- 8 day
- Strike: Triple chime
- Hammers: 5 at the side
- Plate size: 120 x 120mm
- Anchor escapement, automatic beat
- Length A: 53.2mm (Plate to hand nut thread, see web diagram)
- Length B: 48.5mm (Shaft length, see web diagram)
- Mounting depth: 110mm (tip of handshaft to back of movement)
- Weight driven
- Pendulum length identification is stamped on the movement (pendulums supplied separately)
- Pendulum length in brackets
- Supplied with chime and strike shut off (silence) lever
- Supplied with pendulum leader (our code L9604)

Hermle state that in this combination, "S" means seconds feature and "K" is an engineering code and is irrelevant

Available separately:

- 2Kg weight: HERE00502700
- 2.89Kg weight: HERE00514930
- Weight shell: H42149
- Gong: G46244

Code	Description	UOM	Price
H41712	Hermle 451.033SK (94cm)	EACH	£185.00
H41713	Hermle 451.033SK (114cm)	EACH	£185.00

**Hermle 451.050 (Dead Beat)**

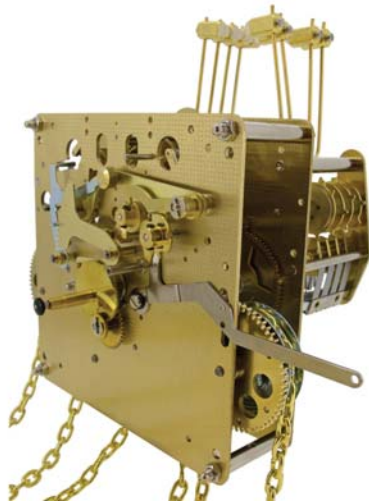

Hermle 451.050

Hermle movements with pendulum lengths 75cm or greater are no longer supplied with:

- Dead Beat - due to the size of the pendulum
- Low Bridge - due to the weight of the pendulum (alternatives are automatic beat and high bridge movements)

8 day triple chime, weight driven clock movement

- 8 day
- Strike: Triple chime
- Hammers: 8 behind
- Plate size: 120 x 120mm
- Anchor escapement, dead beat
- Length A: 33.2mm (Plate to hand nut thread, see web diagram)
- Length B: 28.5mm (Shaft length, see web diagram)
- Mounting depth: 155mm (tip of handshaft to back of movement)
- Weight driven
- Pendulum length identification is stamped on the movement (pendulums supplied separately)
- Pendulum length in brackets

Available separately:

- 2Kg weight: HERE00502700
- 2.89Kg weight: HERE00514930
- Weight shell: H42149
- Gong: G46248

Code	Description	UOM	Price
H48191	Hermle 451.050 (66cm) Dead Beat	EACH	£189.95

**Hermle 451.050H (High Bridge)**

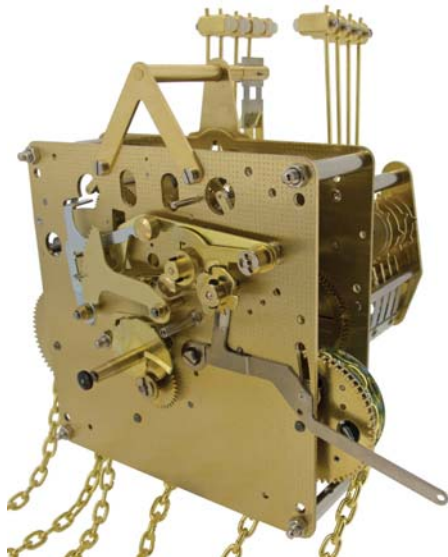

Hermle 451.050H

8 day triple chime, weight driven clock movement with high bridge

- 8 day
- Strike: Triple chime
- Hammers: 8 behind
- Plate size: 120 x 120mm
- Anchor escapement, automatic beat
- Length A: 33.2mm (Plate to hand nut thread, see web diagram)
- Length B: 28.5mm (Shaft length, see web diagram)
- Mounting depth: 155mm (tip of handshaft to back of movement)
- Weight driven
- Pendulum length identification is stamped on the movement (pendulums supplied separately)
- Pendulum length in brackets
- High bridge
- Supplied with chime and strike shut off (silence) lever
- Supplied with pendulum leader (our code L9604)

Hermle state that in this combination, "H" means high bridge

Available separately:

- 2Kg weight: HERE00502700
- 2.89Kg weight: HERE00514930
- Weight shell: H42149
- Gong: G46248

Code	Description	UOM	Price
H41717	Hermle 451.050H (75cm)	EACH	£166.95
H41719	Hermle 451.050H (85cm)	EACH	£166.95
H41721	Hermle 451.050H (94cm)	EACH	£166.95
H41714	Hermle 451.050H (114cm)	EACH	£166.95

**Hermle 451.053H (Auto Beat, High Bridge)**



Hermle 451.053H

- Automatic Beat
- High Bridge

8 day triple chime, weight driven clock movement with high bridge, 48.5mm shaft

- 8 day
- Strike: Triple chime
- Hammers: 8 behind
- Plate size: 120 x 120mm
- Anchor escapement, automatic beat
- Length A: 53.2mm (Plate to hand nut thread, see web diagram)
- Length B: 48.5mm (Shaft length, see web diagram)
- Mounting depth: 170mm (tip of handshaft to back of movement)
- Weight driven
- Pendulum length identification is stamped on the movement (pendulums supplied separately)
- Pendulum length in brackets
- High bridge
- Supplied with chime and strike shut off (silence) lever
- Supplied with pendulum leader (our code L9604)

Hermle state that in this combination, "H" means high bridge

Available separately:

- 2Kg weight: HERE00502700
- 2.89Kg weight: HERE00514930
- Weight shell: H42149
- Gong: G46248

Code	Description	UOM	Price
H40902	Hermle 451.053H (75cm)	EACH	£170.00
H8208	Hermle 451.053H (85cm)	EACH	£170.00
H40903	Hermle 451.053H (94cm)	EACH	£170.00
H40904	Hermle 451.053H (100cm)	EACH	£170.00
H40905	Hermle 451.053H (114cm)	EACH	£170.00

**Hermle 451.053HS (Auto Beat, High Bridge, Seconds)**

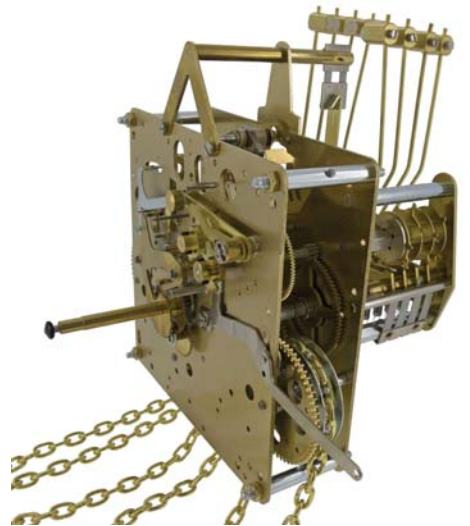

Hermle 451.053HS

- Auto Beat
- High Bridge
- Seconds

8 day triple chime, weight driven clock movement with high bridge, 48.5mm shaft with seconds

- 8 day
- Strike: Triple chime
- Hammers: 8 behind
- Plate size: 120 x 120mm
- Anchor escapement, automatic beat
- Length A: 53.2mm (Plate to hand nut thread, see web diagram)
- Length B: 48.5mm (Shaft length, see web diagram)
- Mounting depth: 170mm (tip of handshaft to back of movement)
- Weight driven
- Pendulum length identification is stamped on the movement (pendulums supplied separately)
- Pendulum length in brackets
- High bridge
- Seconds feature
- Supplied with chime and strike shut off (silence) lever
- Supplied with pendulum leader (our code L9604)

Hermle state that in this combination, "S" means seconds feature & "H" means high bridge

Available separately:

- 2Kg weight: HERE00502700
- 2.89Kg weight: HERE00514930
- Weight shell: H42149
- Gong: G46248

Code	Description	UOM	Price
H41734	Hermle 451.053HS (94cm)	EACH	£195.00
H41733	Hermle 451.053HS (114cm)	EACH	£195.00

**PRICE PROMISE GUARANTEE**



**Hermle 461.053DSK  
(Dead Beat, Seconds)**

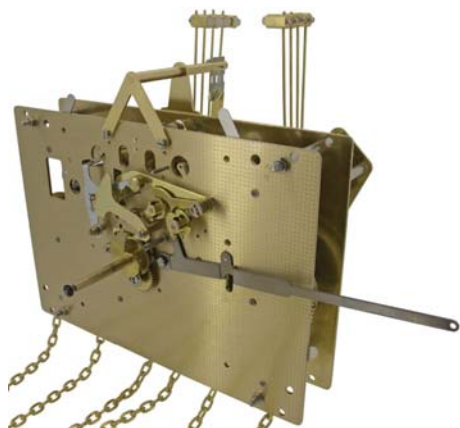

Hermle 461.053DSK

8 day Westminster, weight driven clock movement with seconds feature & a high bridge

- 8 day
- Strike: Westminster chime
- Hammers: 8 behind
- Plate size: 140 x 200mm
- Anchor escapement, dead beat
- Length A: 53.2mm (Plate to hand nut thread, see web diagram)
- Length B: 48.5mm (Shaft length, see web diagram)
- Mounting depth: 190mm (tip of handshaft to back of movement)
- Weight driven
- Pendulum length identification is stamped on the movement (pendulums supplied separately)
- Pendulum length in brackets
- Seconds feature
- Supplied with chime and strike shut off (silence) lever
- Supplied with pendulum leader (our code L9604)

Hermle state that in this combination, "D" & "K" are engineering codes and are irrelevant

- Available separately:
- 2.5Kg weight: W46182
  - 3.5Kg weight: H38196
  - Weight shell: H38198
  - Gong: G46249

Code	Description	UOM	Price
H41735	Hermle 461.053DSK (94cm)	EACH	£309.95
H41736	Hermle 461.053DSK (114cm)	EACH	£309.95

**Hermle 461.053H (High Bridge)**

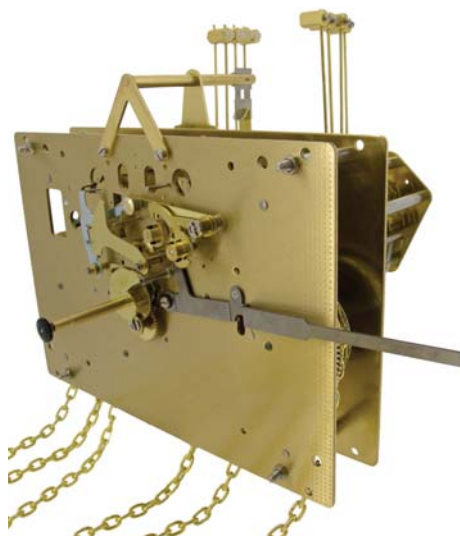

Hermle 461.053H

8 day Westminster, weight driven clock movement with high bridge

- 8 day

- Strike: Westminster chime
- Hammers: 8 behind
- Plate size: 140 x 200mm
- Anchor escapement, dead beat
- Length A: 53.2mm (Plate to hand nut thread, see web diagram)
- Length B: 48.5mm (Shaft length, see web diagram)
- Mounting depth: 190mm (tip of handshaft to back of movement)
- Weight driven
- Pendulum length identification is stamped on the movement (pendulums supplied separately)
- Pendulum length in brackets
- Supplied with pendulum leader (our code L9604)

Hermle state that in this combination, "H" means a high bridge

- Available separately:
- 2.5Kg weight: W46182
  - 3.5Kg weight: H38196
  - Weight shell: H38198
  - Gong: G46249

Code	Description	UOM	Price
H45722	Hermle 461.053H (94cm)	EACH	£215.00

**Hermle 461.850CSK (Seconds)**

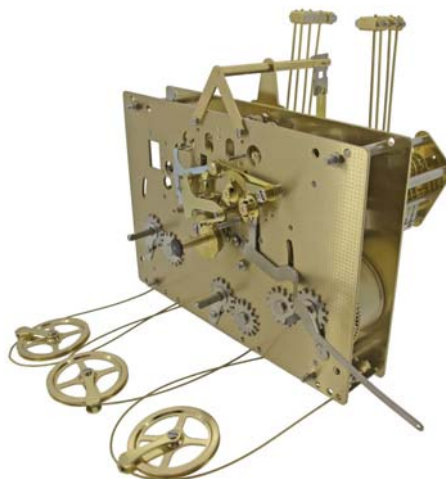

Hermle 461.850CSK

8 day Westminster, cable driven clock movement with seconds feature

- 8 day
- Strike: Westminster
- Hammers: 8 behind
- Plate size: 140 x 200mm
- Anchor escapement, automatic beat
- Length A: 33.2mm (Plate to hand nut thread, see web diagram)
- Length B: 28.5mm (Shaft length, see web diagram)
- Mounting depth: 200mm (tip of handshaft to back of movement)
- WH4: Winding hole configuration (see web diagram)
- Cable driven
- Pendulum length identification is stamped on the movement (pendulums supplied separately)
- Pendulum length in brackets
- Seconds feature
- Supplied with chime and strike shut off (silence) lever
- Supplied with pendulum leader (our code L9604)

Hermle state that in this combination, "S" means seconds feature and "C" & "K" are engineering codes and are irrelevant.

- Available separately:
- 3.5Kg weight: H38196
  - 4.5Kg weight: H38197
  - Weight shell: H38198
  - Gong: G46249

Code	Description	UOM	Price
H41738	Hermle 461.850CSK (94cm)	EACH	£270.00
H41737	Hermle 461.850CSK (114cm)	EACH	£270.00

**Hermle 461.853CSK (Seconds)**

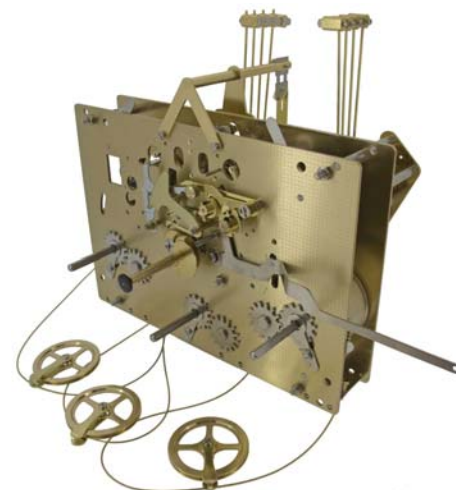

Hermle 461.853CSK

8 day Westminster, cable driven clock movement, 48.5mm shaft with seconds feature

- 8 day
- Strike: Westminster
- Hammers: 8 behind
- Plate size: 140 x 200mm
- Anchor escapement, automatic beat
- Length A: 53.2mm (Plate to hand nut thread, see web diagram)
- Length B: 48.5mm (Shaft length, see web diagram)
- Mounting depth: 230mm (tip of handshaft to back of movement)
- WH4: Winding hole configuration (see web diagram)
- Cable driven
- Pendulum length identification is stamped on the movement (pendulums supplied separately)
- Pendulum length in brackets
- Seconds feature
- Supplied with chime and strike shut off (silence) lever
- Supplied with pendulum leader (our code L9604)

Hermle state that in this combination, "S" means seconds feature and "C" & "K" are engineering codes and are irrelevant.

- Available separately:
- 3.5Kg weight: H38196
  - 4.5Kg weight: H38197
  - Weight shell: H38198
  - Gong: G46249

Code	Description	UOM	Price
H41739	Hermle 461.853CSK (94cm)	EACH	£270.00
H41740	Hermle 461.853CSK (114cm)	EACH	£270.00

**Hermle 461.853HS  
(Seconds, High Bridge)**



Hermle 461.853HS

8 day Westminster, cable driven clock movement, 48.5mm shaft with high bridge and seconds feature

- 8 day
- Strike: Westminster
- Hammers: 8 behind
- Plate size: 140 x 200mm
- Anchor escapement, automatic beat
- Length A: 53.2mm (Plate to hand nut thread, see web diagram)
- Length B: 48.5mm (Shaft length, see web diagram)
- Mounting depth: 230mm (tip of handshaft to back of movement)
- WH4: Winding hole configuration (see web diagram)
- Cable driven
- Pendulum length identification is stamped on the movement (pendulums supplied separately)
- Pendulum length in brackets
- High bridge
- Seconds feature
- Supplied with pendulum leader (our code L9604)

Hermle state that in this combination, "S" means seconds feature and "H" means high bridge

Available separately:

- 3.5Kg weight: H38196
- 4.5Kg weight: H38197
- Weight shell: H38198
- Gong: G46249

Code	Description	UOM	Price
H28889	Hermle 461.853HS (114cm)	EACH	£199.95

## Hermle 471.050S (Seconds)

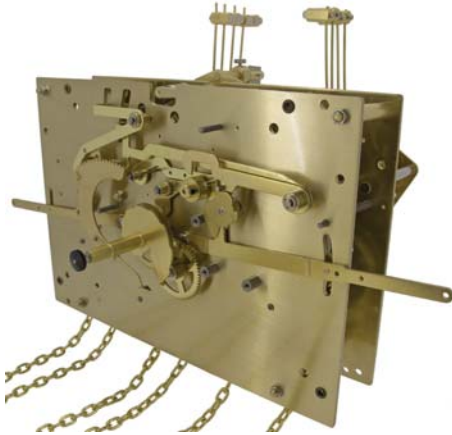

Hermle 471.050S

8 day Westminster chime, weight driven clock movement with seconds

- 8 day
- Strike: Westminster chime
- Hammers: 8 behind
- Plate size: 152 x 200
- Anchor escapement, automatic beat
- Length A: 55.5mm (Plate to hand nut thread, see web diagram)
- Length B: 48mm (Shaft length, see web diagram)
- Mounting depth: 200mm (tip of handshaft to back of movement)
- Weight driven
- Pendulum length identification is stamped on the movement (pendulums supplied separately)
- Pendulum length in brackets
- Seconds feature

Hermle state that in this combination, "S" means seconds feature

Available separately:

- 3.5Kg weight: H38196
- 4.5Kg weight: H38197
- Weight shell: H38198

• Gong: G46249

Code	Description	UOM	Price
H41741	Hermle 471.050S (94cm)	EACH	£450.00
H41742	Hermle 471.050S (114cm) with Automatic Night Shut Off	EACH	£450.00

## Hermle 471.890S (Seconds)

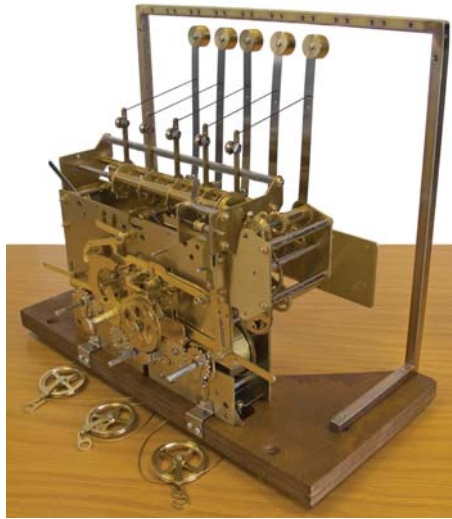

Hermle 471.890S

8 day Westminster chime, cable driven clock movement with seconds feature

- 8 day
- Strike: Westminster chime
- Tubes: 5 behind
- Plate size: 152 x 220
- Anchor escapement, automatic beat
- Length A: 55.5mm (Plate to hand nut thread, see web diagram)
- Length B: 48mm (Shaft length, see web diagram)
- Mounting depth: 270mm (tip of handshaft to back of movement)
- WH4: Winding hole configuration (see web diagram)
- Cable driven
- Pendulum length identification is stamped on the movement (pendulums supplied separately)
- Pendulum length in brackets
- Seconds feature
- Supplied with pendulum leader (our code L9604)

Hermle state that in this combination, "S" means seconds feature

Code	Description	UOM	Price
H41743	Hermle 471.890S (114cm)	EACH	£795.00

## Hermle 771.000

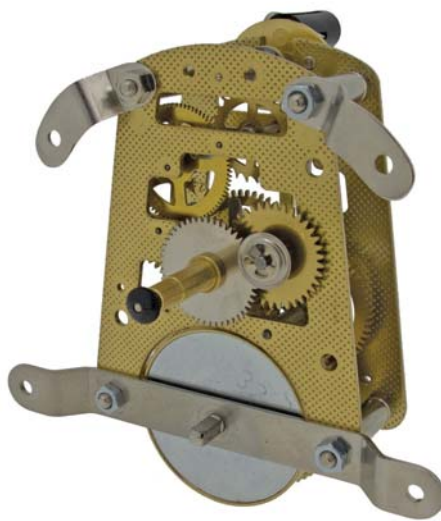

Hermle 771.000

8 day time only, key wound clock movement

- 8 day
- Time only
- Plate size: 77 x 58.5mm
- Anchor escapement, automatic beat
- Length A: 30.5mm (Plate to hand nut thread, see web diagram)

- Length B: 25.5mm (Shaft length, see web diagram)
- Mounting depth: 75mm (tip of handshaft to back of movement)
- Pendulum length identification is stamped on the movement (pendulums supplied separately)
- Pendulum length in brackets
- Supplied with pendulum leader (our code L7779)

Code	Description	UOM	Price
H8787	Hermle 771.000 (18cm)	EACH	£56.95
H40994	Hermle 771.000 (21cm)	EACH	£56.95
H40995	Hermle 771.000 (23cm)	EACH	£56.95
H8788	Hermle 771.000 (25cm)	EACH	£56.95
H40996	Hermle 771.000 (31cm)	EACH	£56.95
H40997	Hermle 771.000 (32.5cm)	EACH	£56.95
H40998	Hermle 771.000 (35cm)	EACH	£56.95
H40999	Hermle 771.000 (39cm)	EACH	£56.95
H41000	Hermle 771.000 (45cm)	EACH	£56.95
H41001	Hermle 771.000 (55cm)	EACH	£56.95

## Hermle 791.680



Hermle 791.680

14 day bell strike skeleton clock movement

- 14 day
- Strike: Bell strike
- Hammers: 1 at the side
- Plate size: 181 x 60mm
- Anchor escapement, automatic beat
- Length A: 33.2mm (Plate to hand nut thread, see web diagram)
- Length B: 28.5mm (Shaft length, see web diagram)
- Mounting depth: 95mm (tip of handshaft to back of movement)
- Pendulum length identification is stamped on the movement (pendulums supplied separately)
- Pendulum length in brackets
- Supplied with pendulum leader (our code HER29006)

Code	Description	UOM	Price
H791680	Hermle 791.680 (16.5cm)	EACH	£175.00
H40263	Hermle 791.680 (21cm)	EACH	£175.00
H40264	Hermle 791.680 (23cm)	EACH	£175.00
H40265	Hermle 791.680 (25cm)	EACH	£175.00
H40266	Hermle 791.680 (26.5cm)	EACH	£175.00
H40267	Hermle 791.680 (27cm)	EACH	£175.00
H40268	Hermle 791.680 (29cm)	EACH	£175.00
H40269	Hermle 791.680 (31cm)	EACH	£175.00
H40270	Hermle 791.680 (32cm)	EACH	£175.00
H40271	Hermle 791.680 (34cm)	EACH	£175.00
H40272	Hermle 791.680 (38cm)	EACH	£175.00
H40273	Hermle 791.680 (43cm)	EACH	£175.00
H40274	Hermle 791.680 (45cm)	EACH	£175.00

**Hermle 1050.020**

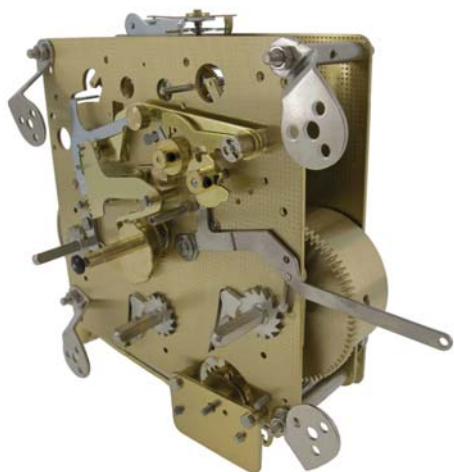

Hermle 1050.020  
8 day triple chime, key wound clock movement

- 8 day
- Strike: Triple chime
- Hammers: 8 below
- Plate size: 120 x 120mm
- Floating balance
- Length A: 33.2mm (Plate to hand nut thread, see web diagram)
- Length B: 28.5mm (Shaft length, see web diagram)
- Mounting depth: 105mm (tip of handshaft to back of movement)
- WH5: Winding hole configuration (see web diagram)
- Supplied with chime and strike shut off (silence) lever

Available Separately:

- Gong: G46246

Code	Description	UOM	Price
H41559	Hermle 1050.020	EACH	£235.00

**Hermle 1050.021**

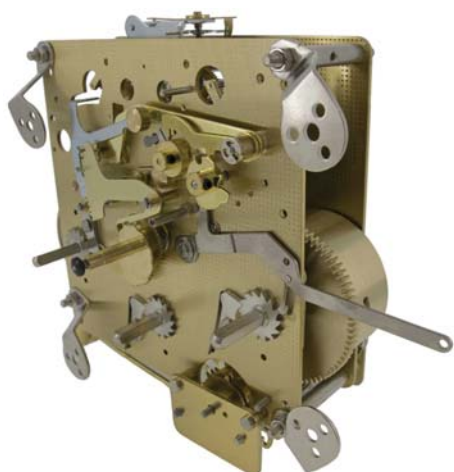

Hermle 1050.021  
8 day triple chime, key wound clock movement, 22.9mm shaft

- 8 day
- Strike: Triple chime
- Hammers: 8 below
- Plate size: 120 x 120mm
- Floating balance
- Length A: 27.6mm (Plate to hand nut thread, see web diagram)
- Length B: 22.9mm (Shaft length, see web diagram)
- Mounting depth: 95mm (tip of handshaft to back of movement)
- WH5: Winding hole configuration (see web diagram)
- Supplied with chime and strike shut off (silence) lever

Available Separately:

- Gong: G46246

Code	Description	UOM	Price
H41560	Hermle 1050.021	EACH	£230.00

**Hermle 1051.020**

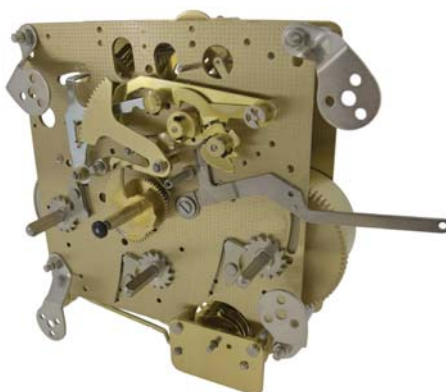

Hermle 1051.020  
8 day triple chime, key wound clock movement

- 8 day
- Strike: Triple chime
- Hammers: 8 below
- Plate size: 120 x 120mm
- Anchor escapement, automatic beat
- Length A: 33.2mm (Plate to hand nut thread, see web diagram)
- Length B: 28.5mm (Shaft length, see web diagram)
- Mounting depth: 120mm (tip of handshaft to back of movement)
- WH5: Winding hole configuration (see web diagram)
- Pendulum length identification is stamped on the movement (pendulums supplied separately)
- Pendulum length in brackets
- Supplied with chime and strike shut off (silence) lever
- Supplied with chime and strike shut off (silence) lever
- Supplied with pendulum leader (our code L9603)

Code	Description	UOM	Price
H41562	Hermle 1051.020 (15cm)	EACH	£199.95
H41563	Hermle 1051.020 (25cm)	EACH	£199.95
H41564	Hermle 1051.020 (31cm)	EACH	£199.95
H41565	Hermle 1051.020 (38cm)	EACH	£199.95
H41566	Hermle 1051.020 (43cm)	EACH	£199.95
H41567	Hermle 1051.020 (45cm)	EACH	£199.95
H41568	Hermle 1051.020 (48cm)	EACH	£199.95
H41569	Hermle 1051.020 (66cm)	EACH	£199.95

**Hermle 1051.030 (A)**

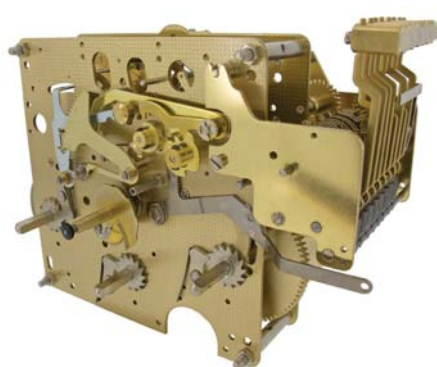

Hermle 1051.030 (Hermle 1051.030A)  
8 day triple chime, key wound clock movement

- 8 day
- Strike: Triple chime
- Hammers: 8 at the side
- Plate size: 120 x 120mm
- Anchor escapement, automatic beat
- Length A: 33.2mm (Plate to hand nut thread, see web diagram)
- Length B: 28.5mm (Shaft length, see web diagram)

- Mounting depth: 110mm (tip of handshaft to back of movement)
- WH5: Winding hole configuration (see web diagram)
- Pendulum length identification is stamped on the movement (pendulums supplied separately)
- Pendulum length in brackets
- Supplied with chime and strike shut off (silence) lever
- Supplied with pendulum leader (our code L9603)

Hermle state that the "A" after a calibre is an engineering code and is irrelevant

Available Separately:

- Gong: G46250

Code	Description	UOM	Price
H41570	Hermle 1051.030 (A) (32cm)	EACH	£264.95
H41571	Hermle 1051.030 (A) (34cm)	EACH	£264.95
H41572	Hermle 1051.030 (A) (38cm)	EACH	£264.95
H41573	Hermle 1051.030 (A) (43cm)	EACH	£264.95
H41574	Hermle 1051.030 (A) (45cm)	EACH	£264.95
H41575	Hermle 1051.030 (A) (48cm)	EACH	£264.95
H41576	Hermle 1051.030 (A) (55cm)	EACH	£264.95
H41577	Hermle 1051.030 (A) (66cm)	EACH	£264.95
H41578	Hermle 1051.030 (A) (75cm)	EACH	£264.95

**Hermle 1051.031 (A)**

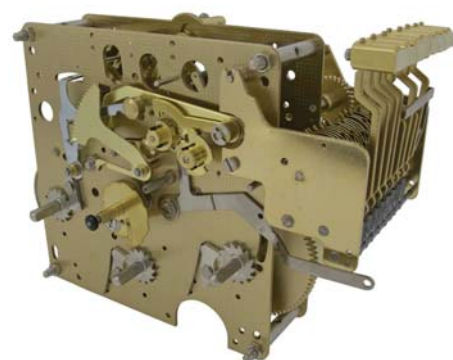

Hermle 1051.031 (1051.031A)  
8 day triple chime, key wound clock movement, 22.9mm shaft

- 8 day
- Strike: Triple chime
- Hammers: 8 at the side
- Plate size: 120 x 120mm
- Anchor escapement, automatic beat
- Length A: 27.6mm (Plate to hand nut thread, see web diagram)
- Length B: 22.9mm (Shaft length, see web diagram)
- Mounting depth: 105mm (tip of handshaft to back of movement)
- WH5: Winding hole configuration (see web diagram)
- Pendulum length identification is stamped on the movement (pendulums supplied separately)
- Pendulum length in brackets
- Supplied with chime and strike shut off (silence) lever
- Supplied with pendulum leader (our code L9604)

Hermle state that the "A" after a calibre is an engineering code and is irrelevant

Available Separately:

- Gong: G46250

Code	Description	UOM	Price
H41579	Hermle 1051.031 (A) (25cm)	EACH	£199.95
H41580	Hermle 1051.031 (A) (34cm)	EACH	£199.95
H41581	Hermle 1051.031 (A) (38cm)	EACH	£199.95
H41582	Hermle 1051.031 (A) (55cm)	EACH	£199.95



**Hermle 1051.051**

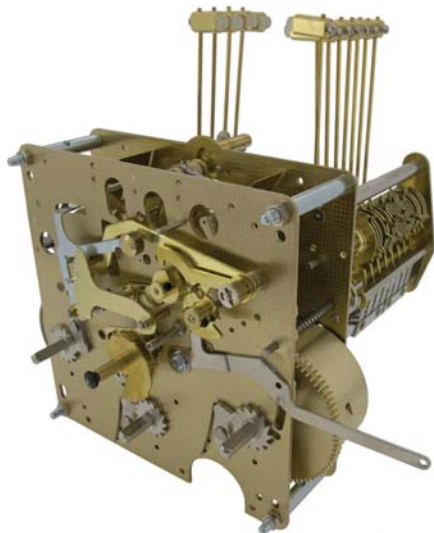

Hermle 1051.051

8 day triple chime, key wound clock movement, 22.9mm shaft

- 8 day
- Strike: Triple chime
- Hammers: 12 behind
- Plate size: 120 x 120mm
- Anchor escapement, automatic beat
- Length A: 27.6mm (Plate to hand nut thread, see web diagram)
- Length B: 22.9mm (Shaft length, see web diagram)
- Mounting depth: 110mm (tip of handshaft to back of movement)
- WH5: Winding hole configuration (see web diagram)
- Pendulum length identification is stamped on the movement (pendulums supplied separately)
- Pendulum length in brackets
- Supplied with chime and strike shut off (silence) lever
- Supplied with pendulum leader (our code L9603)

Available Separately:

- Gong: H28888

Code	Description	UOM	Price
H41583	Hermle 1051.051 (43cm)	EACH	£230.00
H41584	Hermle 1051.051 (48cm)	EACH	£230.00
H41585	Hermle 1051.051 (75cm)	EACH	£230.00

**Hermle 1151.050H (High Bridge)**

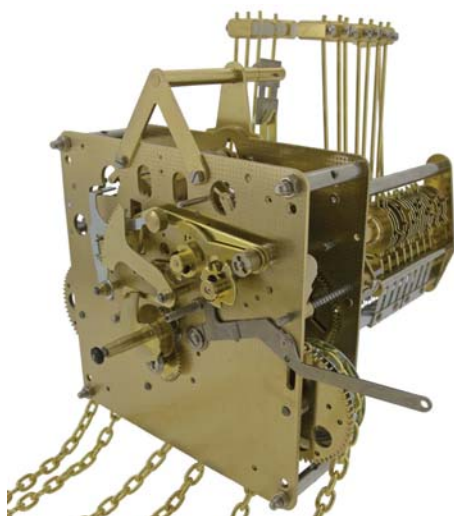

Hermle 1151.050H

8 day triple chime, weight driven clock movement with high bridge

- 8 day
- Strike: Triple chime
- Hammers: 12 behind
- Plate size: 120 x 120mm

- Anchor escapement, automatic beat
- Length A: 33.2mm (Plate to hand nut thread, see web diagram)
- Length B: 28.5mm (Shaft length, see web diagram)
- Mounting depth: 190mm (tip of handshaft to back of movement)
- Weight driven
- Pendulum length identification is stamped on the movement (pendulums supplied separately)
- Pendulum length in brackets
- High bridge
- Supplied with chime and strike shut off (silence) lever
- Supplied with pendulum leader (our code L9604)

Hermle state that in this combination, "H" means high bridge

Available separately:

- 2Kg weight: HERE00502700
- 3.3Kg weight: H38202
- Weight shell: H38201
- Gong: H28888

Code	Description	UOM	Price
H41587	Hermle 1151.050H (85cm)	EACH	£215.00
H41588	Hermle 1151.050H (94cm)	EACH	£215.00
H41586	Hermle 1151.050H (114cm)	EACH	£215.00

**Hermle 1151.050HS (High Bridge, Seconds)**

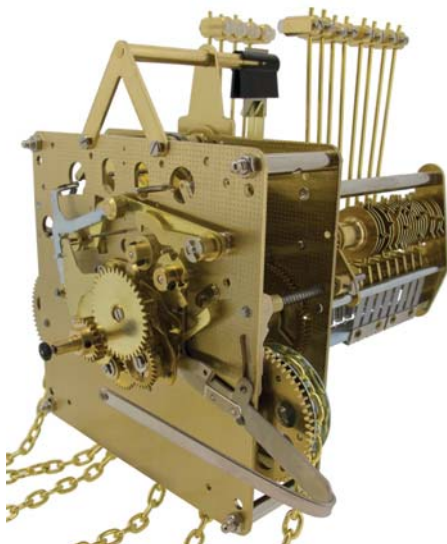

Hermle 1151.050

8 day triple chime, weight driven clock movement with seconds feature

- 8 day
- Strike: Triple chime
- Hammers: 12 behind
- Plate size: 120 x 120mm
- Anchor escapement, automatic beat
- Length A: 33.2mm (Plate to hand nut thread, see web diagram)
- Length B: 28.5mm (Shaft length, see web diagram)
- Mounting depth: 190mm (tip of handshaft to back of movement)
- Weight driven
- Pendulum length identification is stamped on the movement (pendulums supplied separately)
- Pendulum length in brackets
- Supplied with chime and strike shut off (silence) lever
- Supplied with pendulum leader (our code L9604)

Available separately:

- 2Kg weight: HERE00502700
- 3.3Kg weight: H38202
- Weight shell: H38201
- Gong: H28888

Code	Description	UOM	Price
H41589	Hermle 1151.050HS (94cm)	EACH	£195.00

**Hermle 1151.053H (High Bridge)**



Hermle 1151.053H

8 day triple chime, weight driven clock movement with high bridge

- 8 day
- Strike: Triple chime
- Hammers: 12 behind
- Plate size: 120 x 120mm
- Anchor escapement, automatic beat
- Length A: 53.2mm (Plate to hand nut thread, see web diagram)
- Length B: 48.5mm (Shaft length, see web diagram)
- Mounting depth: 200mm (tip of handshaft to back of movement)
- Weight driven
- Pendulum length identification is stamped on the movement (pendulums supplied separately)
- Pendulum length in brackets
- High bridge
- Supplied with chime and strike shut off (silence) lever
- Supplied with pendulum leader (our code L9604)

Hermle state that in this combination, "H" means high bridge

Available separately:

- 2Kg weight: HERE00502700
- 3.3Kg weight: H38202
- Weight shell: H38201
- Gong: H28888

Code	Description	UOM	Price
H41002	Hermle 1151.053H (75cm)	EACH	£179.95
H41003	Hermle 1151.053H (85cm)	EACH	£179.95
H41004	Hermle 1151.053H (94cm)	EACH	£179.95
H41005	Hermle 1151.053H (100cm)	EACH	£179.95
H8213	Hermle 1151.053H (114cm)	EACH	£179.95

**Deadbeat v Automatic Beat**

*Automatic beat escapement movements are for narrow waste (pinch waste) grandfather/grandmother clock cases. With automatic beat the case has to be wide enough for the customer to over swing the pendulum when starting the clock. If the clock has a narrow waste it can happen that the dead beat is the only option because the dead beat does not require room for over swing.*

**Hermle 1151.053H (Dead Beat, High Bridge)**



Hermle 1151.053H

8 day triple chime, weight driven clock movement with high bridge, dead beat

- 8 day
- Strike: Triple chime
- Hammers: 12 behind
- Plate size: 120 x 120mm
- Anchor escapement, dead beat
- Length A: 53.2mm (Plate to hand nut thread, see web diagram)
- Length B: 48.5mm (Shaft length, see web diagram)
- Mounting depth: 200mm (tip of handshaft to back of movement)
- Weight driven
- Pendulum length identification is stamped on the movement (pendulums supplied separately)
- Pendulum length in brackets
- High bridge
- Supplied with chime and strike shut off (silence) lever

Hermle state that in this combination, "H" means high bridge

Available separately:

- 2Kg weight: HERE00502700
- 3.3Kg weight: H38202
- Weight shell: H38201
- Gong: H28888

Code	Description	UOM	Price
H41885	Hermle 1151.053H (114cm)	EACH	£190.00

**Hermle 1151.053SK / 1151.053HS (Seconds)**

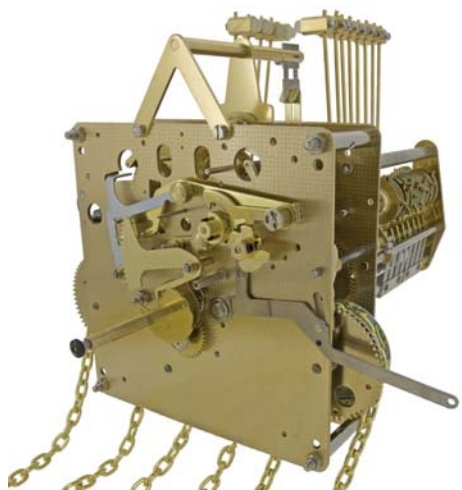

Hermle 1151.053SK

8 day triple chime, weight driven clock movement with seconds feature

- 8 day

- Strike: Triple chime
- Hammers: 12 behind
- Plate size: 120 x 120mm
- Anchor escapement, automatic beat
- Length A: 53.2mm (Plate to hand nut thread, see web diagram)
- Length B: 48.5mm (Shaft length, see web diagram)
- Mounting depth: 200mm (tip of handshaft to back of movement)
- Weight driven
- Pendulum length identification is stamped on the movement (pendulums supplied separately)
- Pendulum length in brackets
- Seconds feature
- Plate can be stamped either 1151.053SK or 1161.853HS. The movements are functionally the same
- Supplied with chime and strike shut off (silence) lever
- Supplied with pendulum leader (our code L9604)

Hermle state that in this combination, "S" means seconds feature and "K" is an engineering code and is irrelevant

Hermle state that in this combination, "H" means high bridge and "S" is seconds feature

Available separately:

- 2Kg weight: HERE00502700
- 3.3Kg weight: H38202
- Weight shell: H38201
- Gong: H28888

Code	Description	UOM	Price
H41591	Hermle 1151.053SK (114cm)	EACH	£195.00
H41590	Hermle 1151.053SK (114cm)	EACH	£195.00

**Hermle 1161.053H**

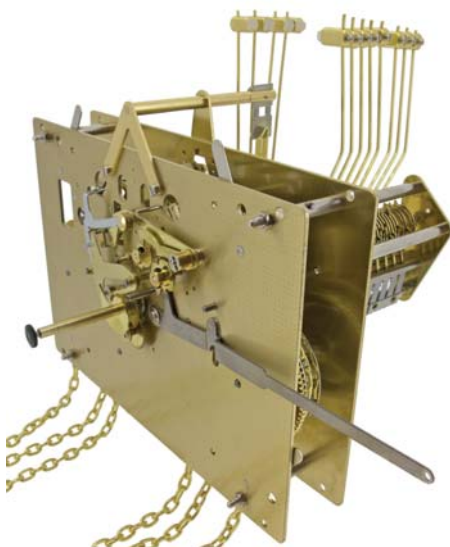

Hermle 1161.053H

8 day triple chime, weight driven clock movement

- 8 day
- Strike: Triple chime
- Hammers: 12 behind
- Plate size: 140 x 200mm
- Anchor escapement, automatic beat
- Length A: 53.2mm (Plate to hand nut thread, see web diagram)
- Length B: 48.5mm (Shaft length, see web diagram)
- Mounting depth: 200mm (tip of handshaft to back of movement)
- Weight driven
- Pendulum length identification is stamped on the movement (pendulums supplied separately)
- Pendulum length in brackets
- Supplied with chime and strike shut off (silence) lever
- Supplied with pendulum leader (our code L9604)

Hermle state that in this combination, "H" means high bridge

Available separately:

- 2.5Kg weight: W46182
- 4.5Kg weight: H38197
- Weight shell: H38198

- Gong: G8868

Code	Description	UOM	Price
H46132	Hermle 1161.053H (94cm)	EACH	£199.95

**Hermle 1161.053HS / 1151.053DSK (Seconds)**

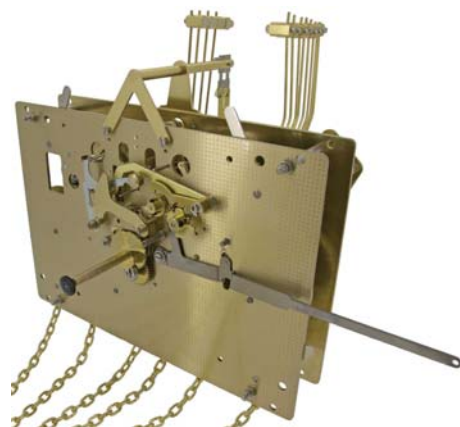

Hermle 1161.053DSK

8 day triple chime, weight driven clock movement with seconds feature

- 8 day
- Strike: Triple chime
- Hammers: 12 behind
- Plate size: 140 x 200mm
- Anchor escapement, automatic beat
- Length A: 53.2mm (Plate to hand nut thread, see web diagram)
- Length B: 48.5mm (Shaft length, see web diagram)
- Mounting depth: 200mm (tip of handshaft to back of movement)
- Weight driven
- Pendulum length identification is stamped on the movement (pendulums supplied separately)
- Pendulum length in brackets
- Plate can be stamped either 1161.053HS or 1161.053DSK. The movements are functionally the same
- Supplied with chime and strike shut off (silence) lever
- Supplied with pendulum leader (our code L9604)

Hermle state that in this combination, "H" means high bridge and "S" is seconds feature

Hermle state that in this combination, "S" means seconds feature and "D" & "K" are engineering codes and are irrelevant

Available separately:

- 2.5Kg weight: W46182
- 4.5Kg weight: H38197
- Weight shell: H38198
- Gong: G8868

Code	Description	UOM	Price
H41593	Hermle 1161.053HS (94cm)	EACH	£250.00
H41592	Hermle 1161.053HS (114cm)	EACH	£250.00

*Pendulum Lengths*

*The Hermle pendulum length is stamped on the back of the movement, next to or underneath the calibre. The "cm" length is measured from the top of the clock movement to the bottom of the pendulum.*

**Hermle 1161.850CSK (Seconds)**

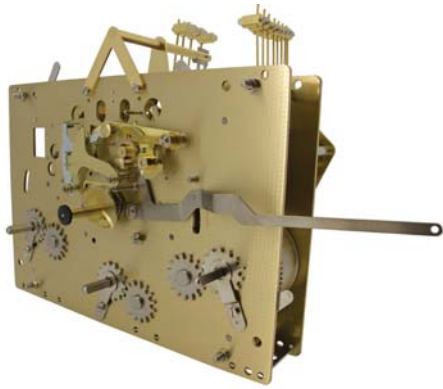

Hermle 1161.850CSK

8 day triple chime, cable driven clock movement with seconds feature

- 8 day
- Strike: Triple chime
- Hammers: 12 behind
- Plate size: 140 x 200mm
- Anchor escapement, automatic beat
- Length A: 33.2mm (Plate to hand nut thread, see web diagram)
- Length B: 28.5mm (Shaft length, see web diagram)
- Mounting depth: 210mm (tip of handshaft to back of movement)
- Cable driven
- Pendulum length identification is stamped on the movement (pendulums supplied separately)
- Pendulum length in brackets
- Seconds feature
- Supplied with chime and strike shut off (silence) lever
- Supplied with pendulum leader (our code L9604)

Hermle state that in this combination, "S" means seconds feature and "C" & "K" are engineering codes and are irrelevant

- Available separately:
- 2.5Kg weight: W46182
  - 4.5Kg weight: H38197
  - Weight shell: H38198

Code	Description	UOM	Price
H41595	Hermle 1161.850CSK (94cm)	EACH	£265.00
H41594	Hermle 1161.850CSK (114cm)	EACH	£265.00

**Hermle 1161.853HS / 1161.853CSK (Seconds)**

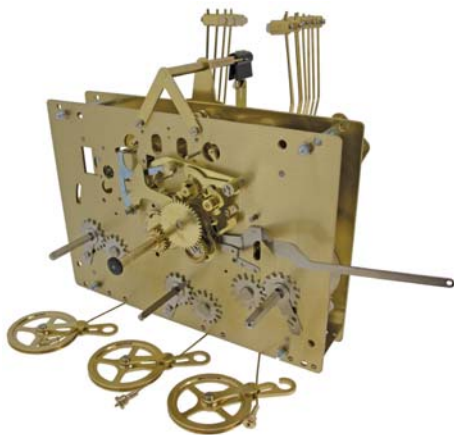

Hermle 1161.853HS / 1161.853CSK

8 day triple chime, cable driven clock movement with high bridge & seconds feature, 48.5mm shaft

- 8 day
- Strike: Triple chime
- Hammers: 12 behind
- Plate size: 140 x 200mm
- Anchor escapement, automatic beat
- Length A: 53.2mm (Plate to hand nut thread, see web diagram)
- Length B: 48.5mm (Shaft length, see web diagram)

- Mounting depth: 220mm (tip of handshaft to back of movement)
- Cable driven
- Pendulum length identification is stamped on the movement (pendulums supplied separately)
- Pendulum length in brackets
- Seconds feature
- Plate can be stamped either 1161.853HS or 1161.853CSK. The movements are functionally the same
- Supplied with chime and strike shut off (silence) lever
- Also supplied with automatic night shut off if specified
- Supplied with pendulum leader (our code L9604)

Hermle state that in this combination, "S" means seconds feature and "C" & "K" are engineering codes and are irrelevant.

Hermle state that "H" means high bridge & "S" means seconds feature.

- Available separately:
- 2.5Kg weight: W46182
  - 4.5Kg weight: H38197
  - Weight shell: H38198
  - Gong: G8868

Code	Description	UOM	Price
H41007	Hermle 1161.853HS (85cm)	EACH	£295.00
H41008	Hermle 1161.853HS (94cm)	EACH	£295.00
H41784	Hermle 1161.853HS (94cm) with Automatic Night Shut Off	EACH	£295.00
H41009	Hermle 1161.853HS (100cm)	EACH	£295.00
H8992	Hermle 1161.853HS (114cm)	EACH	£295.00
H41783	Hermle 1161.853HS (114cm) with Automatic Night Shut Off	EACH	£295.00

**Hermle 1171.050S (Seconds)**

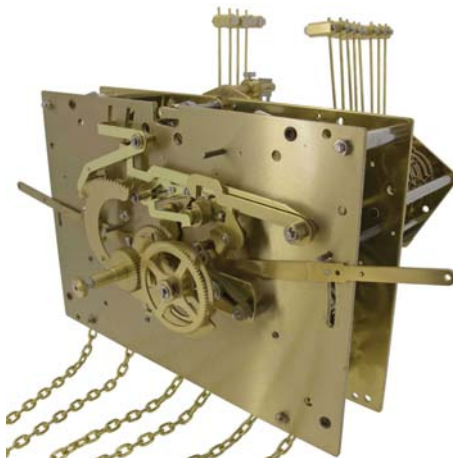

Hermle 1171.050S

8 day triple chime, weight driven clock movement with seconds

- 8 day
- Strike: Triple chime
- Hammers: 12 behind
- Plate size: 152 x 220mm
- Anchor escapement, automatic beat
- Length A: 55.5mm (Plate to hand nut thread, see web diagram)
- Length B: 48mm (Shaft length, see web diagram)
- Mounting depth: 235mm (tip of handshaft to back of movement)
- Weight driven
- Pendulum length identification is stamped on the movement (pendulums supplied separately)
- Pendulum length in brackets
- Seconds feature
- Supplied with automatic night shut off
- Supplied with pendulum leader (our code L9604)

Hermle state that in this combination, "S" means seconds feature

- Available separately:
- 3.5Kg weight: H38196
  - 4.5Kg weight: H38197
  - Weight shell: H38198

- Gong: G8868

Code	Description	UOM	Price
H41597	Hermle 1171.050S (94cm)	EACH	£365.00
H41596	Hermle 1171.050S (114cm)	EACH	£365.00

**Hermle 1171.850S (Seconds)**

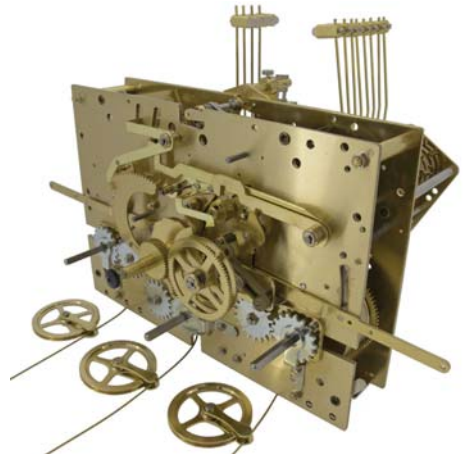

Hermle 1171.850S

8 day triple chime, cable driven clock movement with seconds

- 8 day
- Strike: Triple chime
- Hammers: 12 behind
- Plate size: 152 x 220mm
- Anchor escapement, automatic beat
- Length A: 55.5mm (Plate to hand nut thread, see web diagram)
- Length B: 48mm (Shaft length, see web diagram)
- Mounting depth: 235mm (tip of handshaft to back of movement)
- WH4: Winding hole configuration (see web diagram)
- Cable driven
- Pendulum length identification is stamped on the movement (pendulums supplied separately)
- Pendulum length in brackets
- Seconds feature
- Supplied with automatic night shut off
- Supplied with pendulum leader (our code L9604)

Hermle state that in this combination, "S" means seconds feature

- Available separately:
- 3.5Kg weight: H38196
  - 4.5Kg weight: H38197
  - Weight shell: H38198
  - Gong: G8868

Code	Description	UOM	Price
H41599	Hermle 1171.850S (94cm)	EACH	£555.00
H41598	Hermle 1171.850S (114cm)	EACH	£555.00

**Hermle Clock Movement Service Manual**



Ref: H31543  
See Page: 1376

**PRICE PROMISE GUARANTEE**

**Hermle 1171.890S (Seconds)**

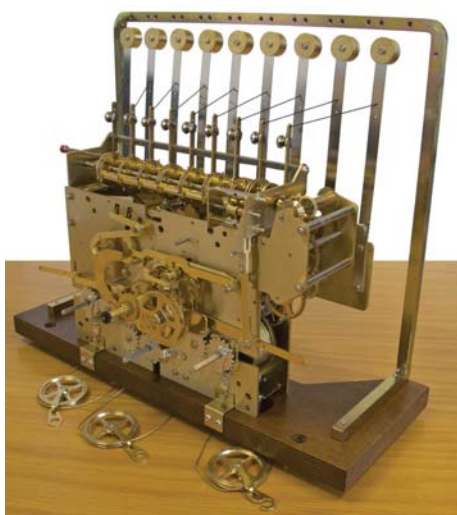

Hermle 1171.890

8 day triple chime, cable driven clock movement with seconds

- 8 day
- Strike: Triple chime
- 9 Tubular strike
- Plate size: 152 x 220mm
- Anchor escapement, automatic beat
- Length A: 55.5mm (Plate to hand nut thread, see web diagram)
- Length B: 48mm (Shaft length, see web diagram)
- Mounting depth: 270mm (tip of handshaft to back of movement)
- Cable driven
- Pendulum length identification is stamped on the movement (pendulums supplied separately)
- Pendulum length in brackets
- Seconds feature
- Supplied with automatic night shut off
- Supplied with pendulum leader (our code L9604)

Hermle state that in this combination, "S" means seconds feature

Available separately:

- 3.5Kg weight: H38196
- 8.4Kg weight: W46180
- Weight shell: H46185

Code	Description	UOM	Price
H41600	Hermle 1171.890S (114cm)	EACH	£850.00

**MOVEMENTS (MECHANICAL) KIENINGER**



*Kieninger recommend that replacing a Kieninger clock movement is often quicker and more cost effective than servicing or repairing an old one. Using a new movement ensures you take full advantage of the advances in manufacturing technology. They state that their movements are ready to fit, however some lubrication may be required.*

**Movement Required:**

*If you require a complete movement which is not listed below you can request a quote via our Kieninger movement parts search category by searching and selecting "movement" in the Kieninger clock part description look up and then add it as a non listed item, you will need to provide the pendulum length you require in the description field.*

**Pendulum Length:**

*The Kieninger pendulum length is stamped on the back of the movement, next to or underneath the calibre. The "cm" length is measured from the hand shaft centre to the centre of the pendulum disc (bob).*

**Trouble identifying your Kieninger movement?**

*If you are having trouble matching your existing Kieninger movement with the stocked movements below, please submit an online support request via "products & stock - missing item specification". Please provide the numbers/letters stamped on the plate as well as the plate size, the chime and the hand shaft length.*

- Hand shaft length: 31.80mm (plate to hand nut thread)

See our document download section for Kieninger technical documents

Code	Description	UOM	Price
K47718	Kieninger AEL01	EACH	£210.00

**Kieninger J0208**



¼ Hour triple chime, key wound clock movement

- ¼ Hour movement
- Strike: Triple chime
- Hammers: 8 below
- Plate size: 100 x 104mm
- 6 bronze bushes
- 11 Jewel Swiss escapement with Incablock shock resistance, gold plated
- Hand shaft length: 27.80mm (plate to hand nut thread)
- Automatic night shut off
- Seconds feature
- Back winding
- Permanent automatic night time shut off between 10pm & 7:15am

See our document download section for Kieninger technical documents

Code	Description	UOM	Price
K47723	Kieninger J0208	EACH	£665.00

**Kieninger J0221**



¼ Hour triple chime, key wound clock movement

- ¼ Hour movement
- Strike: Triple chime (Westminster, St. Michael & Whittingdon)
- Hammers: 8 below
- Plate size: 100 x 104mm
- 6 bronze bushes



**Mechanical Pendulum Clock Regulating Stand**

**Ref: S32057**  
**See Page: 929**

**Kieninger AEL01**

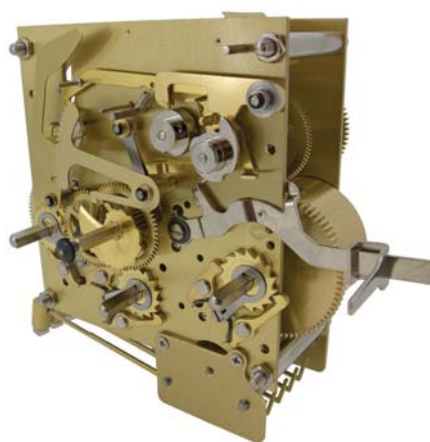

¼ Hour Westminster chime, key wound clock movement

- ¼ Hour movement
- Strike: Westminster chime
- Hammers: 5 below
- Plate size: 100 x 104mm
- 6 bronze bushes
- 5 Jewel Swiss escapement

**PRICE PROMISE GUARANTEE** 

# MOVEMENTS (MECHANICAL) KIENINGER

- 11 Jewel Swiss escapement with Incablock shock resistance, gold plated
- Hand shaft length: 35.80mm (plate to hand nut thread)
- Seconds feature
- Permanent automatic night time shut off between 10pm & 7:15am

See our document download section for Kieninger technical documents

Code	Description	UOM	Price
K47728	Kieninger J0221	EACH	£635.00

## Kieninger J1236

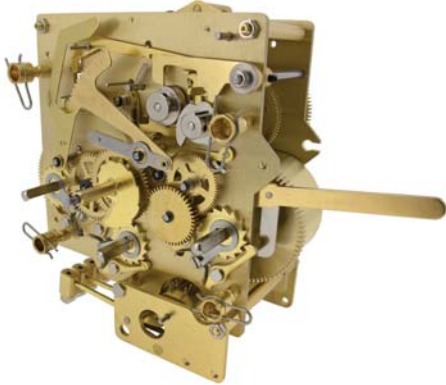

¼ Hour triple chime, key wound clock movement

- ¼ Hour movement
- Strike: Triple chime (Westminster, St. Michael & Whittingdon)
- Hammers: 8 below
- Plate size: 100 x 104mm
- 6 bronze bushes
- Hand shaft length: 31.80mm (plate to hand nut thread)
- Pendulum length identification is stamped on the movement (pendulums supplied separately)
- Pendulum length in brackets
- Permanent automatic night time shut off between 10pm & 7:15am
- Seconds feature
- Supplied with pendulum leader

See our document download section for Kieninger technical documents

Code	Description	UOM	Price
K47724	Kieninger J1236 (43cm)	EACH	£415.00

## Kieninger KSU33 (KSU Series)

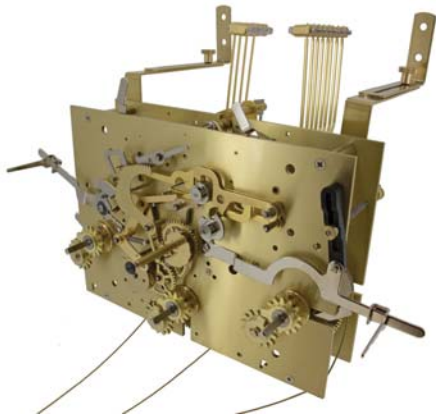

¼ Hour Triple chime, cable driven clock movement

KSU33 stamped on the plate.

Kieninger state that this movement is interchangeable with all KSU movements with the same pendulum length & hand shaft length (a different number after the KSU denotes an amendment to the movement such

as different mounting brackets and does not effect the main features of the movement)

- ¼ Hour movement
- Strike: Triple chime (Westminster, St. Michael & Whittingdon)
- Hammers: 12 above
- Plate size: 142 x 200mm
- 6 bronze bushes
- Hand shaft length: 47.80mm (plate to hand nut thread)
- Pendulum length 116cm
- Pendulum length in brackets
- Pendulum length identification is stamped on the movement (pendulums supplied separately)
- Automatic night shut off
- Seconds feature
- Maintaining power (will maintain power whilst winding, meaning no time is lost)
- Supplied with pendulum leader

See our document download section for Kieninger technical documents

Code	Description	UOM	Price
K47730	Kieninger KSU33 (116cm)	EACH	£450.00

## Kieninger KSU36 (KSU Series)

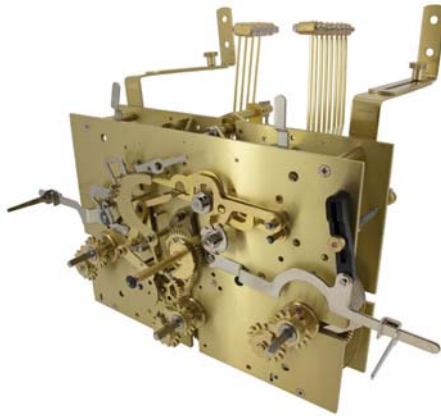

¼ Hour Triple chime, cable driven clock movement

KSU36 stamped on the plate.

Kieninger state that this movement is interchangeable with all KSU movements with the same pendulum length & hand shaft length (a different number after the KSU denotes an amendment to the movement such as different mounting brackets and does not effect the main features of the movement)

- ¼ Hour movement
- Strike: Triple chime (Westminster, St. Michael & Whittingdon)
- Hammers: 12 above
- Plate size: 142 x 200mm
- 6 bronze bushes
- Hand shaft length: 47.80mm (plate to hand nut thread)
- Pendulum length 100cm
- Pendulum length in brackets
- Pendulum length identification is stamped on the movement (pendulums supplied separately)
- Automatic night shut off
- Seconds feature
- Maintaining power (will maintain power whilst winding, meaning no time is lost)
- Supplied with pendulum leader

See our document download section for Kieninger technical documents

Code	Description	UOM	Price
K47731	Kieninger KSU36 (100cm)	EACH	£450.00

## Kieninger KSU50 (KSU Series)

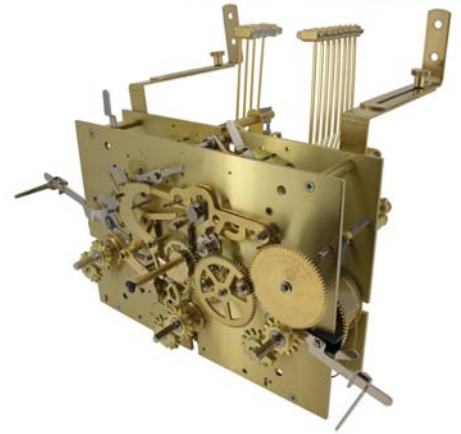

¼ Hour Triple chime, cable driven clock movement

KSU50 stamped on the plate.

Kieninger state that this movement is interchangeable with all KSU movements with the same pendulum length & hand shaft length (a different number after the KSU denotes an amendment to the movement such as different mounting brackets and does not effect the main features of the movement)

- ¼ Hour movement
- Strike: Triple chime (Westminster, St. Michael & Whittingdon)
- Hammers: 12 above
- Plate size: 142 x 200mm
- 6 bronze bushes
- Hand shaft length: 47.80mm (plate to hand nut thread)
- Pendulum length 116cm
- Pendulum length in brackets
- Pendulum length identification is stamped on the movement (pendulums supplied separately)
- Automatic night shut off
- Seconds feature
- Maintaining power (will maintain power whilst winding, meaning no time is lost)
- Automatic chime sequence (chime automatically changes every hour)
- Supplied with pendulum leader

See our document download section for Kieninger technical documents

Code	Description	UOM	Price
K47726	Kieninger KSU50 (116cm)	EACH	£495.00

## Kieninger KSU60 (KSU Series)

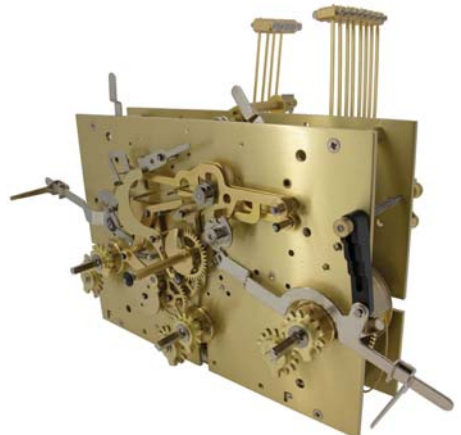

¼ Hour Triple chime, cable driven clock movement

KSU60 stamped on the plate.

Kieninger state that this movement is interchangeable with all KSU movements with the same pendulum length & hand shaft length (a different number after





the KSU denotes an amendment to the movement such as different mounting brackets and does not effect the main features of the movement)

- ¼ Hour movement
- Strike: Triple chime (Westminster, St. Michael & Whittingdon)
- Hammers: 12 above
- Plate size: 142 x 200mm
- 6 bronze bushes
- Hand shaft length: 47.80mm (plate to hand nut thread)
- Pendulum length 116cm
- Pendulum length in brackets
- Pendulum length identification is stamped on the movement (pendulums supplied separately)
- Automatic night shut off
- Seconds feature
- Maintaining power (will maintain power whilst winding, meaning no time is lost)
- Supplied with pendulum leader

Code	Description	UOM	Price
K47727	Kieninger KSU60 (116cm)	EACH	£450.00

### Kieninger MS008 (MS Series)

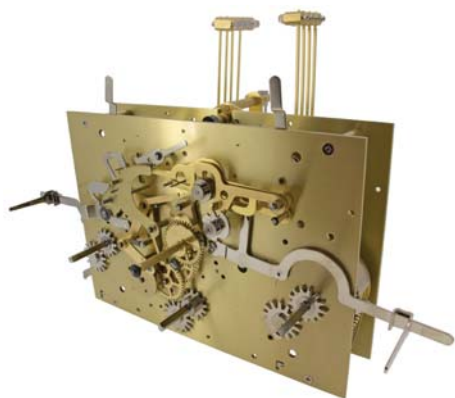

¼ Hour Westminster chime, cable driven clock movement

MS008 stamped on the plate.

Kieninger state that this movement is interchangeable with all MS movements with the same pendulum length & hand shaft length (a different number after the MS denotes an amendment to the movement such as different mounting brackets and does not effect the main features of the movement)

- ¼ Hour movement
- Strike: Westminster chime
- Hammers: 8 above
- Plate size: 142 x 200mm
- Hand shaft length: 47.80mm (plate to hand nut thread)
- Pendulum length 116cm
- Pendulum length in brackets
- Pendulum length identification is stamped on the movement (pendulums supplied separately)
- Automatic night shut off
- Supplied with pendulum leader

See our document download section for Kieninger technical documents

Code	Description	UOM	Price
K47720	Kieninger MS008 (116cm)	EACH	£250.00



**ORDER tracking**

### Kieninger MSU13 (MSU Series)



¼ Hour Triple chime, cable driven clock movement

MSU13 stamped on the plate.

Kieninger state that this movement is interchangeable with all MSU movements with the same pendulum length & hand shaft length (a different number after the MSU denotes an amendment to the movement such as different mounting brackets and does not effect the main features of the movement)

- ¼ Hour movement
- Strike: Triple chime (Westminster, St. Michael & Whittingdon)
- Hammers: 12 above
- Plate size: 142 x 200mm
- 6 bronze bushes
- Hand shaft length: 47.80mm (plate to hand nut thread)
- Pendulum length 116cm
- Pendulum length in brackets
- Pendulum length identification is stamped on the movement (pendulums supplied separately)
- Supplied with pendulum leader

See our document download section for Kieninger technical documents

Code	Description	UOM	Price
K47721	Kieninger MSU13 (116cm)	EACH	£270.00

### Kieninger PS026 (PS Series)



½ Hour bam chime, key wind clock movement

PS026 stamped on the plate.

Kieninger state that this movement is interchangeable with all PS movements with the same pendulum length & hand shaft length (a different number after the PS denotes an amendment to the movement such as

different mounting brackets and does not effect the main features of the movement)

- ½ Hour movement
- Strike: Bam (Coil gong)
- Hammers: 1 at the side
- Plate size: 114 x 99mm
- 4 bronze bushes
- Hand shaft length: 31.80mm (plate to hand nut thread)
- Pendulum length identification is stamped on the movement (pendulums supplied separately)
- Pendulum length in brackets
- Seconds feature
- Supplied with pendulum leader

See our document download section for Kieninger technical documents

Code	Description	UOM	Price
K47725	Kieninger PS026 (65cm)	EACH	£235.00

### Kieninger PS055 (PS Series)

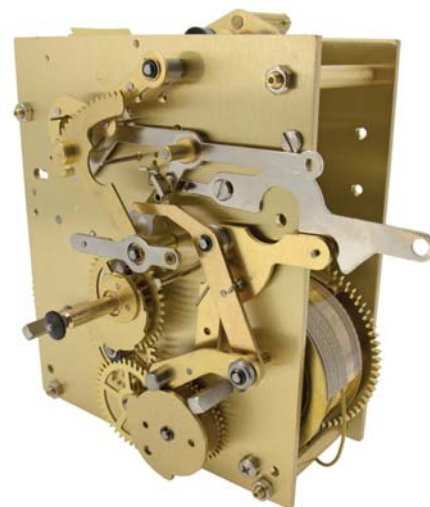

½ Hour bam chime, cable driven clock movement

PS055 stamped on the plate.

Kieninger state that this movement is interchangeable with all PS movements with the same pendulum length & hand shaft length (a different number after the PS denotes an amendment to the movement such as different mounting brackets and does not effect the main features of the movement)

- ½ Hour movement
- Strike: Bam (Coil gong)
- Hammers: 1 at the side
- Plate size: 114 x 99mm
- 4 bronze bushes
- Hand shaft length: 31.80mm (plate to hand nut thread)
- Pendulum length identification is stamped on the movement (pendulums supplied separately)
- Pendulum length in brackets
- Automatic night shut off
- Seconds feature
- Supplied with pendulum leader

See our document download section for Kieninger technical documents

Code	Description	UOM	Price
K47729	Kieninger PS055 (65cm)	EACH	£275.00



**Kieninger SEW01**

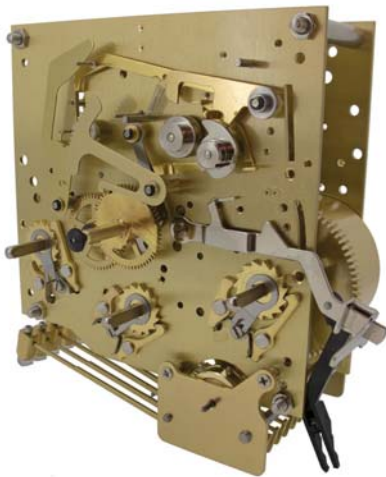

¼ Hour triple chime, key wound clock movement

- ¼ Hour movement
- Strike: Triple chime (Westminster, St. Michael & Whittingdon)
- Hammers: 8 below
- Plate size: 120 x 124mm
- 6 bronze bushes
- 5 Jewel Swiss escapement
- Hand shaft length: 31.80mm (plate to hand nut thread)

See our document download section for Kieninger technical documents

Code	Description	UOM	Price
K47719	Kieninger SEW01	EACH	£235.00

**Kieninger SKS12 (SKS Series)**

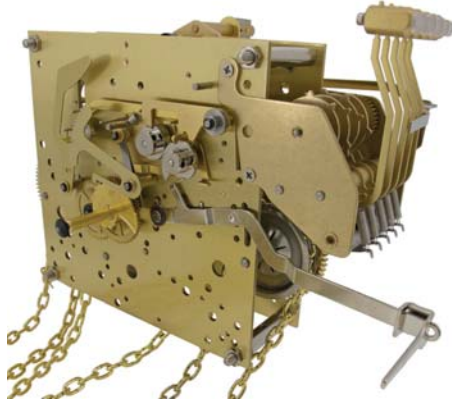

¼ Hour Westminster chime, chain driven movement

SKS12 stamped on the plate.

Kieninger state that this movement is interchangeable with all SKS movements with the same pendulum length & hand shaft length (a different number after the SKS denotes an amendment to the movement such as different mounting brackets and does not effect the main features of the movement)

- ¼ Hour movement
- Strike: Westminster chime
- Hammers: 5 at the side
- Plate size: 120 x 124mm
- 6 bronze bushes
- Hand shaft length: 47.80mm (plate to hand nut thread)
- Pendulum length: 116cm
- Pendulum length in brackets
- Pendulum length identification is stamped on the movement (pendulums supplied separately)
- Supplied with pendulum leader

See our document download section for Kieninger technical documents

Code	Description	UOM	Price
K47722	Kieninger SKS12 (116cm)	EACH	£175.00

**MOVEMENTS (MECHANICAL) VALUE**

**Alarm Mechanism**

**VALUE**



Alarm mechanism for kitchen and mantle clocks

- Assembled
- With hammer, centre pipe & alarm trip
- 45 x 32 x 70mm
- 150g
- Made in India

Code	Description	UOM	Price
M39699	Alarm Mechanism for Kitchen & Mantle Clocks	EACH	£14.95

**Strike & Chime Pendulum Movements**

**VALUE**

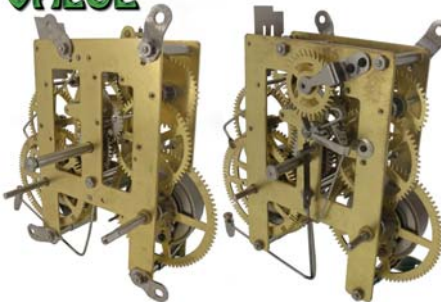

For Kitchen & Mantle Clocks - Made in India

- 8 day, hour & half hour strike movements
- 5½ inch (140mm) or 9½ inch (240mm) pendulum lengths (from centre shaft to tip of pendulum)
- Plate size: 150 x 150 x 45mm
- Hand fitting dimensions: Minute 3.30 x 3.30mm, hour: Ø5.35mm
- Distance from centre arbor to winding shafts 50mm
- Distance between winding shafts 80mm
- Bushed & with oil sinks
- See website "more info" for further specification
- Made in India

Code	Description	UOM	Price
M39698	5½ Inch Pendulum Clock Movement	EACH	£45.00
M39700	9½ Inch Pendulum Clock Movement	EACH	£38.95

**Time Only Pendulum Movements**

**VALUE**



For Kitchen & Mantle Clocks - Made in India

- 8 day movements
- Time only
- Plate size: 120 x 80 x 45mm
- Hand fitting dimensions: Minute 3.30 x 3.30mm, hour: Ø5.35mm
- Supplied with clock key & clock hands
- Designed to be used with the existing pendulum
- Distance from centre arbor to winding shaft 45mm
- For 13 inch (330mm) or 18 inch (460mm) pendulum (not included)
- See website "more info" for further specification
- Made in India

Code	Description	UOM	Price
M39701	13 Inch Pendulum Clock Movement	EACH	£25.95
M39702	18 Inch Pendulum Clock Movement	EACH	£25.95

**MOVEMENTS (MECHANICAL) CUCKOO**

**HUBERT HERR MOVEMENTS & PARTS**



Hubert Herr are one of the only two major cuckoo clock movement manufacturers left in the mystical Black Forest in Germany (the other being Regula) and have been manufacturing mechanical cuckoo movements for decades.

Hubert Herr recommend that replacing a cuckoo clock movement is often quicker and more cost effective than servicing or repairing an old one. Using a new movement ensures you take full advantage of the advances in manufacturing technology



**Pendulum Leaders**

**See Page 1232**

**Hubert Herr KW60 & KW60/1 (1 Day)**



Hubert Herr - 1 Day Movements

- Hubert Herr KW60 & KW60/1
- Original black forest cuckoo clock movements
- Pendulum length in brackets
- Take 275g weights (W1841)
- Made in Germany

Movements supplied with:

- Bird rod assembled
- Chains x 2
- Hooks x 2
- Rings x 2
- Hand nuts

The pendulum length (in brackets) is the measurement from the suspension post (top of the movement) down to the tip of the pendulum leaf.

Code	Description	UOM	Price
M42095	KW60 (24cm) 1 Day Movement	EACH	£59.95
M42096	KW60/1 (28cm) 1 Day Movement	EACH	£59.95

**Hubert Herr KW60/1M (1 Day with Music)**



Hubert Herr - 1 Day Movement - with Music

- Hubert Herr KW60/1M
- Original black forest cuckoo clock movements
- Double door movement with music
- Night shut off
- Pendulum length 28cm
- Takes 275g/320g weights (W1841/W1842)
- Made in Germany

Movements supplied with:

- Bird rod assembled
- Chains x 3
- Hooks x 3
- Rings x 3
- Hand nuts

The pendulum length (in brackets) is the measurement from the suspension post (top of the movement) down to the tip of the pendulum leaf.

Code	Description	UOM	Price
M42097	KW60/1M (28cm) 1 Day with Music	EACH	£64.95

**Hubert Herr KW60/1RM (1 Day with Music & Dancers)**



Hubert Herr - 1 Day Movement - with Music & Dancing Figurines

- Hubert Herr KW60/1RM
- Original black forest cuckoo clock movements
- Double door movement with music
- Night shut off
- Dancing figurines feature (figurines not supplied)
- Platform height: 68mm (from the hand shaft to the revolving platform)
- Pendulum length 28cm
- Takes 275g/320g weights (W1841/W1842)
- Made in Germany

Movements supplied with:

- Bird rod assembled
- Chains x 3
- Hooks x 3
- Rings x 3
- Hand nuts

The pendulum length (in brackets) is the measurement from the suspension post (top of the movement) down to the tip of the pendulum leaf.

Code	Description	UOM	Price
M42098	KW60/1RM (28cm) 1 Day with Music & Dancers	EACH	£79.95

**Hubert Herr KW80 & KW80/1 (8 Day)**



Hubert Herr - 8 Day Movements

- Hubert Herr KW80 & KW80/1
- Original black forest cuckoo clock movements
- Pendulum length in brackets
- Take 1260g weights (W1847)
- Made in Germany

Movements supplied with:

- Bird rod assembled
- Chains x 2
- Hooks x 2
- Rings x 2

- Hand nuts

The pendulum length (in brackets) is the measurement from the suspension post (top of the movement) down to the tip of the pendulum leaf.

Code	Description	UOM	Price
M42099	KW80 (29cm) 8 Day	EACH	£67.95
M42100	KW80/1 (38cm) 8 Day	EACH	£72.95

**Hubert Herr KW80/1M (8 Day with Music)**



Hubert Herr - 8 Day Movement - with Music

- Hubert Herr KW80/1M
- Original black forest cuckoo clock movements
- Double door movement with music
- Night shut off
- Pendulum length 38cm
- Takes 1260g/1500g weights (W1847/W1848)
- Made in Germany

Movements supplied with:

- Bird rod assembled
- Chains x 3
- Hooks x 3
- Rings x 3
- Hand nuts

The pendulum length (in brackets) is the measurement from the suspension post (top of the movement) down to the tip of the pendulum leaf.

Code	Description	UOM	Price
M42101	KW80/1M (38cm) 8 Day with Music	EACH	£99.95

**Leg Clamps**



Ref: C6477  
See Page: 929

**Hubert Herr KW80/1RM (8 Day with Music & Dancers)**



Hubert Herr - 8 Day Movement - with Music & Dancing Figurines

- Hubert Herr KW80/1RM
- Original black forest cuckoo clock movements
- Double door movement with music
- Night shut off
- Dancing figurines feature (figurines not supplied)
- Platform height: 80mm (from the hand shaft to the revolving platform)
- Pendulum length 38cm
- Takes 1260g/1500g weights (W1847/W1848)
- Made in Germany

Movements supplied with:

- Bird rod assembled
- Chains x 3
- Hooks x 3
- Rings x 3
- Hand nuts

The pendulum length (in brackets) is the measurement from the suspension post (top of the movement) down to the tip of the pendulum leaf.

Code	Description	UOM	Price
M42102	KW80/1RM (38cm) 8 Day with Music & Dancers	EACH	£111.95

**1 Day Movement Parts**



Hubert Herr Movement Parts - KW60 Series

- Chain wheels
- Hand nuts
- Pallet forks
- Suspension hangers

Code	Description	UOM	Price
H43001	Chain Wheel Strike Side (KW60)	EACH	£8.50
H42999	Chain Wheel Time Side (KW60)	EACH	£7.95
H43003	Chain Wheel (KW60 with Music)	EACH	£8.95
H43005	Driving Wheel (KW60 with Music)	EACH	£4.50
H43009	Hand Nuts (KW60)	PACK*3	£1.95
H43007	Pallet Fork (KW60)	EACH	£4.50
H43011	Suspension Hanger (KW60)	EACH	£5.50

**8 Day Movement Parts**



Hubert Herr Movement Parts - KW80 Series

- Chain wheels
- Hand nuts
- Pallet forks
- Suspension hangers

Code	Description	UOM	Price
H43002	Chain Wheel Strike Side (KW80)	EACH	£9.95
H43000	Chain Wheel Time Side (KW80)	EACH	£9.95
H43004	Chain Wheel (KW80 with Music)	EACH	£8.95
H43006	Driving Wheel (KW80 with Music)	EACH	£4.50
H43010	Hand Nuts (KW80)	PACK*2	£1.95
H43008	Pallet Fork (KW80)	EACH	£5.95
H43012	Suspension Hanger (KW80)	EACH	£5.95

**REGULA MOVEMENTS & PARTS**



Regula are one of the only two major cuckoo clock movement manufacturers left in the mystical Black Forest in Germany (the other being Hubert Herr) and have been manufacturing mechanical cuckoo movements for decades.

Regula recommend that replacing a cuckoo clock movement is often quicker and more cost effective than servicing or repairing an old one. Using a new movement ensures you take full advantage of the advances in manufacturing technology

Part sheets are available in our document download section. If you require a part please submit your request via our online support system, under "products & stock - New item requests (excluding watch and clock parts by brand & movements)". The clockwork model number, the year of manufacture and the pendulum length are all required to order spare parts. All these details can be found on the movement plates



**Regula 25 (1 Day)**

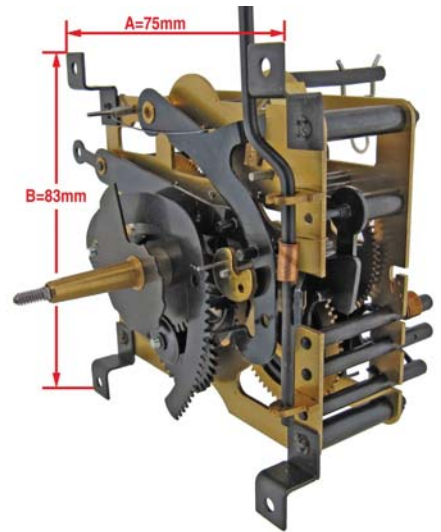

Regula 25 - 1 Day Cuckoo Clock Movement

- Cuckoo call and gong on the half hour and hour
- Plate size: 68 x 73mm
- Width between plates: 20mm
- Pendulum length in brackets (pendulum length stamped on the movement)\*
- A number or letter next to the calibre denotes the year of manufacture
- Supplied with chains, hooks and rings

Additionally:

- For individual pairs of hands see references H4886 to H4893 inclusive.
- For sets of hands see references H32156 & H32157
- Made in Germany

The pendulum length is the measurement from the suspension post (top of the movement) down to the centre of the pendulum leaf.

\*The pendulum length (in brackets) is stamped on the movement. If there is no pendulum length stamped on the movement, then the pendulum length will be 19.1cm

Code	Description	UOM	Price
M7871	Regula 25 (19.1cm) 1 Day	EACH	£44.95
M42104	Regula 25 (23.5cm) 1 Day	EACH	£44.95
M42105	Regula 25 (28.5cm) 1 Day	EACH	£44.95

**Regula 25 (1 Day with Dancers)**



Regula 25 - 1 Day Cuckoo Clock Movement - with Dancers

- Cuckoo call and gong on the half hour and hour
- Plate size: 79.5 x 73mm
- Width between plates: 20mm
- Pendulum length in brackets (pendulum length stamped on the movement)\*
- A number or letter next to the calibre denotes the year of manufacture

- Supplied with chains, hooks and rings
- Plate for dancing figures (supplied separately)
- Plate height 24 or 41mm (measured from the top of the pendulum to the plate)

Additionally:

- For individual pairs of hands see references H4886 to H4893 inclusive.
- For sets of hands see references H32156 & H32157
- Made in Germany

The pendulum length (in brackets) is the measurement from the suspension post (top of the movement) down to the centre of the pendulum leaf.

\*The pendulum length is stamped on the movement. If there is no pendulum length stamped on the movement, then the pendulum length will be 19.1cm

Code	Description	UOM	Price
M42106	Regula 25 with Dancers (19.1cm), Plate Height 24mm	EACH	£74.95
M42107	Regula 25 with Dancers (19.1cm), Plate Height 41mm	EACH	£74.95
M42108	Regula 25 with Dancers (23.5cm), Plate Height 24mm	EACH	£74.95
M42109	Regula 25 with Dancers (23.5cm), Plate Height 41mm	EACH	£74.95

### Regula 34 (8 Day)



Regula 34 - 8 Day Cuckoo Clock Movement

- Cuckoo call and gong on the half hour and hour
- Plate size: 78 x 85mm
- Width between plates: 20mm
- Pendulum length in brackets (pendulum length stamped on the movement)\*
- A number or letter next to the calibre denotes the year of manufacture
- Supplied with chains, hooks and rings

Additionally:

- For individual pairs of hands see references H4886 to H4893 inclusive.
- For sets of hands see references H32156 & H32157
- Made in Germany

The pendulum length (in brackets) is the measurement from the suspension post (top of the movement) down to the centre of the pendulum leaf.

\*The pendulum length is stamped on the movement. If there is no pendulum length stamped on the movement, then the pendulum length will be 19.1cm

Code	Description	UOM	Price
M42110	Regula 34 (19.1cm) 8 Day	EACH	£69.95
M7872	Regula 34 (23.5cm) 8 Day	EACH	£69.95
M42111	Regula 34 (28.5cm) 8 Day	EACH	£69.95

### Regula 34 (8 Day with Dancers)



Regula 34 - 8 Day Cuckoo Clock Movement - with Dancers

- Cuckoo call and gong on the half hour and hour
- Plate size: 78 x 85mm
- Width between plates: 20mm
- Pendulum length in brackets (pendulum length stamped on the movement)
- A number or letter next to the calibre denotes the year of manufacture
- Supplied with chains, hooks and rings
- Plate for dancing figures (supplied separately)
- Plate height 81mm (measured from hand shaft to the plate)

Additionally:

- For individual pairs of hands see references H4886 to H4893 inclusive.
- For sets of hands see references H32156 & H32157
- Made in Germany

The pendulum length (in brackets) is the measurement from the suspension post (top of the movement) down to the centre of the pendulum leaf.

Code	Description	UOM	Price
M42112	Regula 34 with Dancers (23.5cm)	EACH	£89.95
M42113	Regula 34 with Dancers (28.5cm)	EACH	£89.95

### Regula 34 (8 Day with Dancers & Brass Band)



Regula 34 - 8 Day Cuckoo Clock Movement - with Dancers & Brass Band

- Cuckoo call and gong on the half hour and hour

- Plate size: 78 x 85mm
- Width between plates: 20mm
- Pendulum length in brackets (pendulum length stamped on the movement)
- A number or letter next to the calibre denotes the year of manufacture
- Supplied with chains, hooks and rings
- Plate for dancing figures & brass band (supplied separately)
- Plate height 81mm (measured from hand shaft to the plate)

Additionally:

- For individual pairs of hands see references H4886 to H4893 inclusive.
- For sets of hands see references H32156 & H32157
- Made in Germany

The pendulum length is the measurement from the suspension post (top of the movement) down to the centre of the pendulum leaf.

Code	Description	UOM	Price
M42114	Regula 34 with Dancers & Brass Band (23.5cm)	EACH	£94.95

### Regula 71 (1 Day Cuckoo & Quail)

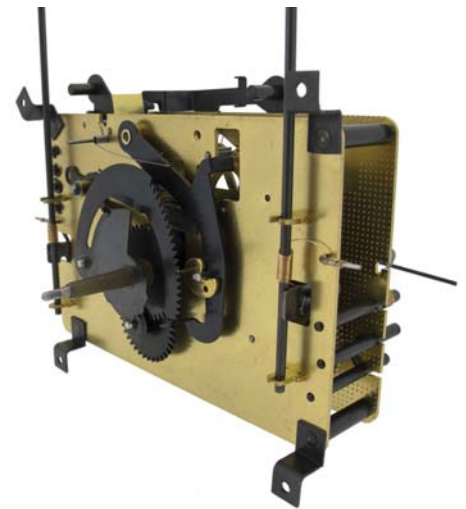

Regula 71 - 1 Day Cuckoo Clock Movement - Cuckoo & Quail

- Cuckoo call and gong on the half hour and hour
- Quail call every quarter hour
- Plate size: 77 x 116mm
- Width between plates: 20mm
- Pendulum length in brackets (pendulum length stamped on the movement)
- A number or letter next to the calibre denotes the year of manufacture
- Supplied with chains, hooks and rings

Additionally:

- For individual pairs of hands see references H4886 to H4893 inclusive.
- For sets of hands see references H32156 & H32157
- Made in Germany

The pendulum length is the measurement from the suspension post (top of the movement) down to the centre of the pendulum leaf.

Code	Description	UOM	Price
M42115	Regula 71 (28.5cm)	EACH	£119.95

#### Pendulum Leaders

See Page 1232

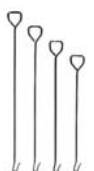

**Regula 72 (8 Day)**



Regula 72 - 8 Day Cuckoo Clock Movement

- Cuckoo call and gong on the half hour and hour
- Plate size: 77 x 116mm
- Width between plates: 20mm
- Pendulum length in brackets (pendulum length stamped on the movement)
- A number or letter next to the calibre denotes the year of manufacture
- Supplied with chains, hooks and rings
- 2 bird posts

Additionally:

- For individual pairs of hands see references H4886 to H4893 inclusive.
- For sets of hands see references H32156 & H32157
- Made in Germany

The pendulum length is the measurement from the suspension post (top of the movement) down to the centre of the pendulum leaf.

Code	Description	UOM	Price
M42116	Regula 72 (28.5cm)	EACH	£126.95
M42117	Regula 72 (40cm)	EACH	£126.95

**Regula 72 (8 Day with Dancers, No Music)**



Regula 72 - 8 Day Cuckoo Clock Movement

- Cuckoo call and gong on the half hour and hour
- Plate size: 77 x 116mm
- Width between plates: 20mm
- Pendulum length in brackets (pendulum length stamped on the movement)

- A number or letter next to the calibre denotes the year of manufacture
- Supplied with chains, hooks and rings
- Plate for dancing figures (supplied separately)
- Plate height (PH) 81 or 152mm (measured from hand shaft to the plate)

Additionally:

- For individual pairs of hands see references H4886 to H4893 inclusive.
- For sets of hands see references H32156 & H32157
- Made in Germany

The pendulum length is the measurement from the suspension post (top of the movement) down to the centre of the pendulum leaf.

Code	Description	UOM	Price
M42118	Regula 72 (28.5cm), PH 81mm	EACH	£115.95
M42119	Regula 72 (40cm), PH 152mm	EACH	£115.95

**Regula 72 (8 Day with Dancers & Music)**



Regula 72 - 8 Day Cuckoo Clock Movement

- Cuckoo call and gong on the half hour and hour
- Plate size: 77 x 116mm
- Width between plates: 20mm
- Pendulum length in brackets (pendulum length stamped on the movement)
- A number or letter next to the calibre denotes the year of manufacture
- Supplied with chains, hooks and rings
- Plate for dancing figures (supplied separately)
- Plate height 152mm (measured from hand shaft to the plate)
- With music functionality (as the figures move, the music box already existing within the movement is triggered).

Additionally:

- For individual pairs of hands see references H4886 to H4893 inclusive.
- For sets of hands see references H32156 & H32157
- Made in Germany

The pendulum length is the measurement from the suspension post (top of the movement) down to the centre of the pendulum leaf.

Code	Description	UOM	Price
M42120	Regula 72 (40cm)	EACH	£164.95



**Chain Wheels, Strike Side**

Regula Strike Side Chain Wheels



- Regula 25, all pendulum lengths = (1)
- Regula 25 with dancers, all pendulum lengths = (1)
- Regula 34, all pendulum lengths = (2)
- Regula 34 with dancers, all pendulum lengths = (2)
- Regula 34 with dancers & brass band, all pendulum lengths = (2)
- Regula 71, all pendulum lengths = (3)
- Regula 72, all pendulum lengths = (4)
- Regula 72 with dancers no music, all pendulum lengths = (4)
- Regula 72 with dancers & with music, all pendulum lengths = (4)

Code	Description	UOM	Price
R48352	(1) 25.10.104.000.00 Chain Wheel, Strike Side	EACH	£6.95
R48657	(2) 34.10.011.000.00 Chain Wheel, Strike Side	EACH	£6.95
R48354	(3) 35.10.104.000.00 Chain Wheel, Strike Side	EACH	£6.95
R48658	(4) 72.10.011.000.00 Chain Wheel, Strike Side	EACH	£6.95

**Chain Wheels, Time Side**

Regula Time Side Chain Wheels



- Regula 25, pendulum length 19.1cm = (1)
- Regula 25, pendulum length 23.5cm = (2)
- Regula 25, pendulum length 28.5cm = (3)
- Regula 25 with dancers, pendulum length 19.1cm = (1)
- Regula 25 with dancers, pendulum length 23.5cm = (2)
- Regula 25 with dancers, pendulum length 28.5cm = (3)
- Regula 34, all pendulum lengths = (4)
- Regula 34 with dancers, all pendulum lengths = (5)
- Regula 34 with dancers & brass band, all pendulum lengths = (5)
- Regula 71, pendulum length 28.5cm = (6)
- Regula 72, all pendulum lengths = (7)
- Regula 72 with dancers no music, all pendulum lengths = (7)
- Regula 72 with dancers & with music, all pendulum lengths = (7)

Code	Description	UOM	Price
R48343	(1) 25.10.102.000.19.1 Chain Wheel, Time Side	EACH	£6.95
R48344	(2) 25.10.102.000.23.5 Chain Wheel, Time Side	EACH	£6.95
R48345	(3) 25.10.102.000.28.5 Chain Wheel, Time Side	EACH	£6.95
R48659	(4) 34.10.010.000.00 Chain Wheel, Time Side	EACH	£6.95
R48660	(5) 34.10.010.044.00 Chain Wheel, Time Side	EACH	£6.95
R48351	(6) 70.10.102.000.00, Chain Wheel, Time Side	EACH	£6.95
R48661	(7) 72.10.010.000.00 Chain Wheel, Time Side	EACH	£6.95

**Chain Wheel Gears, Time Side**



Regula Time Side Chain Wheel Gears

- Regula 34, pendulum length 19.1cm = (1)

- Regula 34, pendulum length 23.5cm = (2)
- Regula 34, pendulum length 28.5cm = (3)
- Regula 34 with dancers, pendulum length 23.5cm = (4)
- Regula 34 with dancers, pendulum length 28.5cm = (5)
- Regula 34 with dancers & brass band, pendulum length 23.5cm = (4)
- Regula 34 with dancers & brass band, pendulum length 28.5cm = (5)
- Regula 72, all pendulum lengths = (6)
- Regula 72 with dancers no music, all pendulum lengths = (6)
- Regula 72 with dancers & with music, all pendulum lengths = (6)

Code	Description	UOM	Price
R48346	(1) 34.10.020.000.19.1, Chain Wheel Gear	EACH	£6.95
R48353	(2) 34.10.020.000.23.5, Chain Wheel Gear	EACH	£6.95
R48348	(3) 34.10.020.000.28.5, Chain Wheel Gear	EACH	£6.95
R48349	(4) 34.10.020.044.23.5, Chain Wheel Gear	EACH	£6.95
R48350	(5) 34.10.020.044.28.5, Chain Wheel Gear	EACH	£6.95
R48355	(6) 72.10.024.000.00, Chain Wheel Gear	EACH	£6.95

**Figurine Drive System Parts**

- Movement parts for the figurine drive systems
- Regula movement parts
- Regula part sheet number in brackets



Part sheets are available in our document download section.

Code	Description	UOM	Price
M48067	Regula 34 Figurine Drive System (39) Wheel	EACH	£5.95

**MOVEMENTS, MAINS SYNCHRONOUS**

**Mains Synchronous**

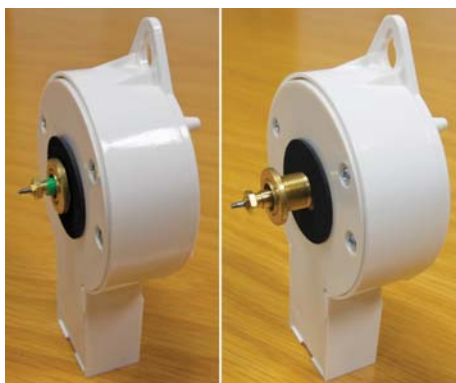

Synchronous Mains Clock Movements - Regular

- Regular Version
- 230/240v 50Hz Self Starting
- Integral Hanger, Back Setting Knob
- Fittings included
- No direct replacement centre seconds hand available
- CE certified

Specification:  
 • 15mm Shaft (Maximum dial thickness 4mm) -  
 • 23mm Shaft (Maximum dial thickness 11mm)

- Hour wheel collet: Ø5.00mm (approx)
- Minute Wheel collet: 3.50 x 2.80mm (approx)
- Centre seconds thread: Ø1.40mm

Dimensions:  
 • Head diameter Ø65mm  
 • Head thickness 25mm  
 • Base 25 x 35 x 20mm

N.B. If replacement hands are required, Euroshaft hour & minute hands are the closest fit & may need adapting.

Code	Description	UOM	Price
M7813	15mm Shaft Movement	EACH	£34.95
M7814	23mm Shaft Movement	EACH	£34.95

Price breaks available, see website

**Mains Synchronous, Hi Torque**

Synchronous Mains Clock Movements - Hi Torque



- Hi Torque Version
- Will carry heavier type counter balanced hands
- 230/240v 50Hz Self Starting
- Integral Hanger, Side Setting
- Fittings included (excludes adjusting shaft)
- Hour & Minute (Non seconds)
- Includes special minute & hour collets for adapting original hands or new hands
- CE certified

Hand Fitting dimensions:  
 • Hour Shaft: Ø6.40mm  
 • Minute Shaft: Ø4.50mm  
 • Additional hour shaft collet: Ø8.00mm (Included but also available separately)  
 • Additional minute shaft collet: Ø6.00mm (Included but also available separately)  
 • Please be aware there are no direct replacement hands available for these movements

Dimensions:  
 • Head diameter Ø65mm  
 • Head thickness 25mm  
 • Base 25 x 35 x 20mm

Specification:  
 • 35mm Shaft (Maximum dial thickness 20mm)

Code	Description	UOM	Price
M7815	35mm Shaft Movement, Hi Torque	EACH	£49.95
M46178	Ø6.00mm Collet	EACH	£2.95
M46179	Ø8.00mm Collet	EACH	£2.95
M46254	Grub Screw for Collet	EACH	£1.25

Price breaks available, see website

**Mains Synchronous, Adjusting Shaft**



Synchronous Mains Clock Movement Adjusting Shaft - Hi Torque

- Brass
- Overall length 150mm
- Knurled plastic knob

For use with synchronous mains movement M7815

Code	Description	UOM	Price
M7816	Adjusting Shaft	EACH	£7.50

Price breaks available, see website

**MOVEMENTS, MUSICAL BOX**

**Musical Box Movements**



Musical Movements

- Swiss Made
- High Quality
- Single Melody
- 18 Tooth Combs
- Size: 52 x 44 x 21mm

- Tunes:
- Ave Maria
  - Edelweiss
  - Eine Kleine
  - Glockenspiel
  - Lullaby
  - Memory
  - My lady Greensleeves
  - Phantom of the Opera
  - Romeo & Juliet
  - Serenade
  - Silent Night
  - Swan Lake

Code	Description	UOM	Price
M7614	Ave Maria (Gounod) Movement	EACH	£46.95
M12358	Edelweiss (Rodgers) Movement	EACH	£46.95
M0988	Eine Kleine (Allergro) Movement	EACH	£46.95
M12353	Glockenspiel (Mozart) Movement	EACH	£46.95
M0989	Lullaby (Brahms) Movement	EACH	£46.95
M12357	Memory (Webber) Movement	EACH	£46.95
M0986	My Lady Greensleeves Movement	EACH	£46.95
M12359	Phantom of the Opera Movement	EACH	£46.95
M0987	Romeo & Juliet Movement	EACH	£46.95
M12354	Serenade (Haydn) Movement	EACH	£46.95
M12356	Silent Night (Gruber) Movement	EACH	£46.95
M12355	Swan Lake (Tchaikovsky) Movement	EACH	£46.95



# MOVEMENTS, QUARTZ

The largest collection of quartz clock movements in the world.

- UTS, Seiko, Hermle & Swiza
- Spindle lengths are measured from the movement to the tip of the shaft.
- Euro Fitting ("EF" or "I shaft") or Non Euro Fitting ("NEF" or "Push fit") versions available

Types:

- 24 Hour Dial Clock
- Alarm
- Carriage Clock
- Carriage Clock with Alarm
- Continuous sweep seconds
- Hi Torque
- Pendulum (including radio controlled versions)
- Radio Controlled (including hi torque versions)
- Reverse Time Keeping
- Standard
- Strike & Chime (including pendulum versions)

## 24 Hour Dial, UTS



Clock Movement - To be used in conjunction with a 24 Hour Dial

- 24 Hour Quartz UTS Movement
- For use with a 24 hour dial
- Euro Fitting (EF) or Non Euro Fitting (NEF) hand shafts
- Hi Torque (8mm shaft not high torque)
- Uses LR6 battery
- Complete with Fittings
- Can take minute hands up to 400mm long, weighing up to 20 grams
- Can take centre seconds hands up to 125mm long, weighing up to 1.2 grams

Dimensions:

- 57 x 57 x 17mm
- Shaft = From movement front to shaft tip

Euro Fitting (EF) Hand Collet Dimensions:

- Minute: 3.5 x 2.8mm
- Hour: Ø5.00mm

Non Euro Fitting (NEF) Hand Collet Dimensions:

- Minute: Ø3.50mm
- Hour: Ø5.00mm

Code	Description	UOM	Price
J46230	8mm (NEF) Shaft 24 Hour Movement	EACH	£2.85
J37161	16mm (EF) Shaft 24 Hour Movement	EACH	£2.85
J46231	16mm (NEF) Shaft 24 Hour Movement	EACH	£2.85

Price breaks available, see website

## Carriage Clock, Round, UTS

Clock Movement - Carriage Clock - Round

- Mini Quartz UTS Movement
- Non-Alarm
- Uses LR1 Battery
- Non Euro shaft
- See hands H35344, H35345, H35347, H35346

Non Euro Fitting (NEF) Hand Collet Dimensions:

- Minute: Ø1.95mm
- Hour: Ø3.35mm

Dimensions:

- Ø51mm x 17 mm
- Shaft = From movement front to shaft tip

Code	Description	UOM	Price
J45742	7.1mm (NEF) Carriage Clock Movement	EACH	£4.45
J3132M	9.8mm (NEF) Carriage Clock Movement	EACH	£4.45

Price breaks available, see website



## Carriage Clock, Round with Alarm, UTS

Clock Movement - Carriage Clock - Alarm

- Mini Quartz Alarm UTS Movement
- Uses LR1 Battery
- Non Euroshaft fitting
- See hands H35344, H35345, H35347, H35346

Non Euro Fitting (NEF) Hand Collet Dimensions:

- Minute: Ø1.95mm
- Hour: Ø3.35mm
- Alarm: Ø4.00mm

Dimensions:

- Ø53mm x 17mm
- Shaft = From movement front to shaft tip

Code	Description	UOM	Price
J45743	7mm (NEF) Alarm Carriage Clock	EACH	£5.95
J3134M	9.8mm (NEF) Alarm Carriage Clock	EACH	£5.95
J45744	9.8mm (NEF) Alarm Carriage Clock with Flush Knob	EACH	£5.95

Price breaks available, see website



## Carriage Clock, Square, UTS

Clock Movement - Carriage Clock - Square

- Carriage Clock Quartz UTS Movement
- Non Euroshaft Version
- LR6 Battery
- Push fit hands for carriage clock application
- Centre fixing nut
- See hands H35344, H35345, H35347, H35346

Non Euro Fitting (NEF) Hand Collet Dimensions:

- Minute: Ø1.95mm
- Hour: Ø3.35mm

Dimensions:

- 57 x 57 x 17mm
- Shaft = From movement front to shaft tip
- Shaft length: 4.50mm

Code	Description	UOM	Price
J6031	4.5mm (NEF) Shaft Mini (Carriage Clock) Movement	EACH	£2.70

Price breaks available, see website



## Carriage Clock, Square with Alarm, Seiko

Clock Movement - Carriage Clock - Square with Alarm

- Carriage clock with alarm Seiko quartz movement
- Beep or bell type alarm
- Non Euro Fitting (NEF) hand shafts
- Uses LR6 battery
- Complete with Fittings
- Can take minute hands up to 45mm long, weighing up to 2 grams
- Can take centre seconds hands up to 45mm long, weighing up to 1 gram
- See website "more info" for specifications

Dimensions:

- 57 x 50 x 16mm
- Shaft = From movement front to shaft tip

Non Euro Fitting (NEF) Hand Collet Dimensions:

- Minute: Ø1.90mm
- Hour: Ø3.09mm
- Alarm: Ø4.26mm
- Please be aware currently there are no direct replacement hands available for these movements

Code	Description	UOM	Price
J47752	Beep Alarm, 6.2mm (NEF) Shaft Movement	EACH	£5.65
J47753	Beep Alarm, 8.8mm (NEF) Shaft Movement	EACH	£6.45
J47754	Bell Alarm, 8.8mm (NEF) Shaft Movement	EACH	£6.45

Price breaks available, see website



## Continuous Sweep Seconds, Seiko

Clock Movement - Sweep Seconds - Seiko - Non Euro Fitting (NEF)

- Sweep Seconds Quartz Seiko Movement
- For Seiko calibres check see website "more info"
- Uses LR6 battery
- Complete with fittings
- Takes all Non Euro shaft hands

Non Euro Fitting (NEF) Hand Collet Dimensions:

- Minute: Ø3.50mm
- Hour: Ø5.50mm

Dimensions:

- 57 x 57 x 17mm
- Shaft = From movement front to shaft tip

\* Non centre nut fixing model (secure with double sided tape)

Code	Description	UOM	Price
J47167	*8mm (NEF) Shaft Movement	EACH	£6.60
J47168	11.4mm (NEF) Shaft Movement	EACH	£4.60
J39112	15.4mm (NEF) Shaft Movement	EACH	£4.60

Price breaks available, see website



## Continuous Sweep Seconds, Seiko Hi Torque

Clock Movement - Sweep Seconds - Seiko - Euro Fitting (EF)

- Sweep Seconds Quartz Seiko Movement
- High torque
- For longer or heavier counter balanced hands
- Can take minute hands up to 400mm long, weighing up to 22 grams





- Can take centre seconds hands up to 125mm long, weighing up to 1.2 grams
- Uses LR6 battery
- Complete with fittings
- Euro fitting hand shaft (EF)

Euro Fitting (EF) Hand Collet Dimensions:  
 • Minute: 3.5 x 2.8mm  
 • Hour: Ø5.00mm

Dimensions:  
 • 57 x 57 x 17mm  
 • Shaft = From movement front to shaft tip

Code	Description	UOM	Price
J47179	16.5mm (EF) Shaft Movement	EACH	£7.75
Price breaks available, see website			

### Hi Torque, Seiko

High Torque - Seiko

- Uses LR6 Battery
- For Seiko calibres check see website "more info"
- Euro Fitting (EF) or Non Euro Fitting (NEF) hand shafts
- For longer or heavier counter balanced hands
- Can take minute hands up to 400mm long, weighing up to 22 grams
- Can take centre seconds hands up to 125mm long, weighing up to 1.2 grams



Dimensions:  
 • 57 x 57 x 17mm  
 • Shaft = From movement front to shaft tip

Euro Fitting (EF) Hand Collet Dimensions:  
 • Minute: 3.5 x 2.8mm  
 • Hour: Ø5.00mm

Non Euro Fitting (NEF) Hand Collet Dimensions:  
 • Minute: Ø3.50mm  
 • Hour: Ø5.50mm

Code	Description	UOM	Price
J47178	13.2mm (NEF) Shaft Movement	EACH	£4.35
J47177	16.5mm (EF) Shaft Movement	EACH	£4.95
Price breaks available, see website			

### Hi Torque, UTS

Clock Movement - Hi Torque - Euro Fitting (EF)

- High Torque Quartz UTS Movement
- Uses LR6 Battery
- For longer or heavier Counter balanced hands
- Takes all Euro shaft hands
- Can take minute hands up to 400mm long, weighing up to 22 grams
- Can take centre seconds hands up to 125mm long, weighing up to 1.2 grams



Dimensions:  
 • 57 x 57 x 17mm  
 • Shaft = From movement front to shaft tip

Euro Fitting (EF) Hand Collet Dimensions:  
 • Minute: 3.5 x 2.8mm  
 • Hour: Ø5.00mm

Code	Description	UOM	Price
J40129	11mm (EF) Shaft Movement, Hi Torque	EACH	£2.70
J3137M	16mm (EF) Shaft Movement, Hi Torque	EACH	£2.70
J40130	21mm (EF) Shaft Movement, Hi Torque	EACH	£2.70
Price breaks available, see website			

### Pendulum, Seiko

Clock Movement - Pendulum - Seiko

- Pendulum Quartz Seiko Movement
- For Seiko calibres check see website "more info"
- Euro Fitting (EF) or Non Euro Fitting (NEF) hand shafts
- Uses LR14 Battery
- Allowed Pendulum Length 120 to 350mm
- Allowed Pendulum Weight 15 to 55g



Dimensions:  
 • 81 x 58 x 22mm  
 • Shaft = From movement front to shaft tip

Euro Fitting (EF) Hand Collet Dimensions:  
 • Minute: 3.5 x 2.8mm  
 • Hour: Ø5.00mm

Non Euro Fitting (NEF) Hand Collet Dimensions:  
 • Minute: Ø3.50mm  
 • Hour: Ø5.50mm

Code	Description	UOM	Price
J47176	11.4mm (NEF) Shaft Movement	EACH	£6.60
J39113	16.5mm (EF) Shaft Movement	EACH	£6.95
J47175	16.5mm (NEF) Shaft Movement	EACH	£6.60
J47174	26.5mm (EF) Shaft Movement	EACH	£7.50
Price breaks available, see website			

### Pendulum, UTS

Clock Movement - Pendulum

- Pendulum Quartz UTS Movement
- Euroshaft
- Uses LR6 Battery
- Takes all Euroshaft hands
- Can take pendulum length up to 500mm, max pendulum weight 80g
- Pendulum & Rod = J3129
- Can take minute hands up to 160mm long, weighing up to 8 grams
- Can take centre seconds hands up to 90mm long, weighing up to 0.6 grams



Dimensions:  
 • 56mm x 108mm  
 • Shaft = From movement front to shaft tip

Euro Fitting (EF) Hand Collet Dimensions:  
 • Minute: 3.5 x 2.8mm  
 • Hour: Ø5.00mm

Code	Description	UOM	Price
J312811	11mm (EF) Pendulum Movement	EACH	£4.75
J312816	16mm (EF) Pendulum Movement	EACH	£4.75
J312821	21mm (EF) Pendulum Movement	EACH	£4.75
J312826	26mm (EF) Pendulum Movement	EACH	£4.75
Price breaks available, see website			

**PRICE PROMISE GUARANTEE**

### Clock Batteries

See Page 8



### Pendulum Drive Unit



Pendulum Drive Unit - Quartz

- Turn any standard quartz movement into a pendulum movement
- Fits quartz movements that are 57 x 57 x 17mm
- 130 x 60mm (length x width)
- Maximum pendulum length 600mm
- Made in Taiwan

Code	Description	UOM	Price
P48839	Pendulum Drive Unit	EACH	£3.25
Price breaks available, see website			

### Radio Controlled, UTS

Clock Movement - Radio Controlled - UTS

Fully automatic with high speed time setting - "Insert the battery and everything else is quick and fully automatic"



- UTS
- Integrated antenna
- Battery: MN1500 (LR6)
- Time change (summer / winter) fully automatic
- Automatic synchronisation
- Non Euro fitting hands
- Can take minute hands up to 160mm long, weighing up to 2.5 grams
- Can take centre seconds hands up to 130mm long, weighing up to 1 gram
- Fittings supplied
- Signal originates from Germany (see additional image for coverage area)
- When assembling set hands at 11 o'clock

Dimensions:  
 • 55 x 55 x 20mm  
 • Shaft = From movement front to shaft tip

Non Euro Fitting (NEF) Hand Collet Dimensions:  
 • Minute: Ø3.50mm  
 • Hour: Ø5.00mm

- Possible causes of interference:
- Domestic appliances
  - TV receivers closer than 2 metres
  - Machinery with HF leakage
  - Signal may be affected by mountainous or hilly terrain or adverse meteorological conditions

- Troubleshooting:
- Check correct polarity of battery
  - Ensure the clock is at least 6 feet away from a TV, computer, air conditioner or any other electrical household appliances. Optimal location is near a window
  - Remove battery and start again
  - There may be an interruption at the transmitter. Wait a few hours and try again

• Due to the signal requirements of these movements it is important that a fresh, fully charged alkaline battery is used initially and then changed on a regular basis as a partially charged battery may not be strong enough to receive the radio signal, resulting in the movement not fully functioning correctly

Code	Description	UOM	Price
J40227	11mm (NEF) Shaft Movement, Radio Controlled	EACH	£9.95
J40228	18mm (NEF) Shaft Movement, Radio Controlled	EACH	£9.95

Price breaks available, see website

## Radio Controlled & Hi Torque, UTS

Clock Movement - Radio Controlled - UTS - Hi Torque

Fully automatic with high speed time setting - "Insert the battery and everything else is quick and fully automatic"

- UTS
- Integrated antenna
- Super hi torque
- Battery: MN1500 (LR6)
- Time change (summer / winter) fully automatic
- Automatic synchronisation
- Non Euro fitting hands
- Can take minute hands up to 230mm long, weighing up to 30 grams
- Can take centre seconds hands up to 200mm long, weighing up to 2 grams
- Fittings supplied
- Signal originates from Germany (see additional image for coverage area)
- When assembling set hands at 11 o'clock

Dimensions:  
 • 90 x 65 x 25mm  
 • Shaft = From movement front to shaft tip

Non Euro Fitting (NEF) Hand Collet Dimensions:  
 • Minute: Ø3.50mm  
 • Hour: Ø5.00mm

Possible causes of interference:  
 • Domestic appliances  
 • TV receivers closer than 2 metres  
 • Machinery with HF leakage  
 • Signal may be affected by mountainous or hilly terrain or adverse meteorological conditions

Troubleshooting:  
 • Check correct polarity of battery  
 • Ensure the clock is at least 6 feet away from a TV, computer, air conditioner or any other electrical household appliances. Optimal location is near a window  
 • Remove battery and start again  
 • There may be an interruption at the transmitter. Wait a few hours and try again  
 • Due to the signal requirements of these movements it is important that a fresh, fully charged alkaline battery is used initially and then changed on a regular basis as a partially charged battery may not be strong enough to receive the radio signal, resulting in the movement not fully functioning correctly

Code	Description	UOM	Price
J40131	11mm (NEF) Shaft Movement, Radio Controlled	EACH	£15.95
J40132	18mm (NEF) Shaft Movement, Radio Controlled	EACH	£15.95

Price breaks available, see website

**Clock Restoration  
(Case, Dial etc)**

**See Page 1169**



## Radio Controlled with Pendulum, UTS

Clock Movement - Pendulum - Radio Controlled

- Pendulum Quartz UTS Movement
- Radio controlled
- Euroshaft
- Battery: MN1500 (LR6)
- Non Euro fitting hands
- Can take minute hands up to 120mm long, weighing up to 1 gram
- Can take centre seconds hands up to 90mm long, weighing up to 1 gram
- Pendulum & Rod = J3129
- Signal originates from Germany (see additional image for coverage area)
- When assembling set hands at 11 o'clock

Dimensions:  
 • 75mm x 108mm  
 • Shaft = From movement front to shaft tip

Non Euro Fitting (NEF) Hand Collet Dimensions:  
 • Minute: Ø3.50mm  
 • Hour: Ø5.00mm

Possible causes of interference:  
 • Domestic appliances  
 • TV receivers closer than 2 metres  
 • Machinery with HF leakage  
 • Signal may be affected by mountainous or hilly terrain or adverse meteorological conditions

Troubleshooting:  
 • Check correct polarity of battery  
 • Ensure the clock is at least 6 feet away from a TV, computer, air conditioner or any other electrical household appliances. Optimal location is near a window  
 • Remove battery and start again  
 • There may be an interruption at the transmitter. Wait a few hours and try again  
 • Due to the signal requirements of these movements it is important that a fresh, fully charged alkaline battery is used initially and then changed on a regular basis as a partially charged battery may not be strong enough to receive the radio signal, resulting in the movement not fully functioning correctly

Code	Description	UOM	Price
J40133	11mm (NEF) Pendulum Movement, Radio Controlled	EACH	£14.75
J40134	18mm (NEF) Pendulum Movement, Radio Controlled	EACH	£14.75

Price breaks available, see website

## Reverse Time Keeping, UTS

Clock Movement - Reverse Time Keeping

- Reverse Motion Quartz UTS Movement
- Uses LR6 Battery
- As standard movement, with anti-clockwise hand direction
- Takes all Euroshaft hands

Dimensions:  
 • 57 x 57 x 17mm  
 • Shaft = From movement front to shaft tip

Euro Fitting (EF) Hand Collet Dimensions:  
 • Minute: 3.5 x 2.8mm  
 • Hour: Ø5.00mm

Code	Description	UOM	Price
J3138M	16mm Shaft (EF) Reverse Time Keeping Movement	EACH	£3.20

Price breaks available, see website

## Standard, Seiko



Clock Movement - Standard - Euro Fitting (EF) or Non Euro Fitting (NEF) - Seiko

- Standard Quartz Seiko Movements
- For Seiko calibres check see website "more info"
- Uses LR6 battery
- Complete with fittings
- Euro Fitting (EF) or Non Euro Fitting (NEF) hand shafts

Dimensions:  
 • 57 x 57 x 17mm  
 • Shaft = From movement front to shaft tip

Euro Fitting (EF) Hand Collet Dimensions:  
 • Minute: 3.8 x 2.8mm  
 • Hour: Ø5.0mm

Non Euro Fitting (NEF) Hand Collet Dimensions:  
 • Minute: Ø3.50mm  
 • Hour: Ø5.50mm

\* Non centre nut fixing model (secure with double sided tape)

Code	Description	UOM	Price
J39109	8mm* (NEF) Shaft Movement	EACH	£3.25
J39110	11.4mm (NEF) Shaft Movement	EACH	£3.25
J39106	12mm (EF) Shaft Movement	EACH	£3.95
J39111	13.2mm (NEF) Shaft Movement	EACH	£3.25
J39107	16.5mm (EF) Shaft Movement	EACH	£3.95
J47166	18mm (NEF) Shaft Movement	EACH	£3.75
J39108	21.9mm (EF) Shaft Movement	EACH	£3.95
J47165	26mm (EF) Shaft Movement	EACH	£3.95

Price breaks available, see website

## Standard, UTS



Clock Movement - Standard - Euro Fitting (EF) or Non Euro Fitting (NEF)

- Standard Quartz UTS Movements
- Uses LR6 battery
- Complete with fittings (including open minute hand nut)
- Euro Fitting (EF) or Non Euro Fitting (NEF) hand shafts
- Can take minute hands up to 160mm long, weighing up to 8 grams
- Can take centre seconds hands up to 90mm long, weighing up to 0.6 grams
- All fitting accessories available

Dimensions:

- 57 x 57 x 17mm
- Shaft = From movement front to shaft tip

Euro Fitting (EF) Hand Collet Dimensions:

- Minute: 3.8 x 2.8mm
- Hour: Ø5.0mm

Non Euro Fitting (NEF) Hand Collet Dimensions:

- Minute: Ø3.50mm
- Hour: Ø5.00mm

Code	Description	UOM	Price
J48213	8.5mm (NEF) Shaft Movement	EACH	£2.00
J486011	11mm (EF) Shaft Movement	EACH	£1.60
J40126	11mm (NEF) Shaft Movement	EACH	£2.00
J486013	13mm (EF) Shaft Movement	EACH	£1.60
J48214	13mm (NEF) Shaft Movement	EACH	£2.00
J486016	16mm (EF) Shaft Movement	EACH	£1.60
J40127	16mm (NEF) Shaft Movement	EACH	£2.00
J486021	21mm (EF) Shaft Movement	EACH	£1.60
J40128	21mm (NEF) Shaft Movement	EACH	£2.00
J486026	26mm (EF) Shaft Movement	EACH	£1.60

Price breaks available, see website

Strike & Chime, Hermle



Hermle 2114 - Quartz - Westminster & Bim-Bam Clock Movement

- Hermle 2114
- Dual Chime, Westminster & Bim Bam
- Speaker included
- Night shut off option
- Volume control
- Euro fitting hand shaft (EF)
- Half hour strike & 4/4 chime
- Can take minute hands up to 160mm long, weighing up to 8 grams
- Can take centre seconds hands up to 90mm long, weighing up to 0.6 grams

Euro Fitting (EF) Hand Collet Dimensions:

- Minute: 3.5 x 2.8mm
- Hour: Ø5.00mm

Dimensions:

- 90 x 75 x 30mm (H x W x D)
- Speaker Ø65mm
- Shaft = From movement front to shaft tip

Code	Description	UOM	Price
H28781	16mm (EF) Shaft Strike & Chime, Hermle	EACH	£24.75
H41935	20mm (EF) Shaft Strike & Chime, Hermle	EACH	£31.95

Strike & Chime, Seiko

Clock Movement - Seiko - Westminster & Whittingdon - Seiko



- Strike and chime quartz Seiko movements
- Dual Chime, Westminster & Whittingdon
- Hourly strike followed by the hourly chime
- Selective automatic chime silencer
- Volume control
- For Seiko calibres check see website "more info"
- Uses LR14 battery
- Complete with fittings & speaker wires
- \* = supplied without speaker
- Speaker code S37185
- Euro Fitting (EF) or Non Euro Fitting (NEF) hand shafts

Dimensions:

- 60 x 82 x 22mm
- Shaft = From movement front to shaft tip

Euro Fitting (EF) Hand Collet Dimensions:

- Minute: 3.5 x 2.8mm
- Hour: Ø5.00mm

Non Euro Fitting (NEF) Hand Collet Dimensions:

- Minute: Ø3.50mm
- Hour: Ø5.50mm

Code	Description	UOM	Price
J47169	15.5mm (NEF) Shaft Movement*	EACH	£19.95
J47170	16.5mm (EF) Shaft Movement	EACH	£19.95
J47171	29.1mm (EF) Shaft Movement*	EACH	£19.95

Price breaks available, see website

Strike & Chime with Pendulum, Hermle



Hermle 2214 - Quartz - Westminster & Bim-Bam Clock Movement

- Hermle 2214
- Dual Chime, Westminster & Bim Bam
- Pendulum unit
- Speaker included
- Night shut off option
- Volume control
- Euro fitting hand shaft (EF)
- Half hour strike & 4/4 chime
- Can take minute hands up to 160mm long, weighing up to 8 grams
- Can take centre seconds hands up to 90mm long, weighing up to 0.6 grams
- Can take pendulum length up to 500mm, max pendulum weight 80g

Euro Fitting (EF) Hand Collet Dimensions:

- Minute: 3.5 x 2.8mm
- Hour: Ø5.00mm

Dimensions:

- 110 x 72.5 x 25mm
- Speaker Ø65mm
- Shaft = From movement front to shaft tip

Code	Description	UOM	Price
H41936	16mm (EF) Shaft Strike & Chime Pendulum, Hermle	EACH	£32.95
H41937	20mm (EF) Shaft Strike & Chime Pendulum, Hermle	EACH	£32.95

Strike & Chime with Pendulum, Seiko

Clock Movement - Strike & Chime



- Strike and chime quartz Seiko movements with pendulum
- Dual Chime, Westminster & Whittingdon
- Can take minute hands up to 160mm long, weighing up to 6 grams
- Can take centre seconds hands up to 130mm long, weighing up to 2 grams
- Allowed Pendulum Length 120 to 350mm
- Allowed Pendulum Weight 40 to 60g
- Hourly strike followed by the hourly chime
- Selective Automatic Chime Silencer
- Volume Control
- Battery MN1400
- Complete with fittings & speaker wires
- \* = supplied without speaker
- Speaker code S37185
- Euro Fitting (EF) or Non Euro Fitting (NEF) hand shafts

Dimensions:

- 112 x 82 x 28mm (H x W x D)
- Shaft = From movement front to shaft tip

Euro Fitting (EF) Hand Collet Dimensions:

- Minute: 3.5 x 2.8mm
- Hour: Ø5.00mm

Non Euro Fitting (NEF) Hand Collet Dimensions:

- Minute: Ø3.50mm
- Hour: Ø5.50mm

Code	Description	UOM	Price
J47172	15.5mm (NEF) Shaft Movement*	EACH	£19.95
C20304	16.5mm (EF) Shaft Movement*	EACH	£20.95
J47173	29.1mm (EF) Shaft Movement, with Speaker	EACH	£21.95

Price breaks available, see website

Swiza Clock Movements



Swiza Clock Movements

- Swiza calibres 20, 21, 22, 25 & 26
- Made in Switzerland
- For full specification see website "more info"

Code	Description	UOM	Price
SWI20M	Swiza 20 Movement	EACH	£99.95
SWI21M	Swiza 21 Movement	EACH	£99.95
SWI22M	Swiza 22 Movement	EACH	£99.95
SWI25M	Swiza 25 Movement	EACH	£99.95
SWI26M	Swiza 26 Movement	EACH	£99.95

**Hand Held Engraving Machine**



**See Page 663**

## Tide Movements

Clock Movement - Tide - Non Euro Fitting (NEF)

A single handed Tide movement. The hand rotates at 12 hours and 25 minutes to the normal 12 hour rotation of other clocks. This is half the lunar cycle of 24 hours 50 minutes which governs high and low tides.

- Tide clock quartz movements
- Uses LR6 battery
- Complete with fittings (including open minute hand nut)
- Non Euro Fitting (NEF) hand shafts
- 57 x 57 x 16mm
- Made in China

Please note that the 24 hour 50 minutes is an average figure based on a 29 1/2 day cycle. Actual high and low tides may vary due to local wind conditions causing tides to be slightly earlier or later than indicated.

Code	Description	UOM	Price
J49178	8mm (NEF) Shaft Movement	EACH	£5.50
J49179	11mm (NEF) Shaft Movement	EACH	£5.50
J49180	16mm (NEF) Shaft Movement	EACH	£5.50
J49181	21mm (NEF) Shaft Movement	EACH	£5.50

Price breaks available, see website

## Movement Fittings, UTS



- Movement fittings
- Centre nuts, minute hand nuts, seconds caps, movement covers, hangers and rubber washers
- UTS Germany
- For all UTS movements

Code	Description	UOM	Price
J20344	Centre Nuts for 11mm Shaft (OL 6.40mm)	PACK*5	£1.00
J20345	Centre Nuts for 16mm Shaft (OL 10.20mm)	PACK*5	£1.00
J20346	Centre Nuts for 21mm Shaft (OL 14.10mm)	PACK*5	£1.25
J20347	Centre Nuts for 26mm Shaft (OL 17.20mm)	PACK*5	£1.50
J44371	Centre Nut for 26mm Shaft, Extra Long (OL 22mm)	EACH	£0.95
H46260	Centre Seconds Hand Caps (EF)	PACK*10	£2.50
H40135	Centre Seconds Hand Caps (NEF)	PACK*10	£1.25
J4860A	Minute Hand Nuts (Blind)	PACK*5	£0.95
H39202	Minute Hand Nuts (Blind) - Black	PACK*5	£0.95
J20349	Minute Hand Nuts (seconds)	PACK*10	£2.40
M44859	Movement Cover, Black	EACH	£0.50
J20350	Movement Hangers	PACK*5	£1.65
J4860B	Rubber Packing Washers	PACK*5	£2.20

## Speaker for Strike & Chime Movements

Speaker for strike & chime movements

- Ø65mm
- Overall depth 15mm (approx.)
- Seiko speaker
- Will fit Seiko or Hermle strike & chime movements



Code	Description	UOM	Price
S37185	SKP Seiko Movement Speaker	EACH	£2.95

# MOVEMENTS, QUARTZ INSERTIONS

## Barometer



Clock Movement - Barometer Insertion

- White or gold dial
- Gold bezel
- Ø55mm insert
- Ø65 or Ø70mm overall diameter

Code	Description	UOM	Price
B49165	Ø65mm White Dial Barometer	EACH	£13.95
B49164	Ø70mm Gold Dial Barometer	EACH	£13.95

## Hygrometer Inserts with Gold Dial



Hygrometer Inserts with Gold Dial & Black Hand

- For measuring humidity (e.g. dessert - moderate - tropical).
- Bezel Ø36, 54, 70 & 80mm
- Insert Ø32, 32 & 58mm

Dimensions: Outer Bezel Ø x Insert Ø

Code	Description	UOM	Price
I12504	Ø36mm x Ø32mm Hygrometer Insert	EACH	£9.50
I12505	Ø54mm x Ø32mm Hygrometer Insert	EACH	£9.50
I12506	Ø70mm x Ø58mm Hygrometer Insert	EACH	£13.50
I12507	Ø80mm x Ø58mm Hygrometer Insert	EACH	£13.50

## Thermometer Inserts with Gold Dial



Thermometer Inserts with Gold Dial & Black Hand

- For measuring temperature
- Bezel Ø36, 54 & 70mm
- Insert Ø32, 32 & 58mm

Dimensions: Outer Bezel Ø x Insert Ø

Code	Description	UOM	Price
I12500	Ø36mm x Ø32mm Thermometer Insert	EACH	£6.95
I12501	Ø54mm x Ø32mm Thermometer Insert	EACH	£8.95
I12502	Ø70mm x Ø58mm Thermometer Insert	EACH	£9.95

## Oval, Arabic Numerals



Clock Movement - Insertions with Arabic Numerals - Oval

- White Dials
- Arabic Numerals
- Gold or silver colour bezels
- Oval
- Approx 55mm insert size diameter
- Approx 17mm seating depth
- Will be supplied with either rubber ring fitting or metal clip fitting (fitting may vary depending on manufacturer's current supply)
- Fitting clips & rubber rings are interchangeable and are available separately, see codes I44164 & I44163
- UTS Germany

Dimensions (outer bezel diameter):

- 80 x 65mm

Code	Description	UOM	Price
I45559	80 x 65mm (Gold Bezel)	EACH	£9.95
I45561	80 x 65mm (Silver Bezel)	EACH	£9.95

Price breaks available, see website

## Oval, Roman Numerals



Clock Movement - Insertions with Roman Numerals - Oval

- White Dials
- Roman Numerals
- Oval
- Approx 55mm insert size diameter
- Approx 17mm seating depth
- Will be supplied with either rubber ring fitting or metal clip fitting (fitting may vary depending on manufacturer's current supply)
- Fitting clips & rubber rings are interchangeable and are available separately, see codes I44164 & I44163
- UTS Germany

Dimensions (outer bezel diameter):

- 80 x 65mm

Code	Description	UOM	Price
I45558	80 x 65mm (Gold Bezel)	EACH	£9.95
I45560	80 x 65mm (Silver Bezel)	EACH	£9.95

Price breaks available, see website

## Round, Alarm



Clock Movement - Insertions with Arabic Numerals - Alarm

- Gold dials
- Arabic Numerals
- Gold bezels
- Round
- Alarm feature
- Approx 55mm insert size diameter
- Approx 17mm seating depth
- Will be supplied with either rubber ring fitting or metal clip fitting (fitting may vary depending on manufacturer's current supply)
- Fitting clips & rubber rings are interchangeable and are available separately, see codes I44164 & I44163
- UTS Germany

Dimensions (outer bezel diameter):

- Ø72mm

Code	Description	UOM	Price
<b>I0874D</b>	Ø72mm (Gold Bezel) Alarm	EACH	<b>£10.15</b>
Price breaks available, see website			

**Round, Arabic Numerals**



Clock Movement - Insertions with Arabic Numerals - Round

- White Dials
- Arabic Numerals
- Gold or silver colour bezels
- Round
- Approx 55mm insert size diameter
- Approx 17mm seating depth
- Will be supplied with either rubber ring fitting or metal clip fitting (fitting may vary depending on manufacturer's current supply)
- Fitting clips & rubber rings are interchangeable and are available separately, see codes I44164 & I44163
- UTS Germany

Dimensions (outer bezel diameter):

- Ø66mm
- Ø72mm
- Ø85mm
- Ø103mm

Code	Description	UOM	Price
<b>I0870D</b>	Ø66mm (Gold Bezel)	EACH	<b>£7.45</b>
<b>I45600</b>	Ø66mm (Silver Bezel)	EACH	<b>£7.45</b>
<b>I0871D</b>	Ø72mm (Gold Bezel)	EACH	<b>£8.10</b>
<b>I45602</b>	Ø72mm (Silver Bezel)	EACH	<b>£8.10</b>
<b>I45608</b>	Ø85mm (Gold Bezel)	EACH	<b>£8.45</b>
<b>I45604</b>	Ø85mm (Silver Bezel)	EACH	<b>£8.45</b>
<b>I0873D</b>	Ø103mm (Gold Bezel)	EACH	<b>£8.80</b>
<b>I45606</b>	Ø103mm (Silver Bezel)	EACH	<b>£8.80</b>
Price breaks available, see website			



**Quartz Clock Insertion Battery**

**See Page 8**

**Round, Roman Numerals**



Clock Movement - Insertions with Roman Numerals - Round

- White Dials
- Roman Numerals
- Gold or silver colour bezels
- Round
- Approx 55mm insert size diameter
- Approx 17mm seating depth
- Will be supplied with either rubber ring fitting or metal clip fitting (fitting may vary depending on manufacturer's current supply)
- Fitting clips & rubber rings are interchangeable and are available separately, see codes I44164 & I44163
- UTS Germany

Dimensions (outer bezel diameter):

- Ø66mm
- Ø72mm
- Ø85mm
- Ø103mm

Code	Description	UOM	Price
<b>I0870B</b>	Ø66mm (Gold Bezel)	EACH	<b>£7.45</b>
<b>I45601</b>	Ø66mm (Silver Bezel)	EACH	<b>£6.85</b>
<b>I0871B</b>	Ø72mm (Gold Bezel)	EACH	<b>£8.10</b>
<b>I45603</b>	Ø72mm (Silver Bezel)	EACH	<b>£8.10</b>
<b>I0872B</b>	Ø85mm (Gold Bezel)	EACH	<b>£8.45</b>
<b>I45605</b>	Ø85mm (Silver Bezel)	EACH	<b>£8.45</b>
<b>I0873B</b>	Ø103mm (Gold Bezel)	EACH	<b>£8.80</b>
<b>I45607</b>	Ø103mm (Silver Bezel)	EACH	<b>£8.60</b>
Price breaks available, see website			

**Round, Mini**



Clock Movement - Mini Quartz Insert Heads

- White & Gold Dials
- Arabic & Roman Numerals
- Dial patterns may vary
- Rubber ring fitting
- Supplied with battery

Dimensions: Outer Bezel Diameter x Insert Diameter

- Ø25 x 22mm
- Ø35 x 32mm
- Ø36 x 34mm
- Ø42 x 35mm

Running on one watch cell with hand adjustment via crown hidden @ three o'clock position.

Code	Description	UOM	Price
<b>M20301</b>	Ø25mm (Chrome) Arabic	EACH	<b>£4.90</b>

<b>M20300</b>	Ø25mm (Chrome) Roman	EACH	<b>£4.90</b>
<b>M20299</b>	Ø25mm (Gold) Arabic	EACH	<b>£4.90</b>
<b>M20298</b>	Ø25mm (Gold) Roman	EACH	<b>£4.90</b>
<b>M20305</b>	Ø35mm (Chrome) Arabic	EACH	<b>£4.90</b>
<b>M20304</b>	Ø35mm (Chrome) Roman	EACH	<b>£4.90</b>
<b>M20303</b>	Ø35mm (Gold) Arabic	EACH	<b>£4.90</b>
<b>M20302</b>	Ø35mm (Gold) Roman	EACH	<b>£4.90</b>
<b>I0869B</b>	Ø36mm (Chrome) Roman, UTS	EACH	<b>£8.80</b>
<b>I0869A</b>	Ø36mm (Gold) Roman, UTS	EACH	<b>£8.80</b>
<b>I0869C</b>	Ø36mm (Gold) Arabic, UTS	EACH	<b>£8.80</b>
<b>M20307</b>	Ø42mm (Gold) Arabic	EACH	<b>£6.50</b>
<b>M20306</b>	Ø42mm (Gold) Roman	EACH	<b>£6.50</b>
Price breaks available, see website			

**Insertion Fittings**



Insertion Fittings

- Rubber Rings - One size fits all our insertion sizes
- Metal Clips - One size fits all our insertion sizes

Code	Description	UOM	Price
<b>I44164</b>	Clips for Insertions	PACK*4	<b>£0.85</b>
<b>I44163</b>	Rubber Rings for Insertions	EACH	<b>£0.75</b>
Price breaks available, see website			

**Round Mini Gaskets**



Clock Movement - Mini Quartz Insert Head Gaskets

Gaskets for our range of mini quartz insertion heads

- For Ø25mm Movements
- For Ø35mm Movements
- For Ø42mm Movements

Code	Description	UOM	Price
<b>G35426</b>	Ø25mm Insertion Gaskets	PACK*10	<b>£2.95</b>
<b>G35427</b>	Ø35mm Insertion Gaskets	PACK*10	<b>£2.95</b>
<b>G35428</b>	Ø42mm Insertion Gaskets	PACK*10	<b>£2.95</b>



**Buff Sticks, Leather & Felt**

**See Page 1148**

**Plastic Glass Polishing Paste**

**See Page 1174**

**NUMERALS**

**NUMERAL TEMPLATE**

**Numeral Positioning Template**

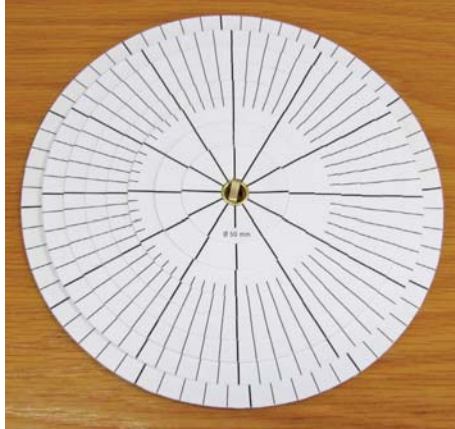

Clock Dial Numeral Positioning Template

Set of 8 sturdy discs to accurately plot numerals and hour/minute marker sites on dials etc. Reusable diameters: Ø50, 75, 100, 120, 140, 160, 180, 200 mm.

- Positioning Template
- 8 diameters
- Sturdy discs
- Accurate markings
- Made in Germany

Code	Description	UOM	Price
T7870	Dial Transfer Positioning Template	EACH	£18.95

**NUMERAL TRANSFER**

**Numeral Transfer Set**



Clock Dial Numeral Transfer Set

Damp sponge, application to metal, wood, glass or plastic.

- Roman
- Ø160mm
- Numeral Height 26mm

Code	Description	UOM	Price
N12414	Wet Numeral Transfer Set	EACH	£8.95



**ORDER tracking**

**ARABIC NUMERALS**

**Metal (Aluminium) Brass Colour, Arabic Numbers**



Heights available: 18, 25 & 30mm

- Brass colour aluminium
- Arabic
- 0.70mm thick
- Numeral heights: 18, 25 & 33mm

Styles:

- Numerals 1 to 12 Set

Code	Description	UOM	Price
N46263	18mm High Numerals Set	EACH	£2.95
N46262	25mm High Numerals Set	EACH	£2.95
N47682	33mm High Numerals Set	EACH	£2.95

**Metal (Brass) Black, Arabic Numbers**

Heights available: 10, 15 & 20mm

- Brass with matt black finish
- Brass Filed Edge
- Arabic
- 0.50mm thick brass
- Numeral heights: 10mm, 15mm & 20mm



Code	Description	UOM	Price
N12441	10mm High Numerals	EACH	£16.85
N12442	15mm High Numerals	EACH	£17.35
N12443	20mm High Numerals	EACH	£17.35

**Metal (Brass) Black, Arabic Numbers Batons**



Heights available: 12, 15, 16, 20 & 25mm

- Brass with black finish
- Arabic with batons

- 0.50mm thick brass base
- Numeral heights: 12mm, 15mm, 16mm, 20mm & 25mm

Minimum outer diameter:

- Ø60mm N12430
- Ø95mm N12431
- Ø100mm N0999
- Ø120mm N12425\*
- Ø120mm N0993
- Ø150mm N12426

\* 1mm thick with brass bevelled edges

Code	Description	UOM	Price
N12430	Style 1 (12mm) High Numerals	EACH	£16.85
N12431	Style 1 (15mm) High Numerals	EACH	£17.35
N0999	Style 1 (16mm) High Numerals	EACH	£17.35
N12425	Style 2 (20mm) High Numerals*	EACH	£17.35
N0993	Style 3 (20mm) High Numerals	EACH	£17.35
N12426	Style 3 (25mm) High Numerals	EACH	£17.35

**Metal (Brass) Brass Colour, Arabic Numbers**

Heights available: 10, 15, 20 & 25mm

- Brass
- Arabic
- 0.50mm thick brass base with satin finish
- Numeral heights: 10mm, 15mm, 20mm & 25mm



Code	Description	UOM	Price
N12437	10mm High Numerals	EACH	£16.85
N12438	15mm High Numerals	EACH	£16.85
N12439	20mm High Numerals	EACH	£17.35
N12440	25mm High Numerals	EACH	£17.35

**Metal (Brass) Brass Colour, Arabic Numbers & Batons**



Heights available: 12, 15, 16, 18 & 20mm

- Brass
- Arabic with batons
- 0.50mm thick brass base
- Numeral heights: 12mm, 15mm, 16mm, 18mm & 20mm

Minimum outer diameter:

- Ø60mm N12428
- Ø95mm N12429
- Ø100mm N0998
- Ø110mm N12427
- Ø115mm N0992
- Ø120mm N12424

Code	Description	UOM	Price
N12428	Style 1 (12mm High) Numerals	EACH	£16.85
N12429	Style 1 (15mm High) Numerals	EACH	£17.35
N0998	Style 1 (16mm High) Numerals	EACH	£17.35
N12427	Style 2 (18mm High) Numerals	EACH	£17.35
N0992	Style 2 (19mm High) Numerals	EACH	£17.35
N12424	Style 2 (20mm High) Numerals	EACH	£17.35



**TRADE SUPPLIER**

**Metal (Stainless Steel) Brass  
Colour, Arabic Numbers**



Heights available: 32mm

- Stainless steel plated brass
- Brass colour
- High quality
- Arabic
- 0.40mm thick
- Numeral heights: 32mm

Styles:

- Numerals 1 to 12 Set

Code	Description	UOM	Price
N48926	32mm High, Titanium Numerals (Arabic)	EACH	£4.95

**Metal (Titanium) Brass  
Colour, Arabic Numbers**



Heights available: 32mm

- Titanium plated brass
- Brass colour
- High quality
- Strong & durable
- Arabic
- 0.40mm thick
- Numeral heights: 32mm

Styles:

- Numerals 1 to 12 Set

Code	Description	UOM	Price
N48927	32mm High, Titanium Numerals (Arabic)	EACH	£15.95

**Plastic Arabic Numbers**

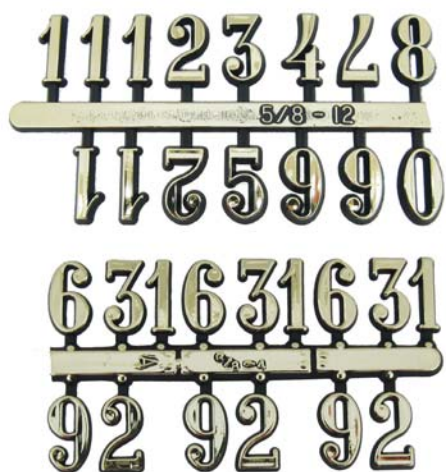

Heights available: 8, 10, 12.5, 16, 21 & 25mm

- Gold Finish on Black Plastic
- Self Adhesive Backing

- Supplied on Break Away Sprues
- Various Heights

Styles:

- Style 1 = Numerals 1 to 12
- Style 2 = Numerals 3, 6, 9 & 12 Only (3 sets per sprue)

Code	Description	UOM	Price
N1014	Style 1 (10mm High) Numerals	EACH	£1.95
N41889	Style 1 (12.5mm High) Numerals	EACH	£1.50
N1015	Style 1 (16mm High) Numerals	EACH	£1.95
N1016	Style 1 (21mm High) Numerals	EACH	£1.95
N1017	Style 1 (25mm High) Numerals	EACH	£1.95
N1006	Style 2 (8mm High) Numerals	EACH	£1.95
N1007	Style 2 (16mm High) Numerals	EACH	£1.95
N1008	Style 2 (21mm High) Numerals	EACH	£1.95
N1009	Style 2 (25mm High) Numerals	EACH	£1.95

**Plastic Arabic Numbers & Batons**

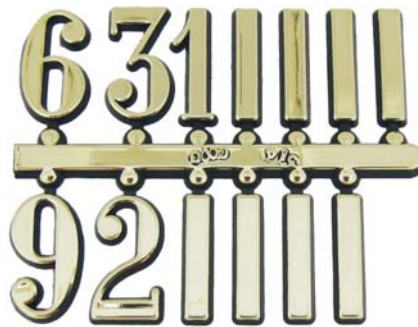

Heights available: 16, 19 & 25mm

- Gold Finish on Black Plastic
- Self Adhesive Backing
- Supplied on Break Away Sprues
- Various Heights

Style:

- Numerals 3, 6, 9, 12 & Batons (8)

Code	Description	UOM	Price
N1028	16mm High Numerals	EACH	£1.95
N1029	19mm High Numerals	EACH	£1.95
N1030	25mm High Numerals	EACH	£1.95

**Plastic Arabic Numbers & Dots**



Heights available: 16, 19 & 25mm

- Gold Finish on Black Plastic
- Self Adhesive Backing
- Supplied on Break Away Sprues
- Various Heights

Style:

- Numerals 3, 6, 9, 12 & Dots (8)

Code	Description	UOM	Price
N1022	16mm High Numerals	EACH	£1.95
N1023	19mm High Numerals	EACH	£1.95
N1024	25mm High Numerals	EACH	£1.95

**BATONS & DOTS**

**Batons (Metal)**



Metal Brass with Black Line Markers

- Brass
- 0.50mm Thick
- Brass with Black Line
- Heights 17mm
- Made in Germany

Minimum Outer Diameter:

- 17mm = Ø80mm

Code	Description	UOM	Price
N12433	17mm High Batons	EACH	£11.50

**Batons (Plastic)**

Plastic Clock Dial Batons

- Gold
- Self adhesive
- Plastic
- 11, 16 or 19mm tall



Code	Description	UOM	Price
B41890	11mm Batons	PACK*12	£1.50
B41891	16mm Batons	PACK*12	£1.50
B41892	19mm Batons	PACK*12	£1.50

**Dots (Plastic)**

Plastic Clock Dial Dots

- Gold
- Self adhesive
- Plastic
- Ø6 or 10mm



Code	Description	UOM	Price
D41893	Ø6mm Dot	PACK*12	£1.50
D41894	Ø10mm Dot	PACK*12	£1.50

**Adhesives,  
Cements  
& Tapes**



See Page: 1149

**ROMAN NUMERALS**

**Metal (Aluminium) Brass Colour, Roman Numbers**

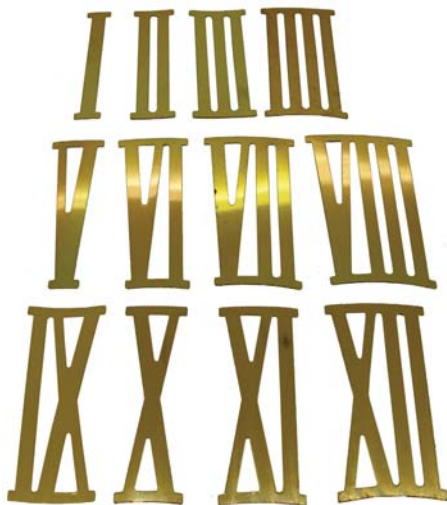

Heights available: 27 & 42mm

- Brass coloured aluminium
- Roman
- 0.40mm thick
- Numeral heights: 27 & 42mm

Styles:  
• Numerals 1 to 12 Set

Code	Description	UOM	Price
N46264	27mm High Numerals Set	EACH	£2.95
N46261	42mm High Numerals Set	EACH	£2.95

**Metal (Black) Roman Numbers**



Heights available: 10, 16, 20, 21 & 25mm

- Brass with black finish
- Roman
- 0.50mm thick
- Numeral heights: 10mm, 16mm 20mm, 21mm & 25mm

Styles:  
• Numerals 1 to 12

Code	Description	UOM	Price
N1005	10mm High Numerals	EACH	£7.95
N1001	16mm High Numerals	EACH	£7.95
N12422	20mm High Numerals	EACH	£6.80
N0997	21mm High Numerals	EACH	£7.95
N1003	25mm High Numerals	EACH	£7.95

**Metal (Brass) Black, Roman Numbers, Gothic**



Heights available: 20mm

- Brass with black finish
- Gothic style
- Roman
- 0.50mm thick
- Numeral heights: 20mm

Styles:  
• Numerals 1 to 12

Code	Description	UOM	Price
N0991	20mm High Numerals	EACH	£7.95

**Metal (Brass) Black, Roman Numbers, Superior**



Heights available: 10, 15 & 25mm

- Brass with matt black finish
- Brass Filled Edge
- Superior Finish
- Roman
- 0.80 to 1.00mm Thick
- Numeral heights: 10mm, 15mm & 25mm

Styles:  
• Numerals 1 to 12

Code	Description	UOM	Price
N12420	10mm High Numerals	EACH	£19.25
N12421	15mm High Numerals	EACH	£19.25
N12423	25mm High Numerals	EACH	£19.25

**Metal (Brass) Brass Colour, Roman Numbers**

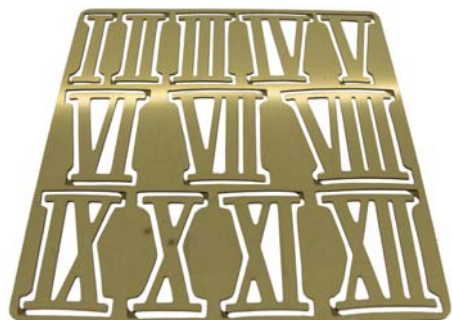

Heights available: 10, 12, 15, 20, 22 & 25mm

- Brass
- Roman
- 0.50mm thick
- Numeral heights: 10mm, 12mm, 15mm, 20mm, 22mm & 25mm
- Made in Germany

Styles:  
• Numerals 1 to 12

Code	Description	UOM	Price
N12415	10mm High Numerals	EACH	£17.50
N12416	12mm High Numerals	EACH	£17.85
N12417	15mm High Numerals	EACH	£17.95
N12418	20mm High Numerals	EACH	£18.50
N0996	22mm High Numerals	EACH	£18.50
N1002	25mm High Numerals	EACH	£18.50
N48931	25mm High Numerals (China), 1.10mm Thick	EACH	£12.95

**Metal (Brass) Brass Colour, Roman Numbers, Gothic**



Heights available: 20mm

- Brass
- Gothic style
- Roman
- 0.50mm thick
- Numeral heights: 20mm
- Made in Germany

Styles:  
• Numerals 1 to 12

Code	Description	UOM	Price
N0990	20mm High Numerals	EACH	£17.95

**Metal (Brass) Brass Colour, Roman Numbers, Superior**



Heights available: 25mm

- Brass
- Brass Filled Edge
- Superior Finish
- Roman
- 0.50mm Thick
- Numeral heights: 25mm

Styles:  
• Numerals 1 to 12

Code	Description	UOM	Price
N12419	25mm High Numerals	EACH	£18.75

**Metal (Stainless Steel) Brass Colour, Roman Numbers**



Heights available: 28 & 43mm

- Stainless steel plated brass





- Brass colour
- High quality
- Roman
- 0.40mm thick
- Numeral heights: 28 & 43mm

- Styles:
- Numerals 1 to 12 Set

Code	Description	UOM	Price
N48928	28mm High Numerals Set	EACH	£4.95
N48930	43mm High Numerals Set	EACH	£11.95

**Metal (Titanium) Brass Colour, Roman Numbers**



Heights available: 28mm

- Titanium plated brass
- Brass colour
- High quality
- Strong & durable
- Roman
- 0.40mm thick
- Numeral heights: 28mm

- Styles:
- Numerals 1 to 12 Set

Code	Description	UOM	Price
N48929	28mm High Numerals Set	EACH	£15.95

**Plastic Roman Numbers**

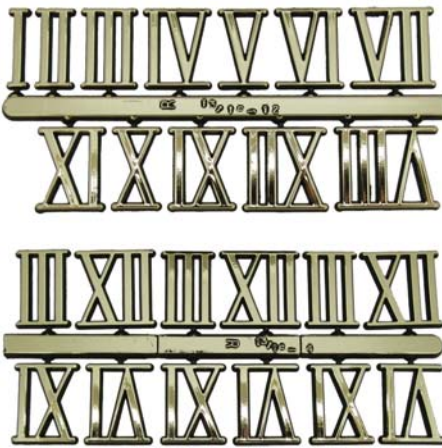

Heights available: 8, 10, 12.5, 16, 21 & 25mm

- Gold Finish on Black Plastic
- Self Adhesive Backing
- Supplied on Break Away Sprues

- Styles:
- Style 1 = Numerals 1 to 12
  - Style 2 = Numerals 3, 6, 9 & 12 Only

Code	Description	UOM	Price
N1018	Style 1 (10mm High) Numerals	EACH	£1.95
N41888	Style 1 (12.5mm High) Numerals	EACH	£1.50
N1019	Style 1 (16mm High) Numerals	EACH	£1.95
N1020	Style 1 (21mm High) Numerals	EACH	£1.95
N1021	Style 1 (25mm High) Numerals	EACH	£1.95
N1010	Style 2 (8mm High) Numerals	EACH	£1.95
N1011	Style 2 (16mm High) Numerals	EACH	£1.95
N1012	Style 2 (21mm High) Numerals	EACH	£1.95
N1013	Style 2 (25mm High) Numerals	EACH	£1.95

**Plastic Roman Numbers & Batons**



Heights available: 16, 19 & 25mm

- Gold Finish on Black Plastic
- Self Adhesive Backing
- Supplied on Break Away Sprues

- Style:
- Numerals 3, 6, 9, 12 & Batons (8)

Code	Description	UOM	Price
N1031	16mm High Numerals	EACH	£1.95
N1032	19mm High Numerals	EACH	£1.95
N1033	25mm High Numerals	EACH	£1.95

**Plastic Roman Numbers & Dots**

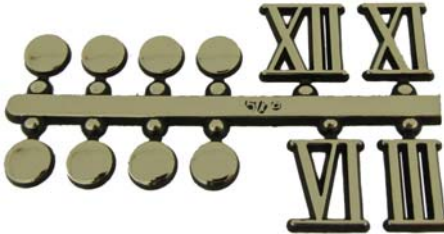

Heights available: 16, 19 & 25mm

- Gold Finish on Black Plastic
- Self Adhesive Backing
- Supplied on Break Away Sprues

- Style:
- Numerals 3, 6, 9, 12 & Dots (8)

Code	Description	UOM	Price
N1025	16mm High Numerals	EACH	£1.95
N1026	19mm High Numerals	EACH	£1.95
N1027	25mm High Numerals	EACH	£1.95

**Roman Cartouche Enamel Style**

Heights available: 25, 27, 29 & 45mm

- Enamel Style
- Various Heights
- Various Styles
- Made in Germany or unbranded

- Styles:
- Numerals 1 to 12

Dimensions: Height x Width (overall)

**Numerals for Cuckoo Dials (Plastic)**



**See Page 1232**

**25mm (21mm) Numerals, German**



- Brass / White
- 3.5mm thick
- Brass border
- Black Roman numerals on white background
- Minimum outer diameter Ø120mm
- Made in Germany

Code	Description	UOM	Price
N12434	25mm (21mm) Numerals, German	EACH	£22.90

**27mm (24mm) Numerals, German**



- Brass / White
- 2.5mm thick
- Brass border
- Black Roman numerals on white background
- Minimum outer diameter Ø200mm
- Made in Germany

Code	Description	UOM	Price
N12435	27mm (24mm) Numerals, German	EACH	£21.90

**29mm (24mm) Numerals, German**



- Brass / White
- 3.5mm thick
- Brass border
- Black Roman numerals on white background
- Minimum outer diameter Ø200mm
- Made in Germany

Code	Description	UOM	Price
N12436	29mm (24mm) Numerals, German	EACH	£21.90

**45mm (35mm) Numerals**



- Brass / White
- 3.5mm thick
- Brass border
- Black Roman numerals on white background

Code	Description	UOM	Price
N46265	45mm (35mm) Numerals	EACH	£2.50

## ZODIAC STAR SIGN FIGURES

### Zodiac Star Signs, Black



Zodiac - Star Signs - Black Figures

- 12 Star Signs
- Black Metal
- Height 20mm Approx.

Code	Description	UOM	Price
N0995	Zodiac (Star Signs) Black	EACH	£7.95

### Zodiac Star Signs, Brass



Zodiac - Star Signs - Brass Figures

- 12 Star Signs
- Brass
- Height 20mm Approx.

Code	Description	UOM	Price
N0994	Zodiac (Star Signs) Brass	EACH	£7.95

## PALLETS

### Gathering Pallets, Longcase



Long Case Clock - Gathering Pallets

Ready for final fitting, the pallet has the pilot hole drilled ready for a square to be filed to fit the respective clock, supplied in front of rack locking & rear of rack locking.

- L0912A - front gathering pallet blank (left)
- L0912B - rear gathering pallet blank (right)
- Steel
- Made in UK

Dimensions (approximate):

- 24.5 x 4.5mm (length x height)
- Hole size Ø0.15mm

Code	Description	UOM	Price
L0912A	Front Gathering Pallet Blank	EACH	£8.15
L0912B	Rear Gathering Pallet Blank	EACH	£8.15

### Pallets Complete, American Ansonia



American Ansonia Clock Pallets

- Assorted (Verges)
- 9 Pieces with Crutch Rods
- Various Steel Jaw Opening Sizes
- Made in Germany

Code	Description	UOM	Price
P4952	American Ansonia Clock Pallets	PACK*9	£6.25

### Clock Pallet Jaws



Clock Pallet Jaws

For restoring anchor type escapements (dead beat or recoil)

- Preformed ready for finishing.
- Solid Steel
- 9 pieces
- Made in Germany

Set includes:

- 30.5 x 23 x 18mm
- 28 x 18 x 11mm
- 28.5 x 19 x 13mm
- 27 x 18 x 13mm
- 26 x 18 x 12mm
- 20.5 x 12 x 9mm
- 17.5 x 6.5 x 10.5mm
- 17 x 11.5 x 7.5mm
- 15 x 7 x 9mm

Dimensions:

- Outer width x inner jaw width x overall height
- Dimensions are approx.

Code	Description	UOM	Price
P7867	Clock Pallet Jaws Assorted	PACK*9	£29.95



### American Ansonia Clock Pallet Jaws



American Ansonia Clock Pallet Jaws

- 12 Assorted Steel Pallet Jaws
- Pre-angled but Adjustable for American Type Escapements
- Without Crutch Rod
- Made in Germany

Code	Description	UOM	Price
P8940	American Ansonia Clock Pallet Jaws	PACK*12	£13.75

### Pallet Jaw Blanks, English Dial

English Dial, Fusee - Pallet Blank

Fusee pallet blank manufactured from 4mm carbon steel.



Dimensions:

- Total width 40mm
- Total height 25mm
- Gap between pallets 20mm
- Carbon steel

Made in UK

Code	Description	UOM	Price
P8841	Fusee Pallet Blank	EACH	£4.45

### Pallet Blanks, Longcase



Long Case Clock - Pallet Blanks

Style 1 (L0919):

A basic 4mm thick carbon steel blank for manufacturing long case pallets.

- Total Height 25.30mm
- Total Width 49.85mm
- Gap between Pallets 20.60mm

Style 2 (L34559):

Suited to earlier movements with a small escape wheel and narrow swing.

- Total Height 30mm
- Total Width 39mm
- Gap between Pallets 23mm

Style 3 (L48772):

The pallet that is included in our escapement set C34653

- Total Height TBAm
- Total Width TBAm
- Gap between Pallets TBAm

Code	Description	UOM	Price
L0919	Pallet Blank, Style 1	EACH	£3.95
L34559	Pallet Blank, Style 2	EACH	£3.95
L48772	Pallet Blank, Style 3	EACH	£3.95



**Pallet Stones, Brocot**



Brocot Clock Pallet Stone

- Previously known as Cornelian Pallet Stones
- 6 sizes
- Hard red ruby type material
- Suitable for visible escapement clocks
- All 6mm long

The manufacturer advises these pallet stones are factory standard finish, the surface area of the cylinder will not necessarily be finished and polished to the same level as the flat. The cylinder surface being unpolished however is advantageous when fixing the stone for final finishing.

The Pallet stone can be finished using a product such as diamantine.

Code	Description	UOM	Price
P8891	Ø1.83mm Brocot Pallet Stone	EACH	£8.95
P8892	Ø1.90mm Brocot Pallet Stone	EACH	£8.95
P8893	Ø2.00mm Brocot Pallet Stone	EACH	£8.95
P8894	Ø2.15mm Brocot Pallet Stone	EACH	£8.95
P8895	Ø2.25mm Brocot Pallet Stone	EACH	£8.95
P8896	Ø2.35mm Brocot Pallet Stone	EACH	£8.95
P49209	Ø2.50mm Brocot Pallet Stone	EACH	£12.95
P49210	Ø3.00mm Brocot Pallet Stone	EACH	£12.95

Price breaks available, see website

**PENDULUM BEAT PLAQUES**

**Pendulum Beat Plaque, Aluminium**



Pendulum Beat Plaque - Aluminium

- Aluminium
- Imitation enamel finish and black border line
- Dimensions: 62mm x 26mm x 0.40mm
- Made in Germany

Code	Description	UOM	Price
E7759	Pendulum Beat Plaque	EACH	£7.10

**Pendulum Beat Plaque, Brass**



Pendulum Beat Plaque - Brass

- Brass
- For large pendulum clocks
- 140mm x 23mm
- Antique lacquered
- Made in Germany

Code	Description	UOM	Price
E8324	Pendulum Beat Plaque	EACH	£21.30

**PENDULUM LEADERS**

**Leaders**

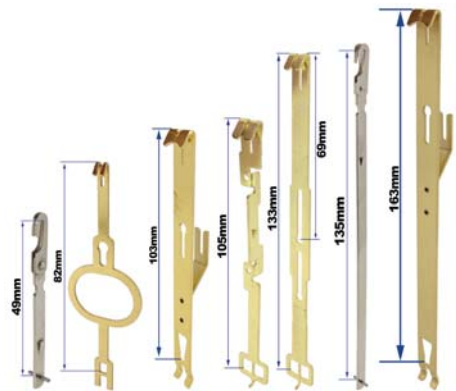

Universal Pendulum Leaders including models for Hermle (E002 & B026) & Kieninger (B.044)

- For bracket, wall and mantle clocks
- Various styles & lengths
- Also for Hermle & Kieninger
- Made in Germany

Dimensions: Top Pin or Hook to Pendulum Attachment Point

For specific model information see website "More Info"

Code	Description	UOM	Price
L7779	49mm Leader	EACH	£4.95
HER29006	82mm Leader	EACH	£2.95
L48185	103mm Leader	EACH	£4.95
L9603	105mm Leader	EACH	£4.95
L9604	133mm (69mm) Leader	EACH	£5.95
L7780	135mm Leader	EACH	£14.85
L48186	163mm Leader	EACH	£8.95

**PENDULUMS (MECHANICAL) & PENDULUM PARTS**

*Pendulums that are specifically to brand (Hermle) have the dimensions given to enable them to be universally used on any clock.*

**ANSONIA PENDULUMS**

**American Ansonia Pendulums**



American Ansonia Pendulums

Universal bobs & fittings can be adjusted and made to fit many types of clocks

- Bobs
- Bob Wires
- Can be used as universal

• Dimensions are approximate

Code	Description	UOM	Price
P31294	Ø35mm Pendulum Bob with Wire	EACH	£3.30
P4947	Ø43mm Pendulum Bob with Wire (Ansonia 1 Day)	EACH	£4.25
P4946	Ø52mm Pendulum Bob with Wire (Ansonia 8 Day)	EACH	£4.95
P32040	Bob Wire with Nut, Length 70mm	EACH	£0.95
P4950	Bob Wire with Nut, Length 90mm	EACH	£1.20
P32041	Bob Wire with Nut, Length 110mm	EACH	£1.45

**CUCKOO PENDULUMS**

**Chalet**

Pendulums - Cuckoo Clock Chalet



- Chalet
- Brown or unfinished
- Hook and fittings included
- Rod is adjustable
- Original black forest pendulums
- Made in Germany

Dimensions:

- Colour, Rod length x chalet width at widest point

Code	Description	UOM	Price
P43225	Brown, 170 x 40mm	EACH	£4.25
P44206	Brown, 190 x 60mm	EACH	£4.95
P43226	Brown, 210 x 65mm	EACH	£4.75
P43222	Unfinished, 170 x 40mm	EACH	£3.95
P44205	Unfinished, 190 x 60mm	EACH	£3.95
P43223	Unfinished, 210 x 65mm	EACH	£4.65

**Maple Leaf**



Pendulums - Cuckoo Clock Maple Leaf

- Maple leaf
- Brown, blonde, green or unfinished
- Hook and fittings included
- Rod is adjustable
- Original black forest pendulums
- Made in Germany

Dimensions:

- Colour, Rod length x leaf width at widest point

Code	Description	UOM	Price
P43205	Brown, 170 x 50mm	EACH	£4.25
P43206	Brown, 190 x 60mm	EACH	£4.35
P43207	Brown, 210 x 75mm	EACH	£4.65
P43208	Blonde, 170 x 50mm	EACH	£4.25
P43209	Blonde, 190 x 60mm	EACH	£4.35
P43210	Blonde, 210 x 75mm	EACH	£4.65
P43211	Green, 170 x 50mm	EACH	£4.50
P43212	Green, 190 x 60mm	EACH	£4.75
P43213	Green, 210 x 75mm	EACH	£4.95

# PENDULUMS (MECHANICAL) & PENDULUM PARTS

<b>P43202</b>	Unfinished, 170 x 50mm	EACH	<b>£3.95</b>
<b>P43203</b>	Unfinished, 190 x 60mm	EACH	<b>£3.95</b>
<b>P43204</b>	Unfinished, 210 x 75mm	EACH	<b>£3.95</b>

## Oak Leaf



Pendulums - Cuckoo Clock Oak Leaf

- Oak leaf
- Brown, blonde, green or unfinished
- Hook and fittings included
- Rod is adjustable
- Original black forest pendulums
- Made in Germany

Dimensions:

- Colour, Rod length x leaf width at widest point

Code	Description	UOM	Price
<b>P43215</b>	Brown, 190 x 60mm	EACH	<b>£4.35</b>
<b>P43219</b>	Brown, 210 x 75mm	EACH	<b>£4.75</b>
<b>P43216</b>	Blonde, 190 x 60mm	EACH	<b>£4.35</b>
<b>P43220</b>	Blonde, 210 x 75mm	EACH	<b>£4.95</b>
<b>P43217</b>	Green, 190 x 60mm	EACH	<b>£4.75</b>
<b>P43221</b>	Green, 210 x 75mm	EACH	<b>£4.75</b>
<b>P43214</b>	Unfinished, 190 x 60mm	EACH	<b>£3.45</b>
<b>P43218</b>	Unfinished, 210 x 75mm	EACH	<b>£3.65</b>

## Oak Leaf Fancy

Pendulums - Cuckoo Clock Oak Leaf Fancy

- Fancy oak leaf
- Brown or unfinished
- Hook and fittings included
- Rod is adjustable
- Original black forest pendulums
- Made in Germany



Dimensions:

- Colour, Rod length x leaf width at widest point

Code	Description	UOM	Price
<b>P43229</b>	Brown, 190 x 60mm	EACH	<b>£4.95</b>
<b>P43228</b>	Unfinished, 190 x 60mm	EACH	<b>£4.65</b>

## Pendulum Sticks



Pendulums - Cuckoo Clock Pendulum Sticks

- Sticks
- Brown or unfinished
- Rod can be shortened to required length

- Original black forest pendulums
- Made in Germany

Dimensions:

- Colour, Rod length

Code	Description	UOM	Price
<b>P44334</b>	Brown, 14cm	EACH	<b>£0.50</b>
<b>P44335</b>	Brown, 15cm	EACH	<b>£0.55</b>
<b>P44337</b>	Brown, 17cm	EACH	<b>£0.65</b>
<b>P44338</b>	Brown, 19cm	EACH	<b>£0.70</b>
<b>P44339</b>	Brown, 21cm	EACH	<b>£0.75</b>
<b>P44340</b>	Brown, 25cm	EACH	<b>£0.80</b>
<b>P44341</b>	Brown, 35cm	EACH	<b>£0.85</b>
<b>P44342</b>	Brown, 40cm	EACH	<b>£0.90</b>
<b>P44344</b>	Unfinished, 15cm	EACH	<b>£0.35</b>
<b>P44346</b>	Unfinished, 17cm	EACH	<b>£0.45</b>
<b>P44347</b>	Unfinished, 19cm	EACH	<b>£0.50</b>
<b>P44348</b>	Unfinished, 21cm	EACH	<b>£0.55</b>
<b>P44349</b>	Unfinished, 25cm	EACH	<b>£0.60</b>
<b>P44350</b>	Unfinished, 35cm	EACH	<b>£0.65</b>
<b>P44351</b>	Unfinished, 40cm	EACH	<b>£0.70</b>

## Pendulum Fittings



Pendulum Fittings - Cuckoo Clock

- Pendulum hook and slider
- For cuckoo clock pendulums

Code	Description	UOM	Price
<b>P44352</b>	Pendulum Hook & Slider	EACH	<b>£0.95</b>

Price breaks available, see website

## CYLINDER PENDULUMS

### Cylinder Pendulum

Cylinder Pendulums

- Rod & Cylinder
- Polished brass colour
- Brass plated iron
- Iron weight filling
- Can be used for any clock
- Made in China

Dimensions:

- Overall length x Cylinder diameter Ø

Code	Description	UOM	Price
<b>P47599</b>	1010 x Ø20mm Pendulum	EACH	<b>£12.95</b>



## ENGLISH DIAL PENDULUMS

### Bobs, English Dial (Fusee)



English Dial, Fusee Bracket Clock Pendulum Bobs

- Polished Brass
- Brass Double Sided
- Lead Filled
- Made in the UK

Dimensions:

- Bracket - Ø62mm (2½")
- Fusee (English Dial) - Ø74mm (3")

Code	Description	UOM	Price
<b>P34560</b>	Ø62mm Bracket Bob	EACH	<b>£39.95</b>
<b>P34561</b>	Ø74mm Fusee Bob	EACH	<b>£41.95</b>

### Pendulums, English Dial (Fusee)



Fusee (English Dial) Clock Pendulums

- Polish Brass
- Lead Filled
- Pendulum bob & Rod Complete
- Includes Rating Nut
- Ø74mm Bob
- Sizes shown are the total length of the rods
- Made in UK

Code	Description	UOM	Price
<b>P7621</b>	190mm (7½") Pendulum	EACH	<b>£46.50</b>
<b>P1126</b>	215mm (8½") Pendulum	EACH	<b>£49.95</b>
<b>P1127</b>	240mm (9½") Pendulum	EACH	<b>£51.95</b>
<b>P1128</b>	267mm (10½") Pendulum	EACH	<b>£52.95</b>
<b>P7622</b>	290mm (11½") Pendulum	EACH	<b>£54.95</b>

### Pendulum Flats (Rods) English Dial (Fusee)



Fusee (English Dial) Clock Pendulum Rods

- Brass
- Circular Knurled Rating Nut
- Various Lengths
- Dimensions are Overall Length
- Made in UK

Code	Description	UOM	Price
<b>P34562</b>	140mm (5½") Fusee Rod	EACH	<b>£9.95</b>



**ORDER**  
tracking

**PRICE PROMISE**  
**GUARANTEE** ✓

P34563	165mm (6½") Fusee Rod	EACH	£10.15
P34564	190mm (7½") Fusee Rod	EACH	£10.60
P34565	270mm (10½") Fusee Rod	EACH	£11.95
P34566	295mm (11½") Fusee Rod	EACH	£12.05
P34567	320mm (12½") Fusee Rod	EACH	£12.75
P34624	345mm (13½") Fusee Rod	EACH	£13.25

## GRIDIRON PENDULUMS

Pendulums that are specifically to brand (Hermle) have the dimensions given to enable them to be universally used on any clock.

### Gridiron Pendulums



Pendulums that are specifically to brand (Hermle) have the dimensions given to enable them to be universally used on any clock.

- Gridiron Style Brass rod
- Polished Brass Bob
- Can be used for any clock
- Made in Germany
- Manufactured by Hermle

Dimensions:

- Overall length x bob diameter (Pendulum length stamp on Hermle Movement)\*

\*The Hermle pendulum length is stamped on the back of the movement, next to or underneath the calibre. The "cm" length is measured from the suspension pinning point to bottom of the pendulum tip, including the pendulum leader and suspension spring (supplied separately)

Code	Description	UOM	Price
P9590	280 x Ø80mm (38cm) Hermle Pendulum	EACH	£23.95
P9589	430 x Ø100mm (52cm) Hermle Pendulum	EACH	£37.85
P9588	480 x Ø100mm (55cm) Hermle Pendulum	EACH	£40.50
P9587	590 x Ø115mm (66cm) Hermle Pendulum	EACH	£50.95



## FRENCH CLOCK PENDULUMS

### French Clock Pendulums

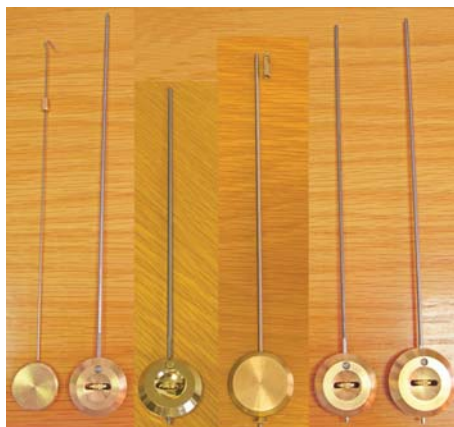

#### French Clock Pendulums

- Brass with Steel rod
- Brass pendulum (0, 1, & 2) with centre regulating nut for French clocks
- Rods are of ample length for shortening as required
- Excludes hook (Part Number F0672)
- High Quality
- Can be manipulated to fit
- Made in UK
- Made in India\*

P1132:

- Total length 24cm
- Bob Ø = 28mm
- Weight = 22grams

Code	Description	UOM	Price
P1132	Ø28mm (Silk) Pendulum	EACH	£7.35
P1129	Ø32mm (No.0) Pendulum	EACH	£10.95
P39708	Ø32mm (No.0) Pendulum*	EACH	£3.50
P39687	Ø35mm (No.1) Pendulum & Hook*	EACH	£5.95
P1130	Ø35mm (No.1) Pendulum	EACH	£10.95
P1131	Ø38mm (No.2) Pendulum	EACH	£11.50

## LONGCASE PENDULUMS & FLATS

### Longcase Bob, Brass

Longcase (L/C) Polished Brass Faced Pendulum Bob

A High Quality Pendulum Bob for Good Quality Longcase 8 day & 30 hour Movements. Cast directly on to the polished brass face with a totally enclosed slot for the pendulum flat, running through the centre of the Bob.

- Ø100mm (4")
- Brass Faced Lead Bob
- One Piece Lead Casting
- Weight 2.75lb (1.278kg) approx.
- Slot 9.50 x 4.75mm (3/8" x 3/16")
- Made in UK

Code	Description	UOM	Price
P34548	Ø100mm (4") L/C Bob, Brass	EACH	£28.95

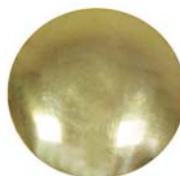

### Longcase Bob, Brass with Slide



#### Longcase Polished Brass Pendulum Bob with Slide

- Polished brass Faced
- Lead Centre
- Steel Pendulum Flat
- Tapped 1/8th for steel rod
- With rating slide and nut
- 30 hour or 8 day available
- Made in UK

Dimensions;

- Ø88mm (3½") for 30 hour
- Ø100mm (4") for 8 Day

Code	Description	UOM	Price
P8963	Ø88mm (3½") 30 hour	EACH	£27.95
P8964	Ø100mm (4") 8 Day	EACH	£31.50

### Longcase Bob, Cast Iron



#### Longcase Cast Iron Pendulum Bob with Slide

- Cast Iron Bob
- High Quality
- Ø100mm (4") Approximate
- Decorative Cast Front
- Completely Enclosed Slot on the Rear
- Supplied with Flat & Rating Nut

Code	Description	UOM	Price
P34547	Ø100mm (4") L/C Bob with Slide (Part Pattern)	EACH	£28.95
P34547A	Ø100mm (4") L/C Bob with Slide (Full Pattern)	EACH	£28.95

### Longcase Bob, Lead

#### Longcase Lead Pendulum Bob

- Lead (Plain)
- Weight 1.2kg
- Ø100mm
- Fits our standard steel & brass pendulum flats & rods
- Manufactured for basic country clocks
- Made in UK



Code	Description	UOM	Price
P34657	Ø100mm (4") L/C Bob	EACH	£22.95



Longcase Pendulum Flats & Nuts

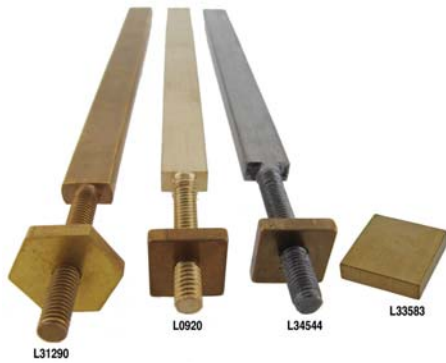

Long Case Clock - Pendulum Flats & Nuts

Brass Pendulum Flat & adjusting nut. 3/8" x 3/16" Drilled & threaded to take the pendulum rod 1/8" Witworth .

- Tapped to take 1/8th Witworth Pendulum Rod
- 160mm overall Length
- 9.75mm x 5.00mm Section

Types:

- Brass Flat with Hexagonal Nut
- Brass Flat with Square Nut
- Steel Flat with Square Nut

Code	Description	UOM	Price
L31290	Brass Flat with Hexagonal Nut	EACH	£3.95
L0920	Brass Flat with Square Nut	EACH	£6.10
L34544	Steel Flat with Square Nut	EACH	£5.15
L33583	Rating Nut, Blind	EACH	£1.15

Longcase Rods, Steel

Longcase Steel Pendulum Rods

- Longcase Steel Pendulum Rods
- Threaded Both Ends, 1/8" Witworth
- 1/8" Diameter Rod
- Made in UK



Code	Description	UOM	Price
P9741	32" Steel Pendulum Rod	EACH	£2.95
P34556	33" Steel Pendulum Rod	EACH	£2.90
P1140	34" Steel Pendulum Rod	EACH	£2.90

Price breaks available, see website

Longcase Rods, Wooden

Longcase Pendulum Rods, Wooden

Pre-sanded wood, smooth, ready to be varnished & stained.

- Elliptical Shape Rods
- With non threaded end
- Generic
- For fittings see code P8255
- Made in Germany



Code	Description	UOM	Price
P8253	Pendulum Rod 950mm, Width 19mm x 6mm	EACH	£11.95

P8254	Pendulum Rod 950mm, Width 25mm x 7mm	EACH	£14.95
-------	--------------------------------------	------	--------

LYRE PENDULUMS

Pendulums that are specifically to brand (Hermle) have the dimensions given to enable them to be universally used on any clock.

Lyre, Hermle



Pendulums that are specifically to brand (Hermle) have the dimensions given to enable them to be universally used on any clock.

- Various bob sizes
- Various lengths
- Gridiron Style Brass rod
- Polished Brass Bob
- Lyre style
- Can be used for any clock
- Made in Germany
- Manufactured by Hermle

Dimensions:

- Overall length x bob diameter (Pendulum length stamp on Hermle Movement)\*

\*The Hermle pendulum length is stamped on the back of the movement, next to or underneath the calibre. The "cm" length is measured from the suspension pinning point to bottom of the pendulum tip, including the pendulum leader and suspension spring (supplied separately)

Code	Description	UOM	Price
P9586	330 x Ø100mm (45cm) Hermle Pendulum	EACH	£39.95
P9585	460 x Ø100mm (55cm) Hermle Pendulum	EACH	£39.95
P9584	560 x Ø100mm (66cm) Hermle Pendulum	EACH	£39.95
P42039	660 x Ø100mm (75cm) Hermle Pendulum	EACH	£39.95
P42038	660 x Ø115mm (75cm) Hermle Pendulum	EACH	£39.95
P42037	680 x Ø180mm (75cm) Hermle Pendulum	EACH	£39.95
P42091	770 x Ø165mm (85cm) Hermle Pendulum	EACH	£49.95
P42090	890 x Ø165mm (94cm) Hermle Pendulum	EACH	£69.95
P42086	910 x Ø270mm (94cm) Hermle Pendulum	EACH	£69.95
P42088	945 x Ø220mm (94cm) Hermle Pendulum	EACH	£69.95
P42089	1080 x Ø165mm (114cm) Hermle Pendulum	EACH	£69.95
P42087	1090 x Ø220mm (114cm) Hermle Pendulum	EACH	£69.95
P42085	1100 x Ø270mm (114cm) Hermle Pendulum	EACH	£69.95

Lyre (Luxury)



Pendulums that are specifically to brand (Hermle) have the dimensions given to enable them to be universally used on any clock.

- Ø220 or Ø270mm bob
- 1030mm overall length
- Gridiron Style
- Polished brass colour bob with "Lyre" style
- Stainless steel plated titanium
- Can be used for any clock
- Made in South Korea

Dimensions:

- Overall length x bob diameter

Code	Description	UOM	Price
P47598	Ø220 x 1030mm Pendulum	EACH	£39.95
P47597	Ø270 x 1030mm Pendulum	EACH	£45.95

Lyre (Luxury)



Pendulums that are specifically to brand (Hermle) have the dimensions given to enable them to be universally used on any clock.

- Ø180mm bob
- 950mm overall length
- Gridiron Style
- Polished brass colour bob with "Lyre" style
- Stainless steel plated titanium
- Can be used for any clock
- Made in South Korea

Dimensions:

- Overall length x bob diameter

Code	Description	UOM	Price
P48053	950 x Ø180mm Pendulum	EACH	£12.95

**Lyre (Luxury)**



Pendulums that are specifically to brand (Hermle) have the dimensions given to enable them to be universally used on any clock.

- Ø220mm bob
- 1050mm overall length
- Gridiron Style
- Beautifully etched polished brass colour bob
- Lyre style
- Stainless steel plated titanium
- Can be used for any clock
- Made in South Korea

Dimensions:

- Overall length x bob diameter

Code	Description	UOM	Price
P48937	Ø220 x 1050mm Pendulum	EACH	£39.95

**Lyre (Luxury)**



Pendulums that are specifically to brand (Hermle) have the dimensions given to enable them to be universally used on any clock.

- Ø220mm bob
- 1050mm overall length
- Gridiron Style
- Polished brass colour bob with cast brass applique
- Lyre style
- Stainless steel plated titanium
- Can be used for any clock
- Made in South Korea

Dimensions:

- Overall length x bob diameter

Code	Description	UOM	Price
P48938	Ø220 x 1050mm Pendulum	EACH	£41.95

**Lyre (Luxury), Hermle**

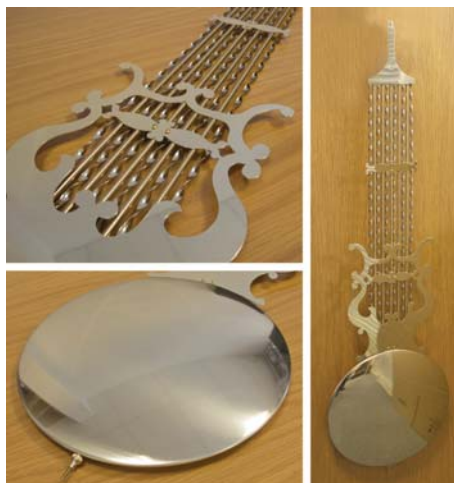

Pendulums that are specifically to brand (Hermle) have the dimensions given to enable them to be universally used on any clock.

- Ø270mm bob
- 930 or 1120mm overall length
- Gridiron Style
- Polished brass bob with "Lyre" style
- Can be used for any clock
- Made in Germany
- Manufactured by Hermle

Dimensions:

- Overall length x bob diameter (Pendulum length stamp on Hermle Movement)\*

\*The Hermle pendulum length is stamped on the back of the movement, next to or underneath the calibre. The "cm" length is measured from the suspension pinning point to bottom of the pendulum tip, including the pendulum leader and suspension spring (supplied separately)

Code	Description	UOM	Price
P42070	930 x Ø270mm (94cm) Hermle Pendulum	EACH	£95.95
P42069	1120 x Ø270mm (114cm) Hermle Pendulum	EACH	£95.95

**Lyre (Luxury), Hermle**

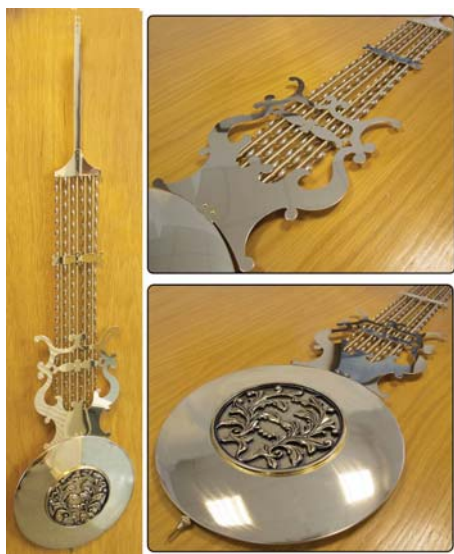

Pendulums that are specifically to brand (Hermle) have the dimensions given to enable them to be universally used on any clock.

- Ø270mm bob
- 1120mm overall length
- Polished brass bob with "Lyre" style
- Can be used for any clock
- Made in Germany
- Manufactured by Hermle

Dimensions:

- Overall length x bob diameter (Pendulum length stamp on Hermle Movement)\*

\*The Hermle pendulum length is stamped on the back of the movement, next to or underneath the calibre. The "cm" length is measured from the suspension pinning point to bottom of the pendulum tip, including the pendulum leader and suspension spring (supplied separately)

Code	Description	UOM	Price
P42076	1120 x Ø270mm (114cm) Hermle Pendulum	EACH	£84.95

**Lyre (Luxury), Hermle**



Pendulums that are specifically to brand (Hermle) have the dimensions given to enable them to be universally used on any clock.

- Ø270mm bob
- 1120mm overall length
- Gridiron Style
- Polished brass bob with "Lyre" style
- Can be used for any clock
- Made in Germany
- Manufactured by Hermle

Dimensions:

- Overall length x bob diameter (Pendulum length stamp on Hermle Movement)\*

\*The Hermle pendulum length is stamped on the back of the movement, next to or underneath the calibre. The "cm" length is measured from the suspension pinning point to bottom of the pendulum tip, including the pendulum leader and suspension spring (supplied separately)

Code	Description	UOM	Price
P42078	1120 x Ø270mm (114cm) Hermle Pendulum	EACH	£95.95

**Cotton Gloves**



Ref: G5324 See Page: 817

**Lyre (Luxury), Hermle**



Pendulums that are specifically to brand (Hermle) have the dimensions given to enable them to be universally used on any clock.

- Ø270mm bob
- 1120mm overall length
- Gridiron Style
- Polished brass bob with "Lyre" style
- Can be used for any clock
- Made in Germany
- Manufactured by Hermle

Dimensions:

- Overall length x bob diameter (Pendulum length stamp on Hermle Movement)\*

\*The Hermle pendulum length is stamped on the back of the movement, next to or underneath the calibre. The "cm" length is measured from the suspension pinning point to bottom of the pendulum tip, including the pendulum leader and suspension spring (supplied separately)

Code	Description	UOM	Price
P42081	1120 x Ø270mm (114cm) Hermle Pendulum	EACH	£95.95

**Lyre (Luxury), Hermle**

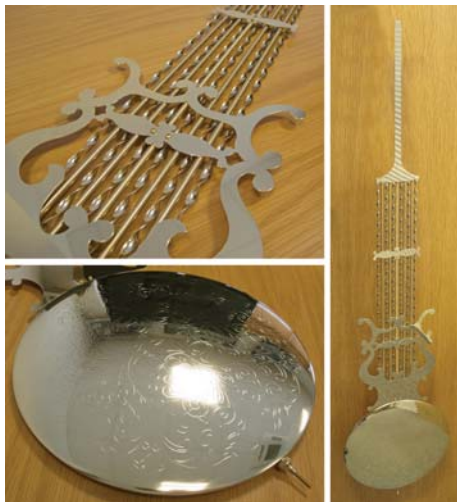

Pendulums that are specifically to brand (Hermle) have the dimensions given to enable them to be universally used on any clock.

- Ø270mm bob
- 1120mm overall length
- Gridiron Style
- Polished brass bob with "Lyre" style
- Can be used for any clock
- Made in Germany
- Manufactured by Hermle

Dimensions:

- Overall length x bob diameter (Pendulum length stamp on Hermle Movement)\*

\*The Hermle pendulum length is stamped on the back of the movement, next to or underneath the calibre. The "cm" length is measured from the suspension pinning point to bottom of the pendulum tip, including the pendulum leader and suspension spring (supplied separately)

Code	Description	UOM	Price
P42072	1120 x Ø270mm (114cm) Hermle Pendulum	EACH	£95.95

**Lyre (Luxury), Hermle**

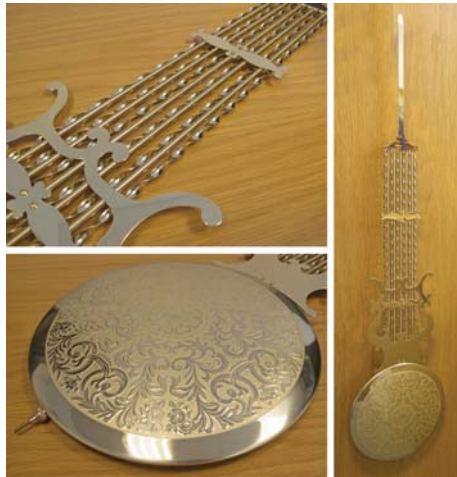

Pendulums that are specifically to brand (Hermle) have the dimensions given to enable them to be universally used on any clock.

- Ø270mm bob
- 1120mm overall length
- Gridiron Style
- Polished brass bob with "Lyre" style
- Can be used for any clock
- Made in Germany
- Manufactured by Hermle

Dimensions:

- Overall length x bob diameter (Pendulum length stamp on Hermle Movement)\*

\*The Hermle pendulum length is stamped on the back of the movement, next to or underneath the calibre. The "cm" length is measured from the suspension pinning point to bottom of the pendulum tip, including the pendulum leader and suspension spring (supplied separately)

Code	Description	UOM	Price
P42073	1120 x Ø270mm (114cm) Hermle Pendulum	EACH	£95.95

**Lyre (Luxury), Hermle**



Pendulums that are specifically to brand (Hermle) have the dimensions given to enable them to be universally used on any clock.

the dimensions given to enable them to be universally used on any clock.

- Ø270mm bob
- 1120mm overall length
- Gridiron Style
- Polished brass bob with "Lyre" style
- Can be used for any clock
- Made in Germany
- Manufactured by Hermle

Dimensions:

- Overall length x bob diameter (Pendulum length stamp on Hermle Movement)\*

\*The Hermle pendulum length is stamped on the back of the movement, next to or underneath the calibre. The "cm" length is measured from the suspension pinning point to bottom of the pendulum tip, including the pendulum leader and suspension spring (supplied separately)

Code	Description	UOM	Price
P42074	1120 x Ø270mm (114cm) Hermle Pendulum	EACH	£95.95

**Lyre (Luxury), Hermle**



Pendulums that are specifically to brand (Hermle) have the dimensions given to enable them to be universally used on any clock.

- Ø270mm bob
- 1120mm overall length
- Gridiron Style
- Polished brass bob with "Lyre" style
- Can be used for any clock
- Made in Germany
- Manufactured by Hermle

Dimensions:

- Overall length x bob diameter (Pendulum length stamp on Hermle Movement)\*

\*The Hermle pendulum length is stamped on the back of the movement, next to or underneath the calibre. The "cm" length is measured from the suspension pinning point to bottom of the pendulum tip, including the pendulum leader and suspension spring (supplied separately)

Code	Description	UOM	Price
P42075	1120 x Ø270mm (114cm) Hermle Pendulum	EACH	£95.95





**Lyre (Luxury), Hermle**



Pendulums that are specifically to brand (Hermle) have the dimensions given to enable them to be universally used on any clock.

- Ø270mm bob
- 1120mm overall length
- Gridiron Style
- Polished brass bob with "Lyre" style
- Can be used for any clock
- Made in Germany
- Manufactured by Hermle

Dimensions:

- Overall length x bob diameter (Pendulum length stamp on Hermle Movement)\*

\*The Hermle pendulum length is stamped on the back of the movement, next to or underneath the calibre. The "cm" length is measured from the suspension pinning point to bottom of the pendulum tip, including the pendulum leader and suspension spring (supplied separately)

Code	Description	UOM	Price
P42077	1120 x Ø270mm (114cm) Hermle Pendulum	EACH	£95.95

**MANTLE CLOCK PENDULUMS**

**Mantle Clock Pendulums**



Mantle Clock Pendulums

- Includes bob, threaded rod, hook, regulating nut & spring
- Bob diameter: Ø40mm
- Maximum length: 65mm
- Minimum length: 50mm
- Weight: 50g
- Brass and stainless steel

- Spring loaded bob, ensures the bob remains at the end of the rod
- Made in China

Dimensions:

- Colour, bob diameter Ø x maximum length

Code	Description	UOM	Price
P47683	Brass, Ø40mm x 65mm	EACH	£8.95
P47684	Stainless Steel, Ø40mm x 65mm	EACH	£8.95

**R&A PENDULUMS**

Pendulums that are specifically to brand (Hermle) have the dimensions given to enable them to be universally used on any clock.

**R&A Gridiron (2 Rod), Hermle**



Pendulums that are specifically to brand (Hermle) have the dimensions given to enable them to be universally used on any clock.

- Gridiron Style, 2 Brass rods
- Polished Brass Bob with R&A Plaque
- Can be used for any clock
- Made in Germany
- Manufactured by Hermle

Dimensions:

- Overall length x bob diameter (Pendulum length stamp on Hermle Movement)\*

\*The Hermle pendulum length is stamped on the back of the movement, next to or underneath the calibre. The "cm" length is measured from the suspension pinning point to bottom of the pendulum tip, including the pendulum leader and suspension spring (supplied separately)

Code	Description	UOM	Price
P1141	145 x Ø63mm (21cm) Hermle Pendulum	EACH	£15.95
P19808	165 x Ø63mm (25cm) Hermle Pendulum	EACH	£18.95
P1142	240 x Ø63mm (38cm) Hermle Pendulum	EACH	£27.85

**R&A Gridiron (4 Rod), Hermle**



Pendulums that are specifically to brand (Hermle) have the dimensions given to enable them to be universally used on any clock.

- Gridiron Style, 4 Brass rods
- Polished Brass Bob with R&A Plaque
- Can be used for any clock
- Made in Germany
- Manufactured by Hermle

Dimensions:

- Overall length x bob diameter (Pendulum length stamp on Hermle Movement)\*

\*The Hermle pendulum length is stamped on the back of the movement, next to or underneath the calibre. The "cm" length is measured from the suspension pinning point to bottom of the pendulum tip, including the pendulum leader and suspension spring (supplied separately)

Code	Description	UOM	Price
P42040	240 x Ø80mm (34cm) Hermle Pendulum	EACH	£19.95
P47034	250 x Ø80mm (35cm) Hermle Pendulum	EACH	£19.95
P42041	255 x Ø80mm (38cm) Hermle Pendulum	EACH	£19.95
P9591	300 x Ø80mm (43cm) Hermle Pendulum	EACH	£19.95
P9592	300 x Ø80mm (45cm) Hermle Pendulum	EACH	£19.95
P9593	360 x Ø80mm (48cm) Hermle Pendulum	EACH	£21.95
P42042	480 x Ø80mm (55cm) Hermle Pendulum	EACH	£22.95

**PRICE PROMISE GUARANTEE**

**CUSTOMER SERVICE SECOND TO NONE**

**Contact & Services**

**Your direct line to our Management Team**

*All correspondence is time stamped and answered within 1 hour of receipt*  
**Instant Message Service**

## REGULAR PENDULUMS & RODS (UNIVERSAL & HERMLE)

Pendulums that are specifically to brand (Hermle) have the dimensions given to enable them to be universally used on any clock.

### Bobs for Wooden Pendulum Rods

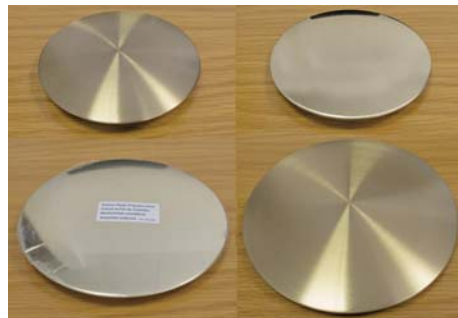

Pendulums & Bobs that are specifically to brand (Hermle) have the dimensions given to enable them to be universally used on any clock.

Manufactured by Hermle

- Polished & Spun brass
- For use with wooden pendulum rods
- Various diameters
- Made in Germany

Code	Description	UOM	Price
B46105	Ø80mm Bob, Polished Brass	EACH	£14.95
B46106	Ø100mm Bob, Polished Brass	EACH	£15.95
P8296	Ø115mm Bob, Polished Brass	EACH	£16.25
P37689	Ø115mm Bob, Spun Brass	EACH	£16.95
P38200	Ø140mm Bob, Polished Brass	EACH	£22.95
P8297	Bob Ø140mm, Spun Brass	EACH	£22.95
B46109	Ø165mm Bob, Polished Brass	EACH	£19.95

### Pendulums, Regular



Pendulums & Bobs that are specifically to brand (Hermle) have the dimensions given to enable them to be universally used on any clock.

- Brass rod and bob
- Polished brass bob
- Can be used for any clock
- Smaller models excellent for Napoleon clocks
- Made in Germany
- Manufactured by Hermle

Dimensions:

- Overall length x bob diameter (Pendulum length stamped on Hermle Movement)\*

\*The Hermle pendulum length is stamped on the back of the movement, next to or underneath the calibre. The "cm" length is measured from the suspension pinning point to bottom of the pendulum tip, including

the pendulum leader and suspension spring (supplied separately)

Code	Description	UOM	Price
P42043	55 x Ø37mm (11cm) Hermle Pendulum	EACH	£14.95
P8796	85 x Ø42mm Hermle Pendulum	EACH	£14.95
P42046	90 x Ø48mm (21cm) Hermle Pendulum	EACH	£14.95
P42045	95 x Ø55mm (21cm) Hermle Pendulum	EACH	£14.95
P42044	115 x Ø43mm (18cm) Hermle Pendulum	EACH	£14.95
P42047	115 x Ø48mm (23cm) Hermle Pendulum	EACH	£14.95
P42048	130 x Ø43mm (25cm) Hermle Pendulum	EACH	£14.95
P42051	220 x Ø70mm (34cm) Hermle Pendulum	EACH	£21.95
P42052	230 x Ø40mm (38cm) Hermle Pendulum	EACH	£21.95
P42053	285 x Ø40mm (43cm) Hermle Pendulum	EACH	£18.95
HERB021016104	310 x Ø80mm (45cm) Hermle Pendulum	EACH	£18.95
P42055	430 x Ø80mm (55cm) Hermle Pendulum	EACH	£18.95
P42057	615 x Ø80mm (75cm) Hermle Pendulum	EACH	£18.95
P42058	700 x Ø90mm (85cm) Hermle Pendulum	EACH	£18.95
P42056	710 x Ø80mm (66cm) Hermle Pendulum	EACH	£18.95
P42059	830 x Ø90mm (94cm) Hermle Pendulum	EACH	£18.95

### Hermle Rods, Wooden



Pendulums Rods that are specifically to brand (Hermle) have the dimensions given to enable them to be universally used on any clock.

Manufactured by Hermle

- Pre-sanded wood, smooth, ready to be varnished & stained.
- Elliptical Shape Rods
- Supplied with fittings
- Can be shortened to requirement
- Unfinished, can be stained to match clock case
- Made in Germany

Dimensions:

- Rod Length\* x rod width

\*Rod length does not include brass hanger and threaded pin

Code	Description	UOM	Price
P42062	345 x 20mm	EACH	£8.95
H38800	520 x 18mm	EACH	£14.95
P42060	560 x 20mm	EACH	£14.95
H38221	600 x 20mm	EACH	£14.95
H38221A	615 x 20mm	EACH	£14.95
P42061	725 x 20mm	EACH	£14.95
P42068	750 x 20mm	EACH	£14.95
H38194	770 x 20mm	EACH	£16.95
P42063	935 x 20mm	EACH	£19.95
H38203	935 x 25mm	EACH	£19.95
H38199	940 x 25mm	EACH	£19.95



WORLDWIDE DELIVERY

### Universal Rod

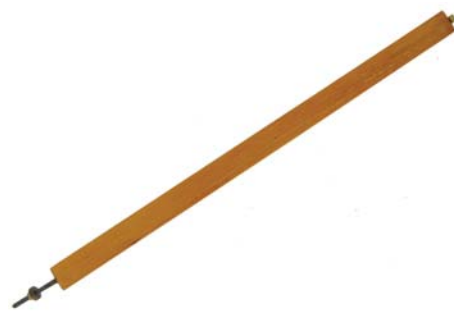

- Overall Length 350mm (14")
- Width 16mm
- With thread & brass rating nut & hook

Code	Description	UOM	Price
P32021	Pendulum Rod, Wooden (14")	EACH	£3.15

### Longcase Rod (wooden) Fittings

Longcase Wood Pendulum Rod Fittings



Made up of two hooks, rating nut, metal rod plus fixings etc.

- Longcase Clock
- For Elliptical Shape Rods
- To suit P8253 & P8254
- Metal rod length 130mm
- Made in Germany

Code	Description	UOM	Price
P8255	Long Case Wood Pendulum Rod Fittings	EACH	£19.95

## SESSIONS & SUNBURST BOBS

### Sessions & Sunburst Bobs

Sessions Bob

- 55gms
- Brass
- Overall Height: 40mm



Sunburst Bob

- Ø50mm
- With rear guides for rods of approx Ø2.00 to 3.50mm
- Antique brass finish
- Approx weight 35 grams.

Code	Description	UOM	Price
E32049	Sessions Clock Brass Pendulum	EACH	£4.85
P8767	Sunburst Bob	EACH	£11.75



COUSINSUK  
A WEALTH OF INFORMATION



Online Discounts

## SETH THOMAS PENDULUMS

### Seth Thomas Pendulum Rod

Seth Thomas Pendulum Rod & Suspension Spring

- P32024:  
• Overall Length 300mm
- S32022:  
• Overall Length 350mm



Code	Description	UOM	Price
P32024	300mm (length) Seth Thomas	EACH	£2.30
S32022	350mm (length) Seth Thomas	EACH	£3.15

## UNIVERSAL PENDULUMS

### Pendulums (Universal)



Universal Pendulum, can be shortened to fit all types of clocks

- Brass bob Ø35mm
- Teel Rod Length 170mm

Code	Description	UOM	Price
P31287	170 x Ø35mm Pendulum Rod and Bob	EACH	£4.95

## UNIVERSAL PENDULUM HOOKS

### Pendulum Hook (28 x 8mm)

Pendulum Hook

- 22 x 8mm (Overall height x width)
- Single hook, bend to shape
- Brass finish aluminium



Code	Description	UOM	Price
P47686	Pendulum Hook	EACH	£0.95

### Pendulum Hook (32 x 5mm)

Pendulum Hook

- 32 x 5mm (Overall height x width)
- 2.5mm bottom hole
- Brass finish aluminium
- Can be adapted to suit



Code	Description	UOM	Price
P47687	Pendulum Hook	EACH	£0.95

### Pendulum Hooks (32 x 8mm)

Pendulum Hook

- 32 x 8mm (Overall height x width)
- 2.25mm bottom hole
- Single hook
- Brass finish aluminium



Code	Description	UOM	Price
P46068	Pendulum Hook	EACH	£0.95

### Pendulum Hook (40 x 16mm)

Pendulum Hook

- 40 x 16mm (Overall height x width)
- Max rod diameter 15mm
- Single hook
- Brass finish aluminium



Code	Description	UOM	Price
P47685	Pendulum Hook	EACH	£0.95

### Pendulum Hook (40 x 20mm)

Pendulum Hook

- 40 x 20mm (Overall height x width)
- Max rod diameter 19mm
- Single hook
- Brass finish aluminium



Code	Description	UOM	Price
P46067	Pendulum Hook	EACH	£0.85

### Pendulum Hook, Double Hook (45 x 30mm)

Pendulum Hook

- 45 x 30mm (Overall height x width)
- Pilot holes 15mm apart
- Double hook
- Brass finish aluminium



Code	Description	UOM	Price
P46069	Pendulum Hook, Double Hook	EACH	£1.50

### Pendulum Hook, French Clock (4 x 4mm)

French Clock - Pendulum Hook

Pendulum hook for French clocks, manufactured from 4mm square brass with a pilot hole drilled into the base. We recommend the use of a 7BA thread for fitting.



- Brass
- 4mm Square
- With pilot bore hole for pendulum rod
- Made in UK

Code	Description	UOM	Price
P39688	French Clock Pendulum Hook	EACH	£0.95
F0672	French Clock - Pendulum Hook	EACH	£1.45

### Pendulum Hook, Threaded End (25 x 4mm)



Pendulum Rod Hooks with Threaded End

- Solid brass
- With threaded end for wooden pendulum rods
- Dimensions: 4 x 4 x 25 mm
- Slotted
- 6 pieces

Code	Description	UOM	Price
H7789	Pendulum Rod Hooks with Threaded End	PACK*6	£26.50

### Pendulum Hook, Threaded Hole (17.5 x 4mm)

Pendulum Rod Hooks with Threaded Hole

- Solid brass
- Dimensions: 4 x 4 x 17.5mm
- Slotted
- Diameter: Ø2.5mm hole
- Made in Germany



Code	Description	UOM	Price
H7790	Pendulum Rod Hooks with Threaded Hole	EACH	£5.95

PRICE PROMISE  
GUARANTEE

**ORDER tracking**

**TODAY SAME DAY DISPATCH**

**Compressed Air Cleaner**

Ref: A38766  
See Page: 776

**UNIVERSAL REGULATING NUTS**

**Regulating Nuts (Universal)**

Pendulum Regulating Nuts

- Brass
- For Pendulum clocks
- 5 Nuts & 5 Guide Pieces
- Pack of 10
- Made in Germany or India

Hermle Pendulum Nut (Pendelmutter) E007.05290:

- Hermle 451.050 (65)
- Hermle 451.053 (65)
- Hermle 451.053H (65)
- Hermle 461.050 (65)
- Hermle 1151.050 (69)
- Hermle 1161.050 (67)

Calibre x (Hermle PDF Part Number)

**Pendulum Regulating Nuts**



- Brass
- For Pendulum clocks
- 5 Nuts & 5 Guide Pieces
- 3 Different Sizes
- Pack of 10

Code	Description	UOM	Price
P45748	Pendulum Regulating Nuts	PACK*10	£4.95

**Pendulum Regulating Nuts, Made in Germany**



- Brass
- For Pendulum clocks
- 5 Nuts & 5 Guide Pieces
- 3 Different Sizes
- Pack of 10

Code	Description	UOM	Price
P1139	Pendulum Regulating Nuts, Made in Germany	PACK*10	£25.95

**E007.05290 Hermle Pendulum Nut**

Hermle Pendulum Nut (Pendelmutter)

E007.05290:

- Hermle 451.050 (65)
- Hermle 451.053 (65)
- Hermle 451.053H (650)
- Hermle 461.050 (65)
- Hermle 1151.050 (69)
- Hermle 1161.050 (67)

Calibre x (Hermle PDF Part Number)



Code	Description	UOM	Price
HERE00705290K4	E007.05290 Hermle Pendulum Nut	EACH	£2.20

**PENDULUMS (QUARTZ) & PENDULUM PARTS**

**PENDULUMS (QUARTZ)**

*Pendulums that are specifically brand (Hermle) have the dimensions given to enable them to be universally used on any clock.*

*Got a quartz clock with a missing pendulum? Replace it here, the largest range of quartz clock pendulums, bobs & rods. With pendulums from brands such as Hermle & UTS as well as a large selection of unbranded pendulums, you will find what you are looking for here*

- Brass
- Bronze
- Cylinder
- Patterned
- Lyre
- Ornamental
- Plastic
- R&A
- R&A Gridiron
- Steel

**Cylinder Brass Aluminium, Chinese**

Cylinder Pendulums

- Rod & Cylinder
- For quartz clock movements
- Rod can be shortened to suit your requirement
- Brass colour
- Made from aluminium
- Made in China

Dimensions

- Overall length x Cylinder diameter Ø



Code	Description	UOM	Price
P47601	580 x Ø20mm Cylinder Pendulum	EACH	£9.95

**Cylinder (Double) Brass Aluminium, Chinese**

Cylinder Pendulums

- Rod & 2 Cylinders
- For quartz clock movements
- Overall width of 2 cylinder bob Ø65mm
- Rod can be shortened to suit your requirement
- Brass colour
- Made from aluminium
- Made in China



Dimensions

- Overall length x Cylinder diameter Ø

Code	Description	UOM	Price
P47600	910 x Ø20mm Pendulum	EACH	£12.95

**Windles Clock Oil**

See Page 1183

**Lyre Brass Aluminium, Chinese**



Lyre Pendulums - Steel

- Lyre Style
- For quartz clock movements
- Brass colour
- Made from aluminium
- Made in China

Dimensions: Bob Diameter x Overall Length

Code	Description	UOM	Price
P48059	Ø60 x 210mm Lyre Brass Pendulum	EACH	£2.95
P48060	Ø70 x 245mm Lyre Brass Pendulum	EACH	£2.95
P48061	Ø80 x 260mm Lyre Brass Pendulum	EACH	£3.25
P48062	Ø88 x 260mm Lyre Brass Pendulum	EACH	£3.50

**Lyre Brass Aluminium, Chinese**

Lyre Pendulums - Steel

- Lyre Style
- For quartz clock movements
- Brass colour
- Made from aluminium
- Made in China

Dimensions: Bob Diameter x Overall Length



Code	Description	UOM	Price
P48054	Ø115 x 380mm Lyre Brass Pendulum	EACH	£7.95

**Lyre Steel Aluminium, Chinese**

Lyre Pendulums - Steel

- Lyre Style
- For quartz clock movements
- Steel colour
- Made from aluminium
- Made in China

Dimensions: Bob Diameter x Overall Length



Code	Description	UOM	Price
P46015	Ø60 x 215mm Lyre SS Pendulum	EACH	£4.95
P46016	Ø70 x 215mm Lyre SS Pendulum	EACH	£4.95
P46017	Ø80 x 215mm Lyre SS Pendulum	EACH	£4.95
P46018	Ø88 x 215mm Lyre SS Pendulum	EACH	£4.95

**Novelty Brass, Indian**

Novelty Clock Button Pendulum - Brass

- Brass
- 64mm Total Length
- Ø17mm Brass Bob

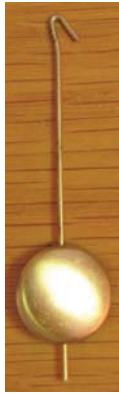

Code	Description	UOM	Price
P1125	Ø17mm Novelty Pendulum	EACH	£2.95

**Ornamental Brass, Indian**

Ornamental Pendulum & Rod

- Weight 110gms
- Brass
- Rating Nut
- Overall Length 160mm



Code	Description	UOM	Price
E32042	Ornamental Pendulum & Rod	EACH	£7.25

**Ornamental Plastic, Indian**



Pendulums - Plastic, Gold Anodised

- Generic plastic pendulums
- Great value
- Anodized gold surface

Model A Length = 280mm  
 Model B Length = 240mm  
 Model C Length = 165mm  
 Model D Length = 90mm

Code	Description	UOM	Price
P37838	Pendulum, Model A	EACH	£1.95
P37839	Pendulum, Model B	EACH	£1.95
P37840	Pendulum, Model C	EACH	£1.95
P37841	Pendulum, Model D	EACH	£1.95

**R&A Brass, Hermle**

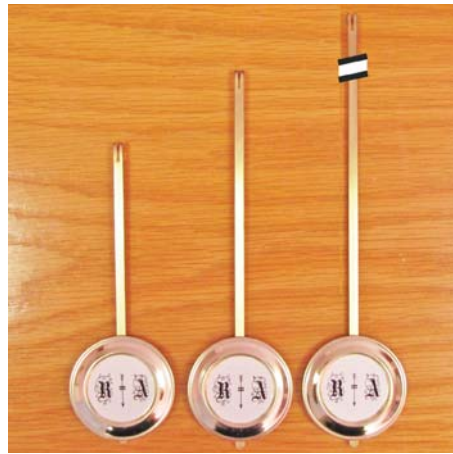

Wall Clock Pendulum - Brass with Plain Rod

Brass, plain rod and polished brass face with R&A Plaque.

- Plain Style
- Polished Brass Bob with R&A Plaque
- For quartz clock movements
- Made in Germany

Dimensions: Bob Diameter x Rod Length

Pendulums manufactured by Hermle Germany. Will fit any quartz clock movement (may need adapting to fit)

Code	Description	UOM	Price
P9594	Ø55mm x 140mm Pendulum	EACH	£9.95
P9595	Ø55mm x 200mm Pendulum	EACH	£11.95
P9596	Ø55mm x 360mm Pendulum	EACH	£11.95
P46104	Ø80mm Bob only, R&A	EACH	£8.95

**R&A (Gridiron) Brass Aluminium, Chinese**

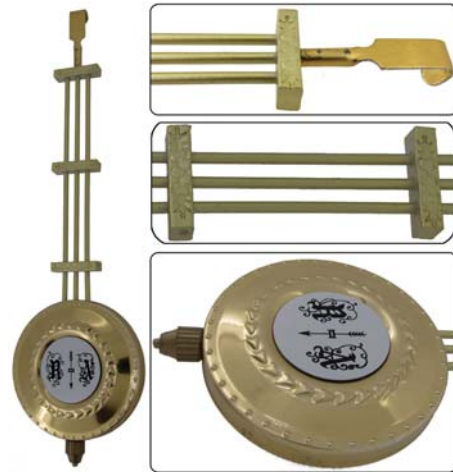

Brass with gridiron type rod and polished brass face with R&A Plaque.

- Gridiron Style (3 rod)
- Polished brass bob with R&A Plaque
- For quartz clock movements
- Brass colour
- Made from aluminium
- Made in China

Dimensions: Bob Diameter x Overall Length

Code	Description	UOM	Price
P48952	Ø55 x 200mm Pendulum	EACH	£4.95

**R&A (Gridiron) Brass Aluminium, Chinese**

Brass with gridiron type rod and polished brass face with R&A Plaque.

- Gridiron Style (5 rod)
- Polished brass bob with R&A Plaque
- For quartz clock movements
- Brass colour
- Made from aluminium
- Made in China



Dimensions: Bob Diameter x Overall Length

Code	Description	UOM	Price
P46007	Ø60 x 200mm R&A Brass Pendulum	EACH	£4.95
P46008	Ø88 x 200mm R&A Brass Pendulum	EACH	£4.95

**R&A (Gridiron) Brass Aluminium, Chinese**



Brass with gridiron type rod and polished brass face with R&A Plaque.

- Gridiron Style (5 rod)
- Polished brass bob with R&A Plaque
- For quartz clock movements
- Brass colour
- Made from aluminium
- Made in China

Dimensions: Bob Diameter x Overall Length

Code	Description	UOM	Price
P48953	Ø55 x 230mm Pendulum	EACH	£5.50

**Clock Suspensions - Assorted**

See Page 1357



**Weight Hooks**

See Page 1371



**R&A (Gridiron) Brass, Hermle**

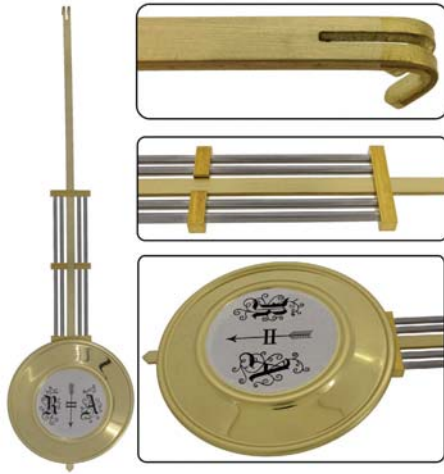

Gridiron Wall Clock Pendulum - Brass with R&A Plaque - Hermle

Brass with gridiron type rod and polished brass face with R&A Plaque.

- Gridiron Style
- Polished Brass Bob with R&A Plaque
- For quartz clock movements
- Made in Germany

Dimensions: Bob Diameter x Rod Length

Pendulums manufactured by Hermle Germany. Will fit any quartz clock movement (may need adapting to fit)

Code	Description	UOM	Price
P42163	Ø80mm x 200mm	EACH	£24.95
P42164	Ø80mm x 300mm	EACH	£24.95
P42165	Ø80mm x 460mm	EACH	£24.95

**R&A (Gridiron) Steel Aluminium, Chinese**

Steel with gridiron type rod and polished brass face with R&A Plaque.

- Gridiron Style
- Polished steel bob with R&A Plaque
- For quartz clock movements
- Steel colour
- Made from aluminium
- Made in China



Dimensions: Bob Diameter x Overall Length

Code	Description	UOM	Price
P46009	Ø60 x 200mm R&A SS Pendulum	EACH	£4.95
P46010	Ø88 x 240mm R&A SS Pendulum	EACH	£4.95

**Regular Antique Aluminium Patterned, Chinese**



Bronze Pendulums

- Rod & bob
- Rods can be shortened to requirement
- Antique style
- Made from aluminium
- For quartz clock movements
- Made in China

Dimensions

• Bob diameter Ø x overall length

See website additional images for pattern close up

Code	Description	UOM	Price
P48951	Ø110 x 235mm Pendulum	EACH	£4.95

**Regular Brass Aluminium, Chinese**

Brass Pendulums

- Rod & bob
- Rods can be shortened to requirement
- Polished brass colour
- Made from aluminium
- For quartz clock movements
- Made in China

Dimensions

• Bob diameter Ø x overall length

Code	Description	UOM	Price
P46011	Ø60 x 170mm Brass Pendulum	EACH	£4.95
P46012	Ø70 x 170mm Brass Pendulum	EACH	£4.95
P46013	Ø80 x 170mm Brass Pendulum	EACH	£4.95
P46014	Ø88 x 170mm Brass Pendulum	EACH	£4.95

**Regular Brass Aluminium Anchor, Chinese**



Patterned Pendulums - Brass Aluminium

- Anchor on the bob

- For quartz clock movements
- Brass colour
- Made from aluminium
- Made in China

Dimensions: Bob Diameter x Overall Length

Code	Description	UOM	Price
P48949	Ø75 x 175mm Pendulum	EACH	£4.95
P48950	Ø100 x 220mm Pendulum	EACH	£4.95

**Regular Brass Aluminium Patterned, Chinese**

Patterned Pendulums - Brass Aluminium

- Patterned bob
- For quartz clock movements
- Brass colour
- Made from aluminium
- Made in China

Dimensions: Bob Diameter x Overall Length

See website additional images for pattern close up

Code	Description	UOM	Price
P46019	Ø70 x 170mm Patterned Brass Pendulum	EACH	£4.95



**Regular Brass Aluminium Patterned, Chinese**



Patterned Pendulums - Brass Aluminium

- Patterned bob
- For quartz clock movements
- Brass colour
- Made from aluminium
- Made in China

Dimensions: Bob Diameter x Overall Length

See website additional images for pattern close up

Code	Description	UOM	Price
P48947	Ø75mm x 180mm Pendulum	EACH	£4.95
P48948	Ø100mm x 220mm Pendulum	EACH	£4.95

**Regular Brass, Hermle**

Wall Clock Pendulum - Rods - Bobs

- Choose rod & bob combination that will fit
- Rods can be shortened to requirement
- Polished brass unless otherwise stated
- For quartz clock movements
- Made in Germany

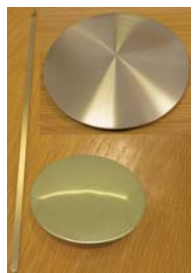

Online Discounts

ORDER tracking

Weight Hooks & Rings

See Page 1372



Pendulums manufactured by Hermle Germany. Will fit any quartz clock movement (may need adapting to fit)

Code	Description	UOM	Price
P42177	Bob Ø55mm	EACH	£7.95
P42178	Bob Ø70mm	EACH	£6.50
P42179	Bob Ø80mm	EACH	£6.50
P42180	Rod 350mm	EACH	£3.95
P42180A	Rod 400mm	EACH	£4.25
P42181	Rod 500mm	EACH	£4.50
P42181A	Rod 600mm	EACH	£5.25
P42182	Rod 760mm	EACH	£5.95

### Regular Brass, UTS

Quartz Movement Pendulum & Bob

- Bob Ø70mm
- Spun brass finish
- Rod Length 600mm (Reduce to Suit)
- UTS
- Made in Germany



For all quartz pendulum movements (may need adapting to suit)

Code	Description	UOM	Price
J3129	Pendulum & Bob	EACH	£4.95
Price breaks available, see website			

### Regular Bronze Aluminium, Chinese

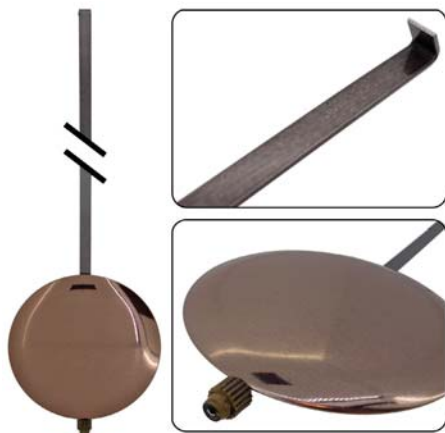

Bronze Pendulums

- Rod & bob
- Rods can be shortened to requirement
- Bronze, antique colour
- Made from aluminium
- For quartz clock movements
- Made in China

Dimensions

- Bob diameter Ø x overall length

Code	Description	UOM	Price
P48063	Ø80 x 245mm Bronze Pendulum	EACH	£2.95

### Regular Bronze Aluminium Patterned, Chinese



Bronze Pendulums

- Rod & bob
- Rods can be shortened to requirement
- Bronze, antique colour
- Made from aluminium
- For quartz clock movements
- Made in China

Dimensions

- Bob diameter Ø x overall length

See website additional images for pattern close up

Code	Description	UOM	Price
P48946	Ø60mm x 220mm Bronze Pendulum	EACH	£4.95

### Regular Steel Aluminium, Chinese



Steel Pendulums

- Rod & bob
- Rods can be shortened to requirement
- Polished steel colour
- Made from aluminium
- For quartz clock movements
- Made in China

Dimensions

- Bob diameter Ø x overall length

Code	Description	UOM	Price
P48055	Ø60 x 220mm SS Pendulum	EACH	£2.95
P48056	Ø70 x 240mm SS Pendulum	EACH	£2.95
P48057	Ø80 x 280mm SS Pendulum	EACH	£3.25
P48058	Ø88 x 280mm SS Pendulum	EACH	£3.50

### Regular Steel, Hermle

Wall Clock Pendulum - Rods - Bobs

- Choose rod & bob combination that will fit
- Rods can be shortened to requirement
- Plain Style
- Polished steel bob
- For quartz clock movements
- Made in Germany



Pendulums manufactured by Hermle Germany. Will fit any quartz clock movement (may need adapting to fit)

Code	Description	UOM	Price
P42166	Bob Ø55mm	EACH	£8.95
P42167	Bob Ø70mm	EACH	£6.95
P42168	Bob Ø80mm	EACH	£6.95
P42169	Rod 350mm	EACH	£3.95
P42170	Rod 500mm	EACH	£4.50
P42171	Rod 700mm	EACH	£4.95

## PINS TAPERED

## BRASS CLOCK PINS - BY SIZE

### Brass Clock Pins, by Size



Clock Pins - Brass - Tapered - by Size

Cousins clock pins are accurately tapered and cut without difficulty. Individually Graded Packets of approx 100 pieces per size.

- Made in Germany
- Tapered Brass
- 12 Individual Sizes
- 100 Pieces per Pack per Size

Dimensions: Smallest Ø x Largest Ø x Length

Code	Description	UOM	Price
P1189	No.1 (Ø0.30mm x 0.60mm) 11mm	PACK*100	£2.70
P1190	No.2 (Ø0.50mm x 0.80mm) 11mm	PACK*100	£2.70
P1191	No.3 (Ø0.60mm x 1.00mm) 11mm	PACK*100	£2.70
P1192	No.4 (Ø0.65mm x 1.10mm) 14mm	PACK*100	£2.70
P1193	No.5 (Ø0.75mm x 1.15mm) 14mm	PACK*100	£2.70
P15247	No.5 (Ø0.75mm x 1.15mm) 14mm, Bulk	PK*5000	£125.00
P1194	No.6 (Ø0.80mm x 1.20mm) 14mm	PACK*100	£2.70
P15248	No.6 (Ø0.80mm x 1.20mm) 14mm, Bulk	PK*25000	£595.00
P1195	No.7 (Ø1.10mm x 1.30mm) 15mm	PACK*100	£2.70
P1196	No.8 (Ø1.10mm x 1.40mm) 15mm	PACK*100	£2.70
P15249	No.8 (Ø1.10mm x 1.40mm) 15mm, Bulk	PK*25000	£595.00

www. Online Discounts

OVER 130,000 DIFFERENT ITEMS

PRICE PROMISE GUARANTEE

<b>P1197</b>	No.9 (Ø1.15mm x 1.50mm) 15mm	PACK*100	<b>£2.70</b>
<b>P15250</b>	No.9 (Ø1.15mm x 1.50mm) 15mm, Bulk	PK*25000	<b>£595.00</b>
<b>P1198</b>	No.10 (Ø1.20mm x 1.60mm) 16mm	PACK*100	<b>£2.95</b>
<b>P1199</b>	No.11 (Ø1.30mm x 1.70mm) 16mm	PACK*100	<b>£2.95</b>
<b>P1200</b>	No.12 (Ø1.40mm x 1.75mm) 16mm	PACK*100	<b>£2.95</b>
<b>P15251</b>	No.12 (Ø1.40mm x 1.75mm) 16mm, Bulk	PK*5000	<b>£125.00</b>
<b>P15252</b>	No.12 (Ø1.40mm x 1.75mm) 16mm, Bulk	PK*25000	<b>£595.00</b>

**Steel Clock Pins, Universal**



Clock Pins - Steel - Tapered - Universal

Cousins "Universal" clock pins are a 25.4mm long pin that covers most sizes. Packets of approx 100 pieces.

- Made in Germany
- Accurately Tapered Steel
- Cut Without Difficulty
- 100 Pieces per Pack

Code	Description	UOM	Price
<b>P4923</b>	Universal (Ø0.70mm x Ø1.80mm) 25.4mm Clock Pins	PACK*100	<b>£4.45</b>
<b>P38489</b>	Universal (Ø1.50mm x Ø2.40mm) 25.4mm Clock Pins	PACK*100	<b>£4.25</b>
Price breaks available, see website			

**Steel Clock Pins, XL (One Size)**



Clock Pins - Steel - Tapered - XL

Cousins "Extra Large" clock pins are a 32mm long pin that covers the the pin requirements that are larger than our individually sized & universal gauged pins. Packets of approx 100 pieces.

- Made in Germany
- Accurately Tapered Steel
- Ideal for False Plates & Worn Holes
- One "XL" Size
- 100 Pieces per Pack

Dimensions:  
 • Smallest Ø1.80mm  
 • Largest Ø2.60mm  
 • Length 32mm

Code	Description	UOM	Price
<b>P4922</b>	Steel Extra Large Clock Pins	PACK*100	<b>£4.95</b>

**GAUGED SETS OF CLOCK PINS**

**Brass Clock Pins**

Clock Pins - Brass - Tapered - Box Sets & Assortments

Swiss Made clock pins are accurately tapered and cut without difficulty. Individually Graded box sets or assorted, available in different quantities to suit your volume use.

- Swiss Made
- Tapered Brass
- Graded or Assorted
- Various Quantities Available

**Clock Pins, Brass**



- 500 Pieces
- Swiss Made
- Tapered
- Brass

Code	Description	UOM	Price
<b>P37419</b>	Clock Pins, Brass	PACK*500	<b>£29.95</b>

**Clock Pins, Graded**



- 240 Pieces
- Swiss Made
- Tapered
- Brass
- 10 Different sizes

Code	Description	UOM	Price
<b>P1201</b>	Clock Pins, Graded	PACK*240	<b>£19.95</b>

**Brads Small (Pins) Assorted**

See Page 1248



**Steel Clock Pins, by Size**



Clock Pins - Steel - Tapered - by Size

Cousins clock pins are accurately tapered and cut without difficulty. Individually Graded Packets of approx 100 pieces per size.

- Made in Germany
- Tapered Steel
- 12 Individual Sizes
- 100 Pieces per Pack per Size

Dimensions: Smallest Ø x Largest Ø x Length

N.B. There are two No.7 one is slightly larger

Code	Description	UOM	Price
<b>P1177</b>	No.1 (Ø0.30mm x 0.60mm) 11mm	PACK*100	<b>£2.70</b>
<b>P1178</b>	No.2 (Ø0.50mm x 0.80mm) 11mm	PACK*100	<b>£2.70</b>
<b>P1179</b>	No.3 (Ø0.60mm x 1.00mm) 11mm	PACK*100	<b>£2.70</b>
<b>P1180</b>	No.4 (Ø0.65mm x 1.10mm) 14mm	PACK*100	<b>£2.70</b>
<b>P1181</b>	No.5 (Ø0.75mm x 1.15mm) 14mm	PACK*100	<b>£2.70</b>
<b>P1182</b>	No.6 (Ø0.80mm x 1.20mm) 14mm	PACK*100	<b>£2.70</b>
<b>P22161</b>	No.7 (Ø1.00mm x 1.30mm) 14mm	PACK*100	<b>£2.70</b>
<b>P1183</b>	No.7 (Ø1.10mm x 1.30mm) 15mm	PACK*100	<b>£2.70</b>
<b>P1184</b>	No.8 (Ø1.10mm x 1.40mm) 15mm	PACK*100	<b>£2.70</b>
<b>P1185</b>	No.9 (Ø1.15mm x 1.50mm) 15mm	PACK*100	<b>£2.70</b>
<b>P1186</b>	No.10 (Ø1.20mm x 1.60mm) 16mm	PACK*100	<b>£2.85</b>
<b>P1187</b>	No.11 (Ø1.30mm x 1.70mm) 16mm	PACK*100	<b>£2.85</b>
<b>P1188</b>	No.12 (Ø1.40mm x 1.75mm) 16mm	PACK*100	<b>£2.85</b>

**Contact & Services**

**Your direct line to our Management Team**

*All correspondence is time stamped and answered within 1 hour of receipt*  
**Instant Message Service**



**Clock Pins, Graded**



- 100 Pieces
- Swiss Made
- Tapered
- Brass
- 10 Different sizes

Code	Description	UOM	Price
P37417	Clock Pins, Graded	PACK*100	£8.95

**Brass Clock Pins, XL**



Clock Pins - Brass - Tapered - "Extra Large"  
 Swiss Made "Extra Large" clock pins are a long pin that covers the the pin requirements that are larger than our individually sized & universal gauged pins. Packets of approx 100 pieces.

- Swiss Made
- Tapered Brass
- Assorted

Code	Description	UOM	Price
P1204	Brass Extra Large Clock Pins	PACK*100	£9.95

**Steel Clock Pins**

Clock Pins - Steel - Tapered - Box Sets & Assortments

Swiss Made clock pins are accurately tapered and cut without difficulty. Individually Graded box sets or assorted, available in different quantities to suit your volume use.

- Swiss Made
- Tapered Steel
- Graded or Assorted
- Various Quantities Available

**Clock Pins, Assorted**



- 500 Pieces
- Swiss Made
- Tapered
- Steel

Code	Description	UOM	Price
P37418	Clock Pins, Assorted	PACK*500	£35.95

**Clock Pins, Graded**



- 240 Pieces
- Swiss Made
- Tapered
- Steel
- 10 Different sizes

Code	Description	UOM	Price
P1202	Clock Pins, Graded	PACK*240	£17.75

**Clock Pins, Graded**



- 100 Pieces
- Swiss Made
- Tapered
- Steel
- 10 Different sizes

Code	Description	UOM	Price
P37416	Clock Pins, Graded	PACK*100	£14.75

**Steel Clock Pins, XL**



Clock Pins - Steel - Tapered - "Extra Large"  
 Swiss Made "Extra Large" clock pins are a long pin that covers the the pin requirements that are larger than our individually sized & universal gauged pins. Packets of approx 100 pieces.

- Swiss Made
- Tapered Steel
- Assorted

Code	Description	UOM	Price
P1205	Steel Extra Large Clock Pins	PACK*100	£9.95

**Steel & Brass, Assorted**

**Brass & Steel Clock Pins**



Clock Pins - Steel & Brass - Tapered - Assorted  
 Clock pins are tapered and cut without difficulty

- Tapered Brass & Steel
- Assorted
- Various different diameters
- All 25mm long

Code	Description	UOM	Price
P47506	Brass & Steel Clock Pins	PACK*100	£4.95

**Steel & Brass, Graded Box**

**Standard Steel and Brass Clock Pins, Graded Box**



Clock Pins - Steel & Brass - Tapered - Box Set  
 Swiss Made clock pins are accurately tapered and cut without difficulty. Individually Graded box set.

- Swiss Made
- Tapered Brass & Steel
- Graded Box
- 10 Different Sizes

Code	Description	UOM	Price
P1203	Standard Steel and Brass Clock Pins, Graded Box	PACK*240	£22.95

**TODAY SAME DAY DISPATCH**

**Clock Restoration (Case, Dial etc)**

**See Page 1169**



**Steel & Brass, Graded Box, XL**

**Extra Large Clock Pins**



Clock Pins - Steel & Brass - Tapered - "Extra Large"  
Swiss Made "Extra Large" clock pins are a long pin that covers the pin requirements that are larger than our individually sized & universal gauged pins. Packets of approx 100 pieces.

- Swiss Made
- Tapered Steel
- Assorted

Code	Description	UOM	Price
<b>P1206</b>	Extra Large Clock Pins	PACK*120	<b>£18.95</b>

**PLATFORMS**



SwissMade - Gorge - Platform Escapements  
Plate Dimensions: Width x Length

- 18 x 28mm (No.11)
- 22.5 x 35.6mm (No.2)
- 24 x 44mm (No.3)
- 25 x 35.8mm (No.2C)
- 25.1 x 37.7mm (No.2A)
- 29.5 x 41.5mm (No.4)

Platform parts are not interchangeable with "very old" Gorge platforms or "non" Gorge platforms.

**18 x 28mm (Gorge No.11)**



Gorge Swiss Made Platform Escapement

Plate Size: 18mm x 28mm

Dimensions:

- Width 18mm
- Length 28mm
- Alt. Frequency 18000 Alt/h
- Pallet wheel rotation: Right
- Finely tumbled surface
- Position of pinion: 9mm from 3 sides of the base plate
- Depth of pinion: 4.6mm max below the base plate

Code	Description	UOM	Price
<b>P39203</b>	No.11 Gorge Platform	EACH	<b>£139.95</b>

**22.5 x 35.6mm (Gorge No.2)**



Gorge Swiss Made Platform Escapement

Plate Size: 22.5mm x 35.6mm

Dimensions:

- Width 22.5mm
- Length 35.6mm
- 8 Leaf Escape Wheel
- Escape Wheel Drop 9.5mm (distance from the plate to the end of the bracket holding the pinion)
- Escape Wheel Pivot to Plate Tip 9mm

Code	Description	UOM	Price
<b>VT5240</b>	No.2 Gorge Platform	EACH	<b>£93.95</b>

**24 x 44mm (Gorge No.3)**



Gorge Swiss Made Platform Escapement

Plate Size: 24mm x 44mm

Dimensions:

- Width 24mm
- Length 44mm
- 8 Leaf Escape Wheel
- Escape Wheel Drop 9.5mm (distance from the plate to the end of the bracket holding the pinion)
- Escape Wheel Pivot to Plate Tip 17mm

Code	Description	UOM	Price
<b>AU6792</b>	No.3 Gorge Platform	EACH	<b>£93.95</b>

**25 x 35.8mm (Gorge No.2C)**

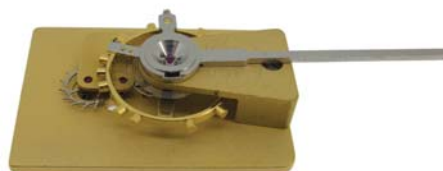

Gorge Swiss Made Platform Escapement

Plate Size: 25mm x 35.8mm

Dimensions:

- Width 25mm
- Length 35.8mm
- 8 Leaf Escape Wheel
- Escape Wheel Drop 9.5mm (distance from the plate to the end of the bracket holding the pinion)
- Escape Wheel Pivot to Plate Tip 9mm

Code	Description	UOM	Price
<b>WM3489</b>	No.2C Gorge Platform	EACH	<b>£93.95</b>

**25.1 x 37.7mm (Gorge No.2A)**



Gorge Swiss Made Platform Escapement

Plate Size: 25.1mm x 37.7mm

Dimensions:

- Width 25.1mm
- Length 37.7mm
- 8 Leaf Escape Wheel
- Escape Wheel Drop 9.5mm (distance from the plate to the end of the bracket holding the pinion)
- Escape Wheel Pivot to Plate Tip 10mm

Code	Description	UOM	Price
<b>QS7321</b>	No.2A Gorge Platform	EACH	<b>£93.95</b>

**29.5 x 41.5mm (Gorge No.4)**

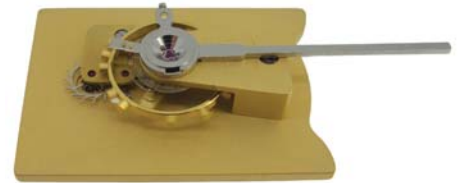

Gorge Swiss Made Platform Escapement

Plate Size: 29.5mm x 41.5mm

Dimensions:

- Width 29.5mm
- Length 41.5mm
- 8 Leaf Escape Wheel
- Escape Wheel Drop 9.5mm (distance from the plate to the end of the bracket holding the pinion)
- Escape Wheel Pivot to Plate Tip 10mm

Code	Description	UOM	Price
<b>BN9813</b>	No.4 Gorge Platform	EACH	<b>£93.95</b>

**Balance Complete (Gorge Escapement)**



Gorge Clock Escapement - Balance Complete

These balance completes are specific to the Gorge platforms we sell and are sold by the Gorge platform number. They are not interchangeable with "very old" Gorge platforms or "non" Gorge platforms.

- Gorge
- Swiss Made
- Highest Quality

P7625 for:

- No.2 (VT5240)
- No.2A (QS7321)
- No.2C (WM3489)
- No.3 (AU6792)
- No.4 (BN9813)

P40659 for:

- No.11 (P39203)

Code	Description	UOM	Price
<b>P7625</b>	Balance Complete (No.2, 2A, 2C, 3 & 4)	EACH	<b>£31.75</b>
<b>P40659</b>	Balance Complete (No.11)	EACH	<b>£49.95</b>

**Balance Staff (Gorge Escapement)**

Gorge Clock Escapement - Balance Staff

These balance staffs are specific to the Gorge platforms we sell and are sold by the Gorge platform number. They are not interchangeable with "very old" Gorge platforms or "non" Gorge platforms therefore the sizes are not given.



- Gorge
- Swiss Made
- Highest Quality

Platform P7626A (Only) for:  
• No.1 (CX1001)

Platform P7626 (Only) for:  
• No.2 (VT5240)  
• No.2A (QS7321)  
• No.2C (WM3489)  
• No.3 (AU6792)  
• No.4 (BN9813)

Platform P40660 (Only) for:  
• No.11 (P39203)

Not interchangeable with another platforms

Code	Description	UOM	Price
<b>P7626A</b>	Balance Staff (No.1)	EACH	<b>£7.25</b>
<b>P7626</b>	Platform 2, 2A, 2C, 3, 4 Staffs	EACH	<b>£6.25</b>
<b>P40660</b>	Balance Staff (No.11)	EACH	<b>£8.95</b>

### Escape Wheel (Gorge Escapement)



Gorge Clock Escapement - Escape Wheels

These escape wheels are specific to the Gorge platforms we sell and are sold by the Gorge platform number. They are not interchangeable with "very old" Gorge platforms or "non" Gorge platforms therefore the sizes are not given.

- Gorge
- Swiss Made
- Highest Quality
- Various Leaf Count (Pinion Teeth)
- New platforms are supplied with an 8 leaf pinion escape wheel

Escape Wheels:

- No.2 = For platforms numbers 2A, 2C, 3 & 4

Code	Description	UOM	Price
<b>P9314A</b>	No.1 (6 Leaf) Escape Wheel	EACH	<b>£33.95</b>
<b>P9314B</b>	No.1 (7 Leaf) Escape Wheel	EACH	<b>£33.95</b>
<b>P9314C</b>	No.1 (8 Leaf) Escape Wheel	EACH	<b>£33.95</b>
<b>P7627C</b>	No.2 (6 Leaf) Escape Wheel	EACH	<b>£33.95</b>
<b>P7627B</b>	No.2 (7 Leaf) Escape Wheel	EACH	<b>£24.95</b>
<b>P7627</b>	No.2 (8 Leaf) Escape Wheel	EACH	<b>£24.95</b>
<b>P7627A</b>	No.2 (9 Leaf) Escape Wheel	EACH	<b>£24.95</b>
<b>P40658</b>	No.11 (6 Leaf) Escape Wheel	EACH	<b>£37.50</b>
<b>P40657</b>	No.11 (8 Leaf) Escape Wheel	EACH	<b>£37.50</b>

### Pallets (Gorge Escapement)

Gorge Clock Escapement - Pallet

These pallets are specific to the Gorge platforms we sell and are sold by the Gorge platform number. They are not interchangeable with "very old" Gorge platforms or "non" Gorge platforms therefore the sizes are not given.



- Gorge

- Swiss Made
- Highest Quality

P7628A for:  
• No.1 (CX1001)

P7628 for:  
• No.2 (VT5240)  
• No.2A (QS7321)  
• No.2C (WM3489)  
• No.3 (AU6792)  
• No.4 (BN9813)

P40661 for:  
• No.11 (P39203)

Code	Description	UOM	Price
<b>P7628A</b>	Pallet (No.1)	EACH	<b>£28.85</b>
<b>P7628</b>	Pallet (No.2, 2A, 2C, 3 & 4)	EACH	<b>£28.85</b>
<b>P40661</b>	Pallet (No.11)	EACH	<b>£36.50</b>

### Regulator Arm (Gorge Escapement)

Gorge Clock Escapement - Regulator Arm

These regulator arms are specific to the Gorge platforms we sell and are sold by the Gorge platform number. They are not interchangeable with "very old" Gorge platforms or "non" Gorge platforms.



- Gorge
- Swiss Made
- Highest Quality

P7799A for:  
• No.1 (CX1001)

P7799 for:  
• No.2 (VT5240)  
• No.2A (QS7321)  
• No.2C (WM3489)  
• No.3 (AU6792)  
• No.4 (BN9813)

P40665:  
• No.11 (P39203)

Code	Description	UOM	Price
<b>P7799A</b>	Regulator Arm (No.1)	EACH	<b>£9.25</b>
<b>P7799</b>	Regulator Arm (No.2, 2A, 2C, 3 & 4)	EACH	<b>£6.95</b>
<b>P40665</b>	Regulator Arm (No.11)	EACH	<b>£8.95</b>

### Regulator Index (Gorge Escapement)

Gorge Clock Escapement - Regulator Index

These regulator indexes are specific to the Gorge platforms we sell and are sold by the Gorge platform number. They are not interchangeable with "very old" Gorge platforms or "non" Gorge platforms.



- Gorge
- Swiss Made
- Highest Quality

P7798A for:  
• No.1 (CX1001)

P7798 for:  
• No.2 (VT5240)  
• No.2A (QS7321)  
• No.2C (WM3489)  
• No.3 (AU6792)  
• No.4 (BN9813)

P40664 for:  
• No.11 (P39203)

Code	Description	UOM	Price
<b>P7798A</b>	Regulator/Index (No.1)	EACH	<b>£15.15</b>
<b>P7798</b>	Regulator/Index (No.2, 2A, 2C, 3 & 4)	EACH	<b>£9.95</b>
<b>P40664</b>	Regulator Index (No.11)	EACH	<b>£22.75</b>

### Upper Shock Setting (Gorge Escapement)

Gorge Clock Escapement - Upper Shock Setting

These upper shock settings are specific to the Gorge platforms we sell and are sold by the Gorge platform number. They are not interchangeable with "very old" Gorge platforms or "non" Gorge platforms.



- Gorge
- Swiss Made
- Highest Quality

P9316 for:  
• No.1 (CX1001)

P7800A for:  
• No.2 (VT5240)  
• No.2A (QS7321)  
• No.2C (WM3489)  
• No.3 (AU6792)  
• No.4 (BN9813)

P40662 for:  
• No.11 (P39203)

Code	Description	UOM	Price
<b>P9316</b>	Upper Setting (No.1)	EACH	<b>£33.50</b>
<b>P7800A</b>	Upper Setting (No.2, 2A, 2C, 3 & 4)	EACH	<b>£9.95</b>
<b>P40662</b>	Upper Setting (No.11)	EACH	<b>£34.95</b>

### Lower Shock Setting (Gorge Escapement)

Gorge Clock Escapement - Lower Shock Setting

These lower shock settings are specific to the Gorge platforms we sell and are sold by the Gorge platform number. They are not interchangeable with "very old" Gorge platforms or "non" Gorge platforms.



- Gorge
- Swiss Made
- Highest Quality

P9315 for:  
• No.1 (CX1001)

P7800 for:  
• No.2 (VT5240)  
• No.2A (QS7321)  
• No.2C (WM3489)  
• No.3 (AU6792)  
• No.4 (BN9813)

P40663 for:  
• No.11 (P39203)

Code	Description	UOM	Price
<b>P9315</b>	Lower Setting (No.1)	EACH	<b>£33.50</b>
<b>P7800</b>	Lower Setting (No.2, 2A, 2C, 3, 4)	EACH	<b>£9.95</b>
<b>P40663</b>	Lower Setting (No.11)	EACH	<b>£34.95</b>

# FLUID OFFER

February & August Only



Description:	Ref:	Price:
L&R 111 Watch Cleaning Fluid	3.8 litres F2805	£34.75
L&R 566 Watch Cleaning Fluid	3.8 litres F2806	£35.75
L&R No3 Watch Cleaning Fluid	3.8 litres F2804	£34.75
L&R Ultrasonic Watch Rinsing Fluid	3.8 litres F2802	£32.95
L&R 677 Clock Cleaning Fluid.....	3.8 litres F2792	£35.75
L&R Clock Cleaner Concentrate Fluid.....	3.8 litres F2794	£39.75
L&R Clock Lube.....	3.8 litres F47529	£34.95
L&R Jewellery Cleaner, Ammoniated.....	3.8 litres F2799	£28.75
L&R Jewellery Cleaner, Non Ammoniated..	3.8 litres F31029	£30.95
L&R Extra Fine Watch Cleaning Fluid	3.8 litres F19542	£35.95



Description:	Ref:	Price:
Greiner Watch Cleaning Concentrate .....	50 ml F7330	£7.50



New Formula

Description:	Ref:	Price:
Elma WF Pro Cleaner - (New Formula)	2.5 litres R37683	£23.95
	10 litres R37684	£78.95
	25 litres R37685	£175.00
Elma Surprol Pro Rinse - (New Formula)	2.5 litres R37686	£23.95
	10 litres R37687	£89.95
	25 litres R37688	£189.95



Description:	Ref:	Price:
Horolene Clock Concentrate	250 ml F6472	£9.45
	500 ml F6473	£13.75
	1 litre F6474	£21.95
	2.5 litres F6475	£38.95
	5 litres F2808	£68.75



Description:	Ref:	Price:
Silver Dip.....	2 litres P8659	£10.95
Silver Polish .....	2 litres P32662	£13.00
Ultrasonic Jewel Clean.....	2 litres P8658	£13.75



An improved extra strong cleaner for the escapement inclusive of hairspring.



Description:	Ref:	Price:
Bergeon F45 Solution	1 litre F2813	£39.95
	5 litres F2814	£145.00
Bergeon Rubisol Cleaning Fluid	5 litres F2815	£125.00



Best seller for over a decade

Description:	Ref:	Price:
Cousins Jewellery Cleaner.....	1 litre C4362	£7.95
	5 litres C4363	£34.95

**YOUR ORDER DELIVERED FREE\***  
WHEN YOU INCLUDE 4 OR MORE GALLONS



In the months of February & August only Include 4 or more gallons with your order and get the whole delivery free carriage

\*OFFER AVAILABLE TO UK MAINLAND EXCLUDING NORTH OF EDINBURGH & GLASGOW, ABOVE EDINBURGH & GLASGOW DELIVERY HALF PRICE. OFFSHORE ISLANDS PLEASE ASK FOR COMPETITIVE DELIVERY QUOTE.

### Escapement Securing Screws (Clock)

Clock Platform Escapement Securing Screw

For securing clock platforms in position.

- Traditional Style
- Steel
- Cylindrical Headed
- Suitable for Gorge Platforms
- High Quality
- Packs of 10 per size
- Made in UK



Thread diameters:

- 1.0mm
- 1.2mm
- 1.4mm
- 1.6mm
- 1.8mm

Code	Description	UOM	Price
S6494	Ø1.0mm Securing Screws	PACK*10	£4.85
S6495	Ø1.2mm Securing Screws	PACK*10	£4.85
S6496	Ø1.4mm Securing Screws	PACK*10	£4.85
S6497	Ø1.6mm Securing Screws	PACK*10	£4.85
S6498	Ø1.8mm Securing Screws	PACK*10	£4.85

## PULLEYS

### Longcase, Chain

Longcase Clock - Chain Pulley

Very high quality chain pulley with ornate profile & one piece forged stirrup.

- Ø1½ inch (38mm)
- Machined from solid brass
- Complete with one piece forged steel stirrup
- Made in UK



Code	Description	UOM	Price
P1420	Long Case Chain Pulley	EACH	£10.25

### Longcase, Gut



Longcase Clock - Gut Pulley

- Ø1½ inch (38mm) or Ø1¾" (44mm)
- Machined from solid brass
- Complete with one piece forged steel stirrup
- Made in UK

Code	Description	UOM	Price
P1421	Ø1½" (38mm) Pulley	EACH	£8.95
P32019	Ø1½" (38mm) Pulley, Indian	EACH	£5.75
P1422	Ø1¾" (44mm) Pulley	EACH	£12.25

### Longcase, Rope

Longcase Clock - Chain Pulley

Very high quality rope pulley with ornate profile & one piece forged stirrup.

- Ø1½ inch (38mm)
- Machined from solid brass
- Complete with one piece forged steel stirrup
- Made in UK



Code	Description	UOM	Price
P1423	Ø1½" (38mm) Pulley	EACH	£8.95

### Universal Pulley

Clock Pulley

- Universal clock pulley
- Ø1¾" (44mm) overall diameter
- Brass finish aluminium alloy
- Can hold chain, gut or rope up to Ø1.90mm



Code	Description	UOM	Price
P46070	Ø1¾" (44mm) Pulley	EACH	£11.95

### Vienna Regulator (ØTBA)

Vienna Regulator (VR) Clock Pulley

- Hermle Pulley
- For all Hermle cable driven movements
- Manufactured by Hermle
- Made in Germany



Code	Description	UOM	Price
P45720	Pulley, Hermle B026.01670	EACH	£11.95

### Vienna Regulator (ØTBA)

Vienna Regulator (VR) Clock Pulley

- Urgos Pulley
- For all Urgos cable driven movements
- Manufactured by Hermle
- Made in Germany



Code	Description	UOM	Price
P45721	Pulley, Hermle B026.06670	EACH	£12.95

#### Long Case Clock Brass Weights (& Shells)

See Page 1367

### Vienna Regulator (Ø25mm), Gut

Vienna Regulator (VR) Clock Pulley - Ornate - Ø25mm

- Ø25mm
- With Ornate full stirrup brace
- Solid brass
- Width of groove: 1mm
- Made in Germany



Code	Description	UOM	Price
P8947	Ø25mm (VR) Gut	EACH	£19.85

### Vienna Regulator (Ø30mm), Gut

Vienna Regulator (VR) Clock Pulley - Ø30mm

- Ø30mm
- Brass Stirrup
- Polished brass
- Well defined finish
- Width of groove: 1mm Max
- Made in UK



Code	Description	UOM	Price
P1424	Ø30mm (VR) Gut	EACH	£12.50

### Vienna Regulator (Ø45mm), Gut

Vienna Regulator (VR) Clock Pulley - Ø45mm

- Ø45mm
- Brass Stirrup
- In Turned Brass
- Width of groove: 1.75mm Max
- Made in Germany



Code	Description	UOM	Price
P1426	Ø45mm (VR) Gut	EACH	£19.25

## QUICK PIVOTS

### Clock Wheel Quick Pivots



Clock Wheel Quick Pivots

Turned steel pivot ends for projects where professional repivoting is not feasible

- Steel
- Original pinion shaft may need adjustment
- Set, Pack of 12 (2 of each 6 sizes)
- Individually Graded Packs of 2
- Designed to be friction fitted to the pinion
- They can also be held on with a very small amount of super glue

Dimensions:

- Pivot Diameter (C)
- Shaft Fitting Diameter (B)
- Overall Length (L)

Code	Description	UOM	Price
P9633A	Set of Quick Pivots	PACK*12	£10.95

## RATCHET WHEELS

P9634	0.55mm x 0.95mm x 3.80mm Pivots	PACK*2	£1.95
P9635	0.65mm x 1.30mm x 3.50mm Pivots	PACK*2	£1.95
P9636	1.05mm x 1.80mm x 5.00mm Pivots	PACK*2	£1.95
P9637	1.60mm x 1.90mm x 6.50mm Pivots	PACK*2	£1.95
P9638	1.60mm x 3.20mm x 7.00mm Pivots	PACK*2	£1.95
P9639	2.00mm x 4.00mm x 9.00mm Pivots	PACK*2	£1.95

R2545	Ø15mm Brass Ratchet Wheel	EACH	£2.45
R2546	Ø16mm Brass Ratchet Wheel	EACH	£2.45
R2547	Ø17mm Brass Ratchet Wheel	EACH	£2.45
R2548	Ø18mm Brass Ratchet Wheel	EACH	£2.45
R2549	Ø19mm Brass Ratchet Wheel	EACH	£2.45
R2550	Ø20mm Brass Ratchet Wheel	EACH	£2.45

## RIVETS

### Clock Rivet Assortment, Brass

Clock Brass Rivet - Assortment

For securing clicks, click springs and many other aspects of repair work in clock, antique & toy repair.

- Solid Brass
- For All Clocks
- Various sizes
- Pack of 100 pieces

Code	Description	UOM	Price
A4949	Clock Brass Rivet Assortment	PACK*100	£2.95



## RATCHET WHEELS

### Ratchet Wheel (Set Up), English Dial

English Dial, Fusee - Set Up Ratchet Wheel

- Brass
- Ø26mm
- 4mm Square
- Made in Great Britain



Code	Description	UOM	Price
P34570	Fusee Set-Up Ratchet	EACH	£14.95

### Ratchet Wheels



Ratchet Wheels for Clocks - by Size

- French Clock
- 18 or 20 Teeth
- Brass
- File to fit centre square
- Ø15, 16 or 17mm

Dimensions: Outside Diameter

Code	Description	UOM	Price
R39692	Ø15mm, 18 Teeth Ratchet Wheel	EACH	£0.95
R39691	Ø16mm, 18 Teeth Ratchet Wheel	EACH	£0.95
R39690	Ø17mm, 20 Teeth Ratchet Wheel	EACH	£0.95

### Ratchet Wheels, UK Made



Ratchet Wheels for Clocks - by Size

- French Clock
- Thickness 2mm
- 20 Teeth
- Brass
- File to fit centre square
- By Size: Ø10mm to Ø20mm
- Made in UK

Dimensions: Outside Diameter

Code	Description	UOM	Price
R2540	Ø10mm Brass Ratchet Wheel	EACH	£2.45
R2541	Ø11mm Brass Ratchet Wheel	EACH	£2.45
R2542	Ø12mm Brass Ratchet Wheel	EACH	£2.45
R2543	Ø13mm Brass Ratchet Wheel	EACH	£2.45
R2544	Ø14mm Brass Ratchet Wheel	EACH	£2.45

## SCREWS (INC. DIAL SCREWS)

Various Types, shapes & sizes for small travel alarm to large clocks, brass & steel

### BA (Sizes) Assorted

BA Screw Sizes - Assorted

- BA Sizes: 3, 4, 5, 6, 7, 8, 9, 10BA
- Steel
- Cheese Head
- Various Lengths
- 40 Pieces
- UK Made

Code	Description	UOM	Price
L34533	BA (Sizes) Screw Assortment	PACK*40	£10.75



## Donegan Optivisors



See Page: 937

## Case Screws, Clock

### Countersunk Screw Assortment

- Counter Sunk Heads
- Self Tapping
- Brass
- 200 pieces



Code	Description	UOM	Price
S8946	Countersunk Screw Assortment	PACK*200	£19.95

### Domed Screw Assortment

- Domed Heads
- Self Tapping
- Brass
- 200 pieces



Code	Description	UOM	Price
S8945	Domed Screw Assortment	PACK*200	£19.95

### Mixed Screws Assortment

- Counter Sunk Heads
- Domed Heads
- Self Tapping
- Brass & Steel
- 100 Pieces



Code	Description	UOM	Price
A31278	Mixed Screws Assortment	PACK*100	£3.50

## Dial Screws, Clock

Clock Dial Screws

- Brass
- Square Headed (6.5mm)
- Overall Length 11mm
- 2BA or 3BA Thread
- Blank to hole in vice & tap you own thread

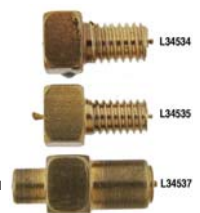

Code	Description	UOM	Price
L34534	2BA Clock Dial Screw	EACH	£1.75
L34535	3BA Clock Dial Screw	EACH	£1.75
L34537	Blank Clock Dial Screw (cut your own thread)	EACH	£2.75

## General Assorted, Clock

### General Clock Assortment, Brass

- Brass
- Long and short threads
- General purpose
- For everyday requirements
- 100 pieces per pack



Code	Description	UOM	Price
A4953A	General Clock Assortment, Brass	PACK*100	£3.50

### General Clock Assortment, Steel

- Brass
- Long and short threads
- General purpose
- For everyday requirements
- 100 pieces per pack



Code	Description	UOM	Price
A4953	General Clock Assortment, Steel	PACK*100	£3.50

### General Assorted, Clock, Swiss

General Clock Assortment - including Larger Screws

High quality general clock screw assortment which includes some larger screws for larger clocks.



- Swiss Made
- High Quality
- Steel & Brass Mixed
- Long and short threads
- Metric threads
- 150 pieces

Code	Description	UOM	Price
A0019	General Clock Assortment, Swiss	PACK*150	£18.95

## SUSPENSIONS

## AMERICAN ANSONIA CLOCK SUSPENSION

### American Ansonia Suspension Springs



Clock Suspension Springs - American Ansonia

- Various Lengths
- American Ansonia
- Single or packs of 10

Overall Lengths:

- 250mm (10") - Indian
- 425mm (17") - Indian
- 500mm (20") - UK Made

Code	Description	UOM	Price
P32025	250mm (10") Suspension	PACK*10	£1.00
P32026	425mm (17") Suspension	PACK*10	£1.50
S1669	500mm (20") Suspension	EACH	£3.65

Price breaks available, see website



## ANNIVERSARY 400 DAY SUSPENSION COMPLETE UNITS



Dimensions:

- 1st Distance between upper and lower fixing (pinning) points
- 2nd Distance between upper fixing (pinning) point and fork / pin line
- Make and model
- Horolovar number in brackets

Due to the age of some clocks and the factories being no longer in existence or the model being discontinued, the fittings, blocks & forks may look a different shape/design to the original parts, there could also be very slight variables in measurements, however any differences are within tolerances and the technical function is the same.

- S. Haller (Siegfried Haller)
- Haller Jauch
- Henn
- Herr
- Hermle
- Kaiser
- Kern
- Koma
- Kundo
- Link
- Neueck (Wilmac)
- Petersen
- Reiner
- Schatz

### S. Haller (Siegfried Haller)

Suspension Unit - S. Haller (Siegfried Haller)

Dimensions:

- 1st = Distance between upper and lower fixing (pinning) points
- 2nd = Distance between upper fixing (pinning) point and fork / pin line

Listed as:

- 1st x 2nd x Model x (Horolovar No. in Brackets)

S. Haller (Siegfried Haller)

Models:

- 68mm x 7mm, Midget 70 (44)
- 86mm x 7mm, Standard 57 (39)
- 86mm x 9mm, Miniature 70 (43)
- 120mm x 9mm, Standard 70 (42)

Click website "More Information" for additional specification

Code	Description	UOM	Price
S1668	68mm x 7mm Midget 70 (44)	EACH	£13.45
S33365	86mm x 7mm Standard 57 (39)	EACH	£14.95
S1667	86mm x 9mm Miniature 70 (43)	EACH	£13.45

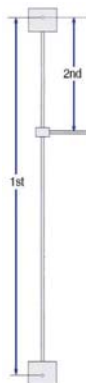

S1666	120mm x 9mm Standard 70 (42)	EACH	£13.45
-------	------------------------------	------	--------

### Haller Jauch

Suspension Unit - Haller Jauch

Dimensions:

- 1st = Distance between upper and lower fixing (pinning) points
- 2nd = Distance between upper fixing (pinning) point and fork / pin line

Listed as:

- 1st x 2nd x Model x (Horolovar No. in Brackets)

Mechanical Models:

- 131mm x 11.5mm, Standard 54 (33)

Click website "More Information" for additional specification

Code	Description	UOM	Price
S33378	131mm x 11.5mm, Standard 54 (33)	EACH	£15.95

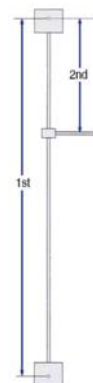

### Henn

Suspension Unit - Henn

Dimensions:

- 1st = Distance between upper and lower fixing (pinning) points
- 2nd = Distance between upper fixing (pinning) point and fork / pin line

Listed as:

- 1st x 2nd x Model x (Horolovar No. in Brackets)

Henn Mechanical Models:

- 106mm x 10mm, Miniature 52 (29A)
- 106mm x 10mm, Miniature 53 (29B)
- 106mm x 10mm, Miniature 52-53 (29C)
- 127mm x 11mm, Standard 54 (32)
- 127mm x 12mm, Standard 52 (31)

Click website "More Information" for additional specification

Code	Description	UOM	Price
S33366	106mm x 10mm Miniature 52 (29A)	EACH	£15.95
S33367	106mm x 10mm Miniature 53 (29B)	EACH	£15.95
S33368	106mm x 10mm Miniature 52-53 (29C)	EACH	£15.95
S33370	127mm x 11mm Standard 54 (32)	EACH	£15.95
S33369	127mm x 12mm Standard 52 (31)	EACH	£15.95

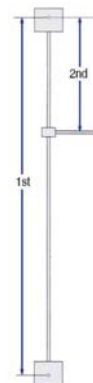

### 400 Day Clock Beat Setting Tool

See Page 776



**Herr**

Suspension Unit - Herr

Dimensions:

- 1st = Distance between upper and lower fixing (pinning) points
- 2nd = Distance between upper fixing (pinning) point and fork / pin line

Listed as:

- 1st x 2nd x Model x (Horolovar No. in Brackets)

Herr Models:

- 98mm x 9mm, Miniature 53 (28A)
- 98mm x 10mm, Miniature 56 (28C)
- 98mm x 12mm, Miniature 54 (28B)
- 118mm x 13mm, Standard 54 (20B)
- 120mm x 12mm, Standard 53 (27A)
- 120mm x 12mm, Standard 54 (20A)
- 120.5mm x 12mm, Standard 55 (27B)

Click website "More Information" for additional specification

Code	Description	UOM	Price
<b>S33375</b>	98mm x 9mm Miniature 53 (28A)	EACH	<b>£15.95</b>
<b>S33377</b>	98mm x 10mm Miniature 56 (28C)	EACH	<b>£15.95</b>
<b>S33376</b>	98mm x 12mm Miniature 54 (28B)	EACH	<b>£15.95</b>
<b>S33374</b>	118mm x 13mm Standard 54 (20B)	EACH	<b>£15.95</b>
<b>S33398</b>	120mm x 12mm Standard 53 (27A)	EACH	<b>£16.95</b>
<b>S33373</b>	120mm x 12mm Standard 54 (20A)	EACH	<b>£15.95</b>
<b>S33399</b>	120.5mm x 12mm Standard 55 (27B)	EACH	<b>£15.95</b>

**Hermle**

Suspension Unit - Hermle

Dimensions:

- 1st = Distance between upper and lower fixing (pinning) points
- 2nd = Distance between upper fixing (pinning) point and fork / pin line

Listed as:

- 1st x 2nd x Model x (Horolovar No. in Brackets)

Hermle Models:

- Mechanical
- Quartz
- Electronic

Click website "More Information" for additional specification

Code	Description	UOM	Price
<b>S1657</b>	65mm x 18mm Quartz 977.2B	EACH	<b>£5.75</b>
<b>S1660</b>	65mm x 20mm Quartz 2300.005/6	EACH	<b>£5.75</b>
<b>S1659</b>	66mm x 22mm Quartz 2300.007	EACH	<b>£5.75</b>
<b>S1661</b>	81mm x 26mm Quartz 2300.003	EACH	<b>£5.75</b>
<b>S1658</b>	82mm x 21mm Quartz 987	EACH	<b>£5.75</b>
<b>S1662</b>	82mm x 26mm Quartz 2300.008	EACH	<b>£5.75</b>
<b>S1653</b>	85mm x 7mm Quartz 967	EACH	<b>£5.75</b>
<b>S1654</b>	85mm x 7mm Quartz 977	EACH	<b>£5.75</b>
<b>S33411</b>	85.5mm x 7.5mm Electronic 75 (53B)	EACH	<b>£15.95</b>
<b>S33412</b>	85.5mm x 7.5mm Quartz 77 (54A)	EACH	<b>£15.95</b>
<b>S33413</b>	85.5mm x 7.5mm Quartz 77 (54B)	EACH	<b>£15.95</b>
<b>S33416</b>	85.6mm x 7.5mm Standard 80 (67B)	EACH	<b>£15.95</b>
<b>S33372</b>	92mm x 7mm Miniature 54 (25B)	EACH	<b>£15.95</b>
<b>S1652</b>	100mm x 7mm Electric W865/945/955	EACH	<b>£15.95</b>
<b>S33409</b>	100.5mm x 7.5mm Miniature 71 (47)	EACH	<b>£15.95</b>

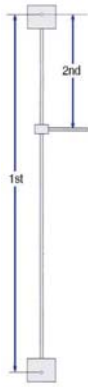
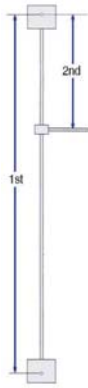

<b>S33410</b>	100.5mm x 7.5mm Electronic 75 (53A)	EACH	<b>£15.95</b>
<b>S33371</b>	131mm x 13mm Standard 53 (25A)	EACH	<b>£15.95</b>

**Kaiser**

Suspension Unit - Kaiser

Dimensions:

- 1st = Distance between upper and lower fixing (pinning) points
- 2nd = Distance between upper fixing (pinning) point and fork / pin line

Listed as:

- 1st x 2nd x Model x (Horolovar No. in Brackets)

Kaiser Models:

- 113mm x 9mm, Standard 54 (34)

Click website "More Information" for additional specification

Code	Description	UOM	Price
<b>S33379</b>	113mm x 9mm Standard 54 (34)	EACH	<b>£15.95</b>

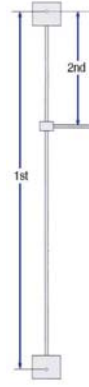

**Kern**

Suspension Unit - Kern

Dimensions:

- 1st = Distance between upper and lower fixing (pinning) points
- 2nd = Distance between upper fixing (pinning) point and fork / pin line

Listed as:

- 1st x 2nd x Model x (Horolovar No. in Brackets)

Kern Models:

- 79mm x 7mm, Midget 58 Picollo (12E)
- 82.5mm x 26mm, Miniature 77 (58) Electric
- 82.5mm x 28mm, Miniature 75 (56) Electric
- 86mm x 7mm, Miniature 57 (12C)
- 86mm x 7.5mm, Miniature 58 (12D)
- 86mm x 8mm, Miniature 61 (12F)
- 101mm x 26mm, Standard 77 (57)
- 102mm x 27mm, Standard 75 (55) Electric
- 103.2mm x 26mm, Miniature 78 (59)
- 128.6mm x 13mm, Standard 50 (11A)
- 132.5mm x 13mm, Standard 54 (11B)

Click website "More Information" for additional specification

Code	Description	UOM	Price
<b>S1648</b>	79mm x 7mm Midget 58 (12E)	EACH	<b>£16.25</b>
<b>S1650</b>	82.5mm x 26mm Miniature 77 (58)	EACH	<b>£10.25</b>
<b>S1651</b>	82.5mm x 28mm Miniature 75 (56)	EACH	<b>£10.25</b>
<b>S33397</b>	86mm x 7mm Miniature 57 (12C)	EACH	<b>£14.95</b>
<b>S1647</b>	86mm x 7.5mm Miniature 58 (12D)	EACH	<b>£12.25</b>
<b>S1646</b>	86mm x 8mm Miniature 61 (12F)	EACH	<b>£16.50</b>
<b>S33414</b>	101mm x 26mm Standard 77 (57)	EACH	<b>£10.25</b>
<b>S1649</b>	102mm x 27mm Standard 75 (55)	EACH	<b>£10.25</b>
<b>S33415</b>	103.2mm x 26mm Miniature 78 (59)	EACH	<b>£10.25</b>
<b>S1645</b>	128.6mm x 13mm Standard 50 (11A)	EACH	<b>£10.25</b>
<b>S33396</b>	132.5mm x 13mm Standard 54 (11B)	EACH	<b>£10.25</b>

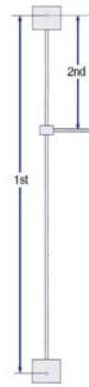

**Koma (Master)**

Suspension Unit - Koma (Master)

Dimensions:

- 1st = Distance between upper and lower fixing (pinning) points
- 2nd = Distance between upper fixing (pinning) point and fork / pin line

Listed as:

- 1st x 2nd x Model x (Horolovar No. in Brackets)

Koma (Master) Models:

- 61.6mm x 17.3mm, Miniature 80 (66A)
- 73mm x 8mm, Midget 73 (38A)
- 85mm x 11mm, New Master 100 Day (46)
- 103mm x 47.5mm, Master 75 (60B)
- 107mm x 23.5mm, Master 77 (61B)
- 111mm x 9mm, Miniature 54 (14A)
- 111mm x 9mm, Miniature 65 (14B)
- 119mm x 12mm, Master Standard 55 (41B)
- 120mm x 10.5mm, Master Standard 70 (45A)
- 124mm x 9.5mm, Standard 56 (13C)
- 124mm x 10mm, Standard 52 (13B)

Click website "More Information" for additional specification

Code	Description	UOM	Price
<b>S33408</b>	61.6mm x 17.3mm Miniature 80 (66A)	EACH	<b>£19.95</b>
<b>S6589</b>	73mm x 8mm Midget 73 (38A)	EACH	<b>£19.95</b>
<b>S33403</b>	85mm x 11mm New Master 100 Day (46)	EACH	<b>£19.95</b>
<b>S33388</b>	103mm x 47.5mm Master 75 (60B)	EACH	<b>£19.95</b>
<b>S33389</b>	107mm x 23.5mm Master 77 (61B)	EACH	<b>£19.95</b>
<b>S6588</b>	111mm x 9mm Miniature 54 (14A)	EACH	<b>£19.95</b>
<b>S6587</b>	111mm x 9mm Koma Miniature 65 (14B) Mechanical	EACH	<b>£19.95</b>
<b>S33401</b>	119mm x 12mm Master Standard 55 (41B)	EACH	<b>£19.95</b>
<b>S33402</b>	120mm x 10.5mm Master Standard 70 (45A)	EACH	<b>£19.95</b>
<b>S33387</b>	124mm x 9.5mm Standard 56 (13C)	EACH	<b>£19.95</b>
<b>S6586</b>	124mm x 10mm Standard 52 (13B)	EACH	<b>£19.95</b>

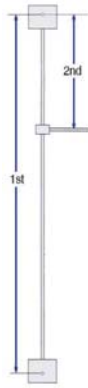

**Kundo**

Suspension Unit - Kundo

Dimensions:

- 1st = Distance between upper and lower fixing (pinning) points
- 2nd = Distance between upper fixing (pinning) point and fork / pin line

Listed as:

- 1st x 2nd x Model x (Horolovar No. in Brackets)

Kundo Models:

- 74mm x 9mm, Midget 58 (5F)
- 83mm x 25mm, Miniature 76 (63B)
- 92.8mm x 7.5mm, Junior 56 (5E)
- 93mm x 20mm, Miniature 57 (52B)
- 93mm x 25mm, Miniature 73 (49B)
- 97mm x 19mm, Master Standard 75 (50B)
- 111mm x 21mm, Standard 73 (48B)
- 112.5mm x 20mm, Standard 77 (51A)
- 112.5mm x 20mm, Standard 77 (51B)
- 126mm x 13mm, Standard 55 (3C)
- 126mm x 14mm, Standard 53 (3A)
- 126mm x 14.6mm, Standard 54 (3B)
- 126.3mm x 14.8mm, Standard 49 (1)





Click website "More Information" for additional specification

Code	Description	UOM	Price
<b>S1638</b>	74mm x 9mm Midget 58 (5F)	EACH	<b>£17.50</b>
<b>S33390</b>	83mm x 25mm Miniature 76 (63B)	EACH	<b>£17.50</b>
<b>S33394</b>	92.8mm x 7.5mm Junior 56 (5E)	EACH	<b>£17.50</b>
<b>S33407</b>	93mm x 20mm Miniature 57 (52B)	EACH	<b>£17.50</b>
<b>S1643</b>	93mm x 25mm Miniature 73 (49B)	EACH	<b>£17.50</b>
<b>S33405</b>	97mm x 19mm Master Standard 75 (50B)	EACH	<b>£17.50</b>
<b>S33404</b>	111mm x 21mm Standard 73 (48B)	EACH	<b>£17.50</b>
<b>S1642</b>	112.5mm x 20mm Standard 77 (51A)	EACH	<b>£17.50</b>
<b>S1640</b>	112.5mm x 20mm Kundo Standard 77 (51B) Electric	EACH	<b>£17.50</b>
<b>S1637</b>	126mm x 13mm Standard 55 (3C)	EACH	<b>£17.50</b>
<b>S33392</b>	126mm x 14mm Standard 53 (3A)	EACH	<b>£17.50</b>
<b>S33393</b>	126mm x 14.6mm Standard 54 (3B)	EACH	<b>£17.50</b>
<b>S33391</b>	126.3mm x 14.8mm Standard 49 (1)	EACH	<b>£17.50</b>

**Link**

Suspension Unit - Link

Dimensions:

- 1st = Distance between upper and lower fixing (pinning) points
- 2nd = Distance between upper fixing (pinning) point and fork / pin line

Listed as:

- 1st x 2nd x Model x (Horolovar No. in Brackets)

Link Models:

- 96mm x 7mm, Miniature 56 (35)
- 126mm x 11mm, Standard 52 (16)

Click website "More Information" for additional specification

Code	Description	UOM	Price
<b>S33381</b>	96mm x 7mm Miniature 56 (35)	EACH	<b>£15.95</b>
<b>S33380</b>	126mm x 11mm Standard 52 (16)	EACH	<b>£15.95</b>

**Neueck (Wilmac)**

Suspension Unit - Neueck (Wilmac)

Dimensions:

- 1st = Distance between upper and lower fixing (pinning) points
- 2nd = Distance between upper fixing (pinning) point and fork / pin line

Listed as:

- 1st x 2nd x Model x (Horolovar No. in Brackets)

Neueck (Wilmac) Models:

- 119mm x 9mm, Neueck 57 (27C)

Click website "More Information" for additional specification

Code	Description	UOM	Price
<b>S33400</b>	119mm x 9mm Neueck 57 (27C)	EACH	<b>£15.95</b>

**Petersen**

Suspension Unit - Petersen

Dimensions:

- 1st = Distance between upper and lower fixing (pinning) points
- 2nd = Distance between upper fixing (pinning) point and fork / pin line

Listed as:

- 1st x 2nd x Model x (Horolovar No. in Brackets)

Petersen Models:

- 121mm x 12mm, Standard 55 (36B)
- 130mm x 13mm, Standard 53 (18C)

Click website "More Information" for additional specification

Code	Description	UOM	Price
<b>S33383</b>	121mm x 12mm Standard 55 (36B)	EACH	<b>£15.95</b>
<b>S33382</b>	130mm x 13mm Standard 53 (18C)	EACH	<b>£15.95</b>

**Reiner**

Suspension Unit - Reiner

Dimensions:

- 1st = Distance between upper and lower fixing (pinning) points
- 2nd = Distance between upper fixing (pinning) point and fork / pin line

Listed as:

- 1st x 2nd x Model x (Horolovar No. in Brackets)

Reiner Models:

- 112mm x 12mm, Standard 56 (23B)
- 112mm x 13mm, Standard 53 (24)
- 113mm x 13mm, Standard 53 (23A)

Click website "More Information" for additional specification

Code	Description	UOM	Price
<b>S33385</b>	112mm x 12mm Standard 56 (23B)	EACH	<b>£15.95</b>
<b>S33386</b>	112mm x 13mm Standard 53 (24)	EACH	<b>£15.95</b>
<b>S33384</b>	113mm x 13mm Standard 53 (23A)	EACH	<b>£15.95</b>

**Schatz**

Suspension Unit - Schatz

Dimensions:

- 1st = Distance between upper and lower fixing (pinning) points
- 2nd = Distance between upper fixing (pinning) point and fork / pin line

Listed as:

- 1st x 2nd x Model x (Horolovar No. in Brackets)

Schatz Models:

- 68.5mm x 7.5mm, Midget 57 (10C)
- 92mm x 5.5mm, Miniature 53 (10A)
- 120mm x 11.5mm, Standard 49 to 54 (9 & 6789)
- 128.6mm x 13mm, Miniature 53 (10A)

Click website "More Information" for additional specification

Code	Description	UOM	Price
<b>S1665</b>	68.5mm x 7.5mm Midget 57 (10C)	EACH	<b>£19.85</b>
<b>S1664</b>	92mm x 5.5mm Miniature 53 (10A)	EACH	<b>£19.85</b>
<b>S1663</b>	120mm x 11.5mm Standard 54 (9)	EACH	<b>£19.85</b>
<b>S33395</b>	128.6mm x 13mm Miniature 53 (10A)	EACH	<b>£19.85</b>



**Anniversary (400 Day) By Size**

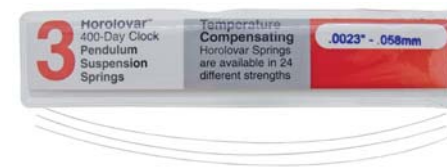

Suspension Springs - Horolovar - By Size

- Horolovar
- 400 Day
- Anniversary Clocks
- 3 or 12 pieces per size
- Temperature compensating wires
- Made from Ni-span 'c' alloy for improve time keeping
- Made in U.S.A.

Sizes:

- 0.0018" (0.046mm) - 0.0019" (0.048mm)
- 0.0020" (0.051mm) - 0.0021" (0.053mm)
- 0.0022" (0.056mm) - 0.0023" (0.058mm)
- 0.0024" (0.061mm) - 0.0025" (0.064mm)
- 0.0028" (0.071mm) - 0.0030" (0.076mm)
- 0.0031" (0.079mm) - 0.0032" (0.081mm)
- 0.0033" (0.084mm) - 0.0034" (0.086mm)
- 0.0035" (0.089mm) - 0.0036" (0.091mm)
- 0.0037" (0.094mm) - 0.0038" (0.097mm)
- 0.0040" (0.102mm) - 0.0045" (0.114mm)
- 0.0050" (0.127mm) - 0.0055" (0.140mm)
- 0.0060" (0.152mm)

Length: 140mm

(\*XL = 200mm)

Code	Description	UOM	Price
<b>S5033</b>	0.0018" (0.046mm) Horolovar	PACK*3	<b>£4.90</b>
<b>S5034</b>	0.0019" (0.048mm) Horolovar	PACK*3	<b>£4.90</b>
<b>S5035</b>	0.0020" (0.051mm) Horolovar	PACK*3	<b>£4.90</b>
<b>S5036</b>	0.0021" (0.053mm) Horolovar	PACK*3	<b>£4.90</b>
<b>S5037</b>	0.0022" (0.056mm) Horolovar	PACK*3	<b>£4.90</b>
<b>S5038</b>	0.0023" (0.058mm) Horolovar	PACK*3	<b>£4.90</b>
<b>S7699</b>	0.00235" (0.060mm) Swiss (*XL)	PACK*12	<b>£14.95</b>
<b>S5039</b>	0.0024" (0.061mm) Horolovar	PACK*3	<b>£4.90</b>
<b>S5040</b>	0.0025" (0.064mm) Horolovar	PACK*3	<b>£4.90</b>
<b>S5041</b>	0.0028" (0.071mm) Horolovar	PACK*3	<b>£4.90</b>
<b>S5042</b>	0.0030" (0.076mm) Horolovar	PACK*3	<b>£4.90</b>
<b>S5043</b>	0.0031" (0.079mm) Horolovar	PACK*3	<b>£4.90</b>
<b>S5044</b>	0.0032" (0.081mm) Horolovar	PACK*3	<b>£4.90</b>
<b>S5045</b>	0.0033" (0.084mm) Horolovar	PACK*3	<b>£4.90</b>
<b>S5046</b>	0.0034" (0.086mm) Horolovar	PACK*3	<b>£4.90</b>
<b>S5047</b>	0.0035" (0.089mm) Horolovar	PACK*3	<b>£4.90</b>
<b>S5048</b>	0.0036" (0.091mm) Horolovar	PACK*3	<b>£4.90</b>
<b>S5049</b>	0.0037" (0.094mm) Horolovar	PACK*3	<b>£4.90</b>
<b>S5050</b>	0.0038" (0.097mm) Horolovar	PACK*3	<b>£4.90</b>
<b>S5051</b>	0.0040" (0.102mm) Horolovar	PACK*3	<b>£4.90</b>
<b>S5052</b>	0.0045" (0.114mm) Horolovar	PACK*12	<b>£17.50</b>
<b>S5053</b>	0.0050" (0.127mm) Horolovar	PACK*12	<b>£17.50</b>
<b>S5054</b>	0.0055" (0.140mm) Horolovar	PACK*12	<b>£17.50</b>
<b>S5055</b>	0.0060" (0.152mm) Horolovar	PACK*12	<b>£17.50</b>

Price breaks available, see website



**Anniversary (400 Day) "Popular" Set**

Suspension Springs - Horolovar - Popular Set

- Horolovar
- 400 Day
- Graded by Size in Partitioned Wallet
- Popular Set
- Pack of 12
- Made in U.S.A.

- Sizes:
- 0.0020" (0.051mm)
  - 0.0023" (0.058mm) x 2
  - 0.0025" (0.064mm)
  - 0.0030" (0.076mm)
  - 0.0032" (0.081mm) x 2
  - 0.0035" (0.089mm) x 2
  - 0.0037" (0.094mm)
  - 0.0040" (0.102mm) x 2

Length: 140mm

Code	Description	UOM	Price
S5056	Popular Horolovar Set	PACK*12	£18.40



**Anniversary (400 Day) "Intermediate" Set**

Suspension Springs - Horolovar - Intermediate Set

- Horolovar
- 400 Day
- Graded by Size in Partitioned Wallet.
- Intermediate Set
- Pack of 12
- Made in U.S.A.

- Sizes:
- 0.0018" (0.046mm) - 0.0019" (0.048mm)
  - 0.0021" (0.053mm) - 0.0022" (0.056mm)
  - 0.0024" (0.061mm) - 0.0028" (0.071mm)
  - 0.0031" (0.079mm) - 0.0033" (0.084mm)
  - 0.0036" (0.091mm) - 0.0038" (0.097mm)
  - 0.0045" (0.114mm) - 0.0050" (0.127mm)

Length: 140mm

Code	Description	UOM	Price
S5057	Intermediate Horolovar Set	EACH	£15.95



**ANNIVERSARY 400 DAY SUSPENSION SPRINGS, BRONZE**

**Anniversary (400 Day) Bronze**



Suspension Springs - Bergeon - By Size

- Bergeon Swiss
- 400 Day
- Anniversary Clocks
- 10 pieces per size
- Bronze wires

- Sizes:
- Thickness: 0.03mm to 0.10mm
  - Width: 0.60mm

• Length: 130mm

Code	Description	UOM	Price
S7695	0.03mm Springs, Bergeon	PACK*10	£27.45
S7696	0.04mm Springs, Bergeon	PACK*10	£27.45
S7698	0.06mm Springs, Bergeon	PACK*10	£27.45
S7702	0.09mm Springs, Bergeon	PACK*10	£26.95

**ANNIVERSARY 400 DAY REPLACEMENT BLOCK & FORK FITTINGS**

**Anniversary (400 Day) Fittings**

Suspension Springs - Replacements Block & Fork Fittings

- Anniversary Clocks
- 400 Day
- Top Quality Fittings
- Blocks & Forks
- Brass with Blue Steel Screws
- Made in Germany

**Set (400 Day) Fittings**

- Top Quality Fittings
- Blocks & Forks
- Pack of 10 pieces



Code	Description	UOM	Price
S5499	Set (400 Day) Fittings	PACK*10	£19.95

**Set (400 Day) Fittings, Indian**



- Blocks & Forks
- Pack of 5 pieces

Code	Description	UOM	Price
S41161	Set (400 Day) Fittings, Indian	PACK*5	£4.95

**Block (6.0 x 5.0mm) with Hole**

- Block with Hole (Ø1.70mm)
- 6.0 x 5.0mm
- Made in Germany



Code	Description	UOM	Price
S1674	Block (6.0 x 5.0mm) with Hole	EACH	£4.95



**Block (6.0 x 5.0mm) with Pin**

- Block with Pin
- 6.0 x 5.0mm
- Made in Germany



Code	Description	UOM	Price
S1675	Block (6.0 x 5.0mm) with Pin	EACH	£4.95

**Block (8.0 x 6.0mm) with Hole**

- Block with Hole (Ø2.00mm)
- 8.0 x 6.0mm
- Made in Germany



Code	Description	UOM	Price
S1673	Block (8.0 x 6.0mm) with Hole	EACH	£4.95

**Block (8.0 x 6.0mm) with Pin**

- Block with Pin
- 8.0 x 6.0mm
- Made in Germany



Code	Description	UOM	Price
S1672	Block (8.0 x 6.0mm) with Pin	EACH	£4.95

**Block (8.0 x 7.5mm) with Hole**

- Block with Hole (Ø2.00mm)
- 8.0 x 7.5mm
- Made in Germany



Code	Description	UOM	Price
S1670	Block (8.0 x 7.5mm) with Hole	EACH	£4.95

**Block (8.0 x 7.5mm) with Pin**

- Block with Pin
- 8.0 x 7.5mm
- Made in Germany



Code	Description	UOM	Price
S1671	Block (8.0 x 7.5mm) with Pin	EACH	£4.95

**Fork (1 Pin) 14mm**

- Fork with 1 Pin
- 14mm Overall Length
- Made in German



Code	Description	UOM	Price
S32398	Fork (1 Pin) 14mm	EACH	£4.95

**Fork (2 Pin) 14mm**

- Fork with 2 Pins
- Short Pins
- 16mm Overall Length
- Made in German



Code	Description	UOM	Price
S32396	Fork (2 Pin) 14mm	EACH	£4.95

**Fork (2 Pin) 14mm, 2 Piece**

- Fork with 2 Pins, 2 Piece
- 16mm Overall Length
- Made in German



Code	Description	UOM	Price
S32397	Fork (2 Pin) 14mm, 2 Piece	EACH	£4.95

**Fork (2 Pin) 16mm**

- Fork with 2 Pins
- 16mm Overall Length
- Made in German



Code	Description	UOM	Price
S1676	Fork (2 Pin) 16mm	EACH	£4.95

**Assortments, Suspension Springs**

**French Clock Suspensions**

- Brass & Steel
- High Quality
- French Clocks
- 12 Pieces
- Made in Germany



Code	Description	UOM	Price
S1679	French Clock Suspensions	PACK*12	£40.95

**General Clock Suspensions**



- 100 pieces Economy pack
- Non EU Quality
- German & French Clock Suspensions
- Various Sizes
- Made in India

This assortment (S31270) is not high quality, this is a relatively inexpensive selection designed for very cheap basic clocks, the finish is not good and not all are manufactured perfectly.

Code	Description	UOM	Price
S31270	General Clock Suspensions	PACK*100	£21.95

**PENDULUM CLOCK SUSPENSION SPRINGS**

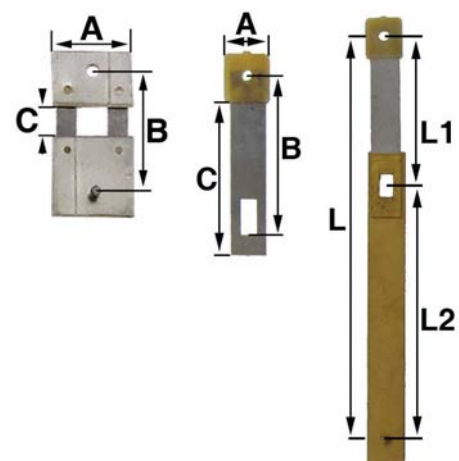

**German & European Clock Suspensions**

- Brass & Steel
- High Quality
- German & European Clocks
- 36 Pieces
- Made in Germany



Code	Description	UOM	Price
S1681	German & European Clock Suspensions	PACK*36	£73.50

**German Clock Suspensions**

- Brass & Steel
- High Quality
- German Clocks
- 12 Pieces
- Made in Germany



Code	Description	UOM	Price
S1680	German Clock Suspensions	PACK*12	£21.95

- Best Quality*
- French, German and European Clock Suspensions
  - Baduf
  - Bornholmer
  - Comtoiser
  - Gerb. Jauch
  - Haller
  - Hermle
  - Kieninger
  - Kundo
  - SBS
  - Seth Thomas
  - Urgos
  - Warmink
  - Zaans

Will fit many more branded and unbranded Clocks

**German Clock Suspensions, Larger Sizes**

- Brass & Steel
- High Quality
- German Clocks
- Larger Sizes
- 12 Pieces
- Made in Germany



Code	Description	UOM	Price
S1677	German Clock Suspensions, Larger Sizes	PACK*12	£41.45

**by Size: B = 9.0mm to 12.5mm**

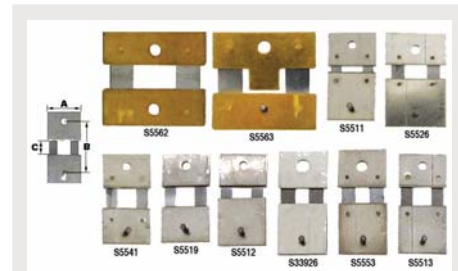

Suspension Springs - B = 9.0mm to 12.5mm

- Brass & Steel
- High Quality
- For Pendulum Clocks

Dimensions: B x A x C  
 • A = Width  
 • B = Distance Between Pinning Points  
 • C = Actual Spring Length

**B = 10.0mm (A = 17.0mm & C = 3.9mm) Kundo**

- B = 10.0mm
- A = 17.0mm
- C = 3.9mm

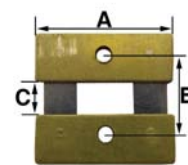

Code	Description	UOM	Price
S5562	B = 10.0mm (A = 17.0mm & C = 3.9mm) Kundo	EACH	£8.95

**B = 10.0mm (A = 17.0mm & C = 3.8mm) Kundo**

- B = 10.0mm
- A = 17.0mm
- C = 3.8mm

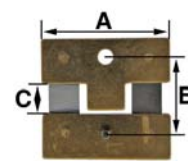

Code	Description	UOM	Price
S5563	B = 10.0mm (A = 17.0mm & C = 3.8mm) Kundo	EACH	£9.50

**www. Online Discounts**

**CUSTOMER SERVICE SECOND TO NONE**

**TODAY SAME DAY DISPATCH**

**Hermle Suspension Springs**

See Page 1290

# SUSPENSIONS

**B = 10.5mm (A = 8.0mm & C = 1.0mm)**

- B = 10.5mm
- A = 8.0mm
- C = 1.0mm

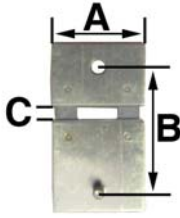

Code	Description	UOM	Price
S5511	B = 10.5mm (A = 8.0mm & C = 1.0mm)	EACH	£2.50

**B = 12.0mm (A = 8.0mm & C = 2.3mm) Kieninger**

- B = 12.0mm
- A = 8.0mm
- C = 2.3mm

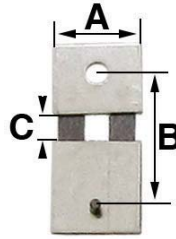

Code	Description	UOM	Price
S33926	B = 12.0mm (A = 8.0mm & C = 2.3mm) Kieninger	EACH	£2.50

**B = 13.0mm (A = 8.0mm & C = 2.8mm)**

- B = 13.0mm
- A = 8.0mm
- C = 2.8mm

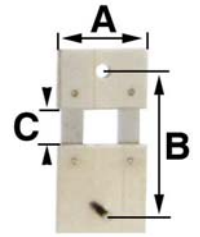

Code	Description	UOM	Price
S5543	B = 13.0mm (A = 8.0mm & C = 2.8mm)	EACH	£2.50

**B = 11.0mm (A = 10.0mm & C = 2.2mm)**

- B = 11.0mm
- A = 10.0mm
- C = 2.2mm

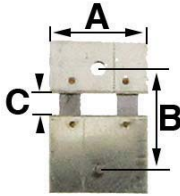

Code	Description	UOM	Price
S5526	B = 11.0mm (A = 10.0mm & C = 2.2mm)	EACH	£2.50

**B = 12.5mm (A = 8.0mm & C = 2.5mm) Hermle**

- B = 12.5mm
- A = 8.0mm
- C = 2.5mm

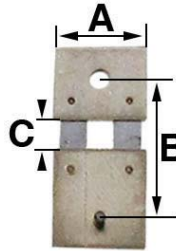

Code	Description	UOM	Price
S5553	B = 12.5mm (A = 8.0mm & C = 2.5mm) Hermle	EACH	£2.50

**B = 13.0mm (A = 8.0mm & C = 3.0mm)**

- B = 13.0mm
- A = 8.0mm
- C = 3.0mm

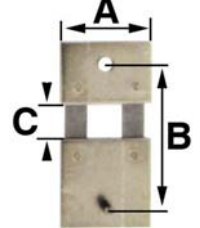

Code	Description	UOM	Price
S7694	B = 13.0mm (A = 8.0mm & C = 3.0mm)	EACH	£1.70

**B = 11.0mm (A = 8.0mm & C = 3.2mm)**

- B = 11.0mm
- A = 8.0mm
- C = 3.2mm

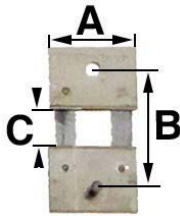

Code	Description	UOM	Price
S5541	B = 11.0mm (A = 8.0mm & C = 3.2mm)	EACH	£2.25

**B = 12.5mm (A = 8.0mm & C = 2.7mm)**

- B = 12.5mm
- A = 8.0mm
- C = 2.7mm

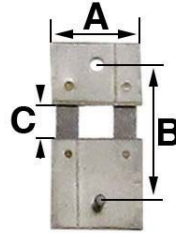

Code	Description	UOM	Price
S5513	B = 12.5mm (A = 8.0mm & C = 2.7mm)	EACH	£2.50

**B = 13.0mm (A = 8.0mm & C = 3.1mm)**

- B = 13.0mm
- A = 8.0mm
- C = 3.1mm

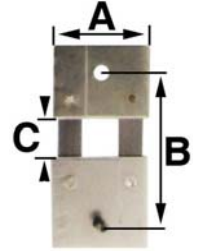

Code	Description	UOM	Price
S5520	B = 13.0mm (A = 8.0mm & C = 3.1mm)	EACH	£1.70

**B = 11.0mm (A = 8.0mm & C = 3.6mm)**

- B = 11.0mm
- A = 8.0mm
- C = 3.6mm

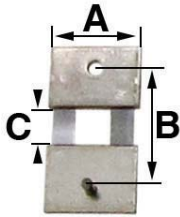

Code	Description	UOM	Price
S5519	B = 11.0mm (A = 8.0mm & C = 3.6mm)	EACH	£2.30

**by Size: B = 13.0mm to 14.0mm**



Suspension Springs - B = 13.0mm to 14.5mm

- Brass & Steel
  - High Quality
  - For Pendulum Clocks
- Dimensions: B x A x C
- A = Width
  - B = Distance Between Pinning Points
  - C = Actual Spring Length

**B = 13.0mm (A = 8.0mm & C = 3.3mm)**

- B = 13.0mm
- A = 8.0mm
- C = 3.3mm

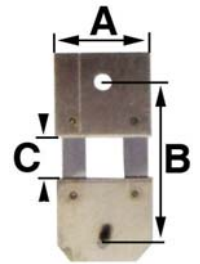

Code	Description	UOM	Price
S5544	B = 13.0mm (A = 8.0mm & C = 3.3mm)	EACH	£2.75

**B = 11.5mm (A = 8.0mm & C = 1.6mm)**

- B = 11.5mm
- A = 8.0mm
- C = 1.6mm

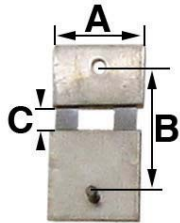

Code	Description	UOM	Price
S5512	B = 11.5mm (A = 8.0mm & C = 1.6mm)	EACH	£2.50

**B = 13.0mm (A = 8.0mm & C = 3.6mm)**

- B = 13.0mm
- A = 8.0mm
- C = 3.6mm

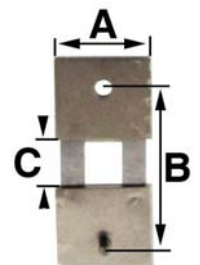

Code	Description	UOM	Price
S5542	B = 13.0mm (A = 8.0mm & C = 3.6mm)	EACH	£1.70

**WORLDWIDE DELIVERY**

**PRICE PROMISE GUARANTEE**

**B = 13.0mm (A = 8.0mm & C = 4.0mm)**

- B = 13.0mm
- A = 8.0mm
- C = 4.0mm
- Round Blocks

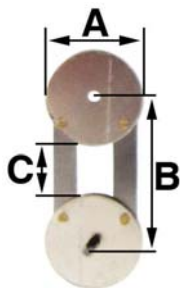

Code	Description	UOM	Price
S5523	B = 13.0mm (A = 8.0mm & C = 4.0mm)	EACH	£4.75

**B = 14.0mm (A = 8.0mm & C = 4.0mm)**

- B = 14.0mm
- A = 8.0mm
- C = 4.0mm

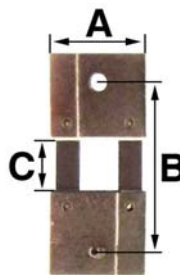

Code	Description	UOM	Price
S5518	B = 14.0mm (A = 8.0mm & C = 4.0mm)	EACH	£1.70

**B = 14.5mm (A = 8.0mm & C = 4.8mm)**

- B = 14.5mm
- A = 8.0mm
- C = 4.8mm

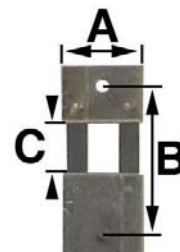

Code	Description	UOM	Price
S5515	B = 14.5mm (A = 8.0mm & C = 4.8mm)	EACH	£1.95

**B = 13.0mm (A = 8.0mm & C = 4.0mm)**

- B = 13.0mm
- A = 8.0mm
- C = 4.0mm
- Hermle, Urgos

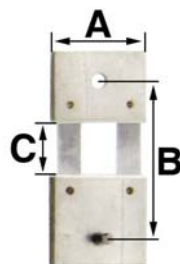

Code	Description	UOM	Price
S33919	B = 13.0mm (A = 8.0mm & C = 4.0mm)	EACH	£3.65

**B = 14.0mm (A = 10.0mm & C = 3.0mm)**

- B = 14.0mm
- A = 10.0mm
- C = 3.0mm

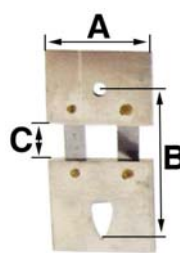

B = Top hole to Bottom of the Oval

Code	Description	UOM	Price
S5530	B = 14.0mm (A = 10.0mm & C = 3.0mm)	EACH	£2.75

**B = 15.0mm (A = 5.0mm & C = 8.0mm)**

- B = 15.0mm
- A = 5.0mm
- C = 8.0mm

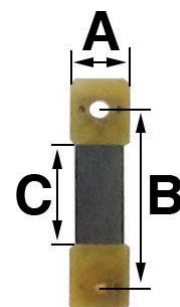

Code	Description	UOM	Price
S5540	B = 15.0mm (A = 5.0mm & C = 8.0mm)	EACH	£1.95

**B = 13.0mm (A = 10.0mm & C = 4.0mm)**

- B = 13.0mm
- A = 10.0mm
- C = 4.0mm

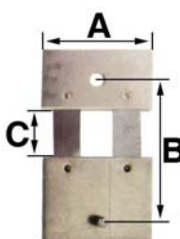

Code	Description	UOM	Price
S5527	B = 13.0mm (A = 10.0mm & C = 4.0mm)	EACH	£1.95

**by Size: B = 14.5mm to 15.5mm**



Suspension Springs - B = 14.50mm to 15.5mm

- Brass & Steel
- High Quality
- For Pendulum Clocks

Dimensions: B x A x C

- A = Width
- B = Distance Between Pinning Points
- C = Actual Spring Length

**B = 15.0mm (A = 5.0mm & C = 9.0mm)**

- B = 15.0mm
- A = 5.0mm
- C = 9.0mm

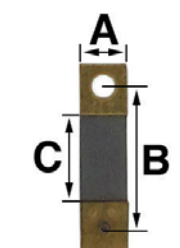

Code	Description	UOM	Price
S33929	B = 15.0mm (A = 5.0mm & C = 9.0mm)	EACH	£4.95

**B = 13.5mm (A = 8.0mm & C = 3.8mm)**

- B = 13.5mm
- A = 8.0mm
- C = 3.8mm

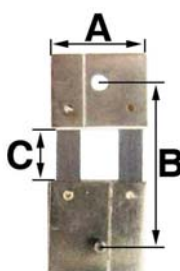

Code	Description	UOM	Price
S5524	B = 13.5mm (A = 8.0mm & C = 3.8mm)	EACH	£2.50

**B = 14.5mm (A = 8.0mm & C = 4.0mm)**

- B = 14.5mm
- A = 8.0mm
- C = 4.0mm

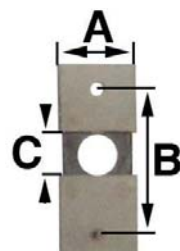

Code	Description	UOM	Price
S33917	B = 14.5mm (A = 8.0mm & C = 4.0mm)	EACH	£2.95

**B = 15.0mm (A = 8.0mm & C = 4.2mm)**

- B = 15.0mm
- A = 8.0mm
- C = 4.2mm

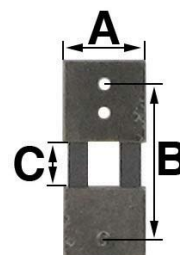

B = Pin to Top Hole

Code	Description	UOM	Price
S33918	B = 15.0mm (A = 8.0mm & C = 4.2mm)	EACH	£2.95

**B = 14.0mm (A = 8.0mm & C = 3.5mm)**

- B = 14.0mm
- A = 8.0mm
- C = 3.5mm

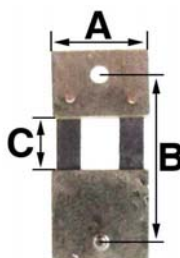

Code	Description	UOM	Price
S5514	B = 14.0mm (A = 8.0mm & C = 3.5mm)	EACH	£1.70

**B = 15.0mm (A = 8.0mm & C = 4.2mm)**

- B = 15.0mm
- A = 8.0mm
- C = 4.2mm

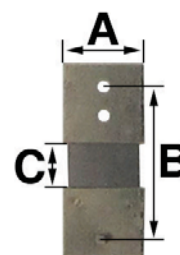

B = Pin to Top Hole, Solid Spring

Code	Description	UOM	Price
S33920	B = 15.0mm (A = 8.0mm & C = 4.2mm)	EACH	£2.95



**B = 15.0mm (A = 10mm & C = 3.0mm)**

- B = 15.0mm
- A = 10.0mm
- C = 3.0mm

B = Top hole to Bottom of the Oval

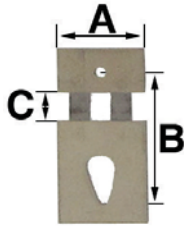

Code	Description	UOM	Price
S5531	B = 15.0mm (A = 10mm & C = 3.0mm)	EACH	£1.95

**B = 15.0mm (A = 12mm & C = 5.2mm)**

- B = 15.0mm
- A = 12.0mm
- C = 5.2mm

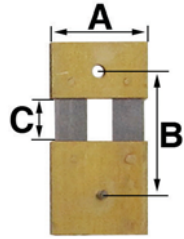

Code	Description	UOM	Price
S33925	B = 15.0mm (A = 12mm & C = 5.2mm)	EACH	£5.95

**B = 15.5mm (A = 4.0mm & C = 8.3mm)**

- B = 15.5mm
- A = 4.0mm
- C = 8.3mm

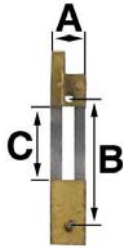

Code	Description	UOM	Price
S5559	B = 15.5mm (A = 4.0mm & C = 8.3mm)	EACH	£4.15

**B = 15.5mm (A = 5.0mm & C = 8.5mm)**

- B = 15.5mm
- A = 5.0mm
- C = 8.5mm

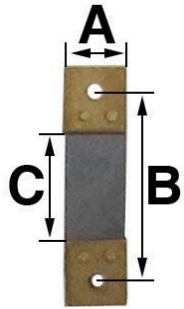

Code	Description	UOM	Price
S33930	B = 15.5mm (A = 5.0mm & C = 8.5mm)	EACH	£3.95

**B = 15.5mm (A = 8.0mm & C = 2.5mm)**

- B = 15.5mm
- A = 8.0mm
- C = 2.5mm

B = Top hole to Bottom of the Oval

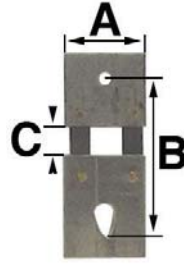

Code	Description	UOM	Price
S5529	B = 15.5mm (A = 8.0mm & C = 2.5mm)	EACH	£1.95

**B = 15.5mm (A = 12mm & C = 4.2mm)**

- B = 15.5mm
- A = 12.0mm
- C = 4.2mm

Extra Pinning Hole, Hermle, Kieninger

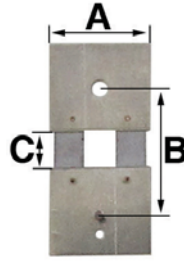

Code	Description	UOM	Price
S33923	B = 15.5mm (A = 12mm & C = 4.2mm)	EACH	£4.95

**B = 15.5mm (A = 12mm & C = 4.2mm) Hermle, Kieninger**

- B = 15.5mm
- A = 12.0mm
- C = 4.2mm

Hermle, Kieninger

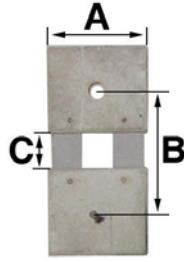

Code	Description	UOM	Price
S33924	B = 15.5mm (A = 12mm & C = 4.2mm) Hermle, Kieninger	EACH	£4.95

**B = 15.5mm (A = 14mm & C = 6.5mm)**

- B = 15.5mm
- A = 14.0mm
- C = 6.5mm

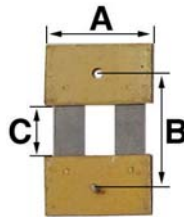

Code	Description	UOM	Price
S33939	B = 15.5mm (A = 14mm & C = 6.5mm)	EACH	£5.95

**by Size: B = 16mm to 17mm**

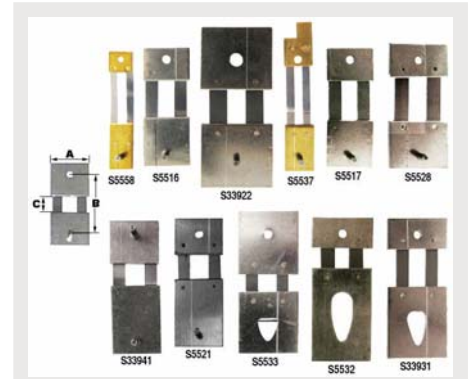

Suspension Springs - B = 16mm to 17mm

- Brass & Steel
- High Quality
- For Pendulum Clocks

Dimensions: B x A x C

- A = Width
- B = Distance Between Pinning Points
- C = Actual Spring Length

**B = 16.0mm (A = 4.0mm & C = 8.5mm)**

- B = 16.0mm
- A = 4.0mm
- C = 8.5mm

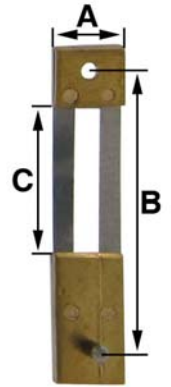

Code	Description	UOM	Price
S5558	B = 16.0mm (A = 4.0mm & C = 8.5mm)	EACH	£3.75

**B = 16.0mm (A = 8.0mm & C = 6.0mm)**

- B = 16.0mm
- A = 8.0mm
- C = 6.0mm

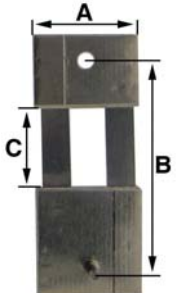

Code	Description	UOM	Price
S5516	B = 16.0mm (A = 8.0mm & C = 6.0mm)	EACH	£2.45

**B = 16.0mm (A = 12mm & C = 5.5mm)**

- B = 16.0mm
- A = 12.0mm
- C = 5.5mm

Gebr. Jauch

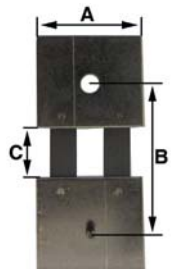

Code	Description	UOM	Price
S33922	B = 16.0mm (A = 12mm & C = 5.5mm)	EACH	£4.15



Long Nose Pliers for Extra Reach



See Page 946

Steel Pins

See Page 1346



**B = 16.5mm (A = 5.0mm & C = 9.5mm)**

- B = 16.5mm
- A = 5.0mm
- C = 9.5mm

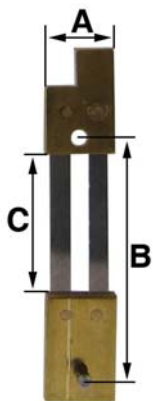

Code	Description	UOM	Price
S5537	B = 16.5mm (A = 5.0mm & C = 9.5mm)	EACH	£2.95

**• B = 16.5mm**

**• A = 8.0mm**

**• C = 6.3mm**

- B = 16.5mm
- A = 8.0mm
- C = 6.3mm

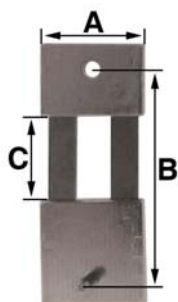

Code	Description	UOM	Price
S5517	• B = 16.5mm • A = 8.0mm • C = 6.3mm	EACH	£2.30

**B = 16.5mm (A = 10mm & C = 7.8mm)**

- B = 16.5mm
- A = 10.0mm
- C = 7.8mm

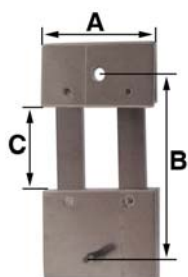

Code	Description	UOM	Price
S5528	B = 16.5mm (A = 10mm & C = 7.8mm)	EACH	£2.30

**B = 17.0mm (A = 8.0mm & C = 3.3mm)**

- B = 17.0mm
- A = 8.0mm
- C = 3.3mm

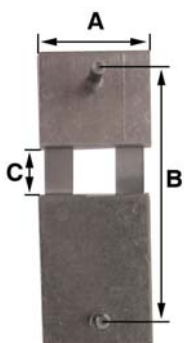

Code	Description	UOM	Price
S33941	B = 17.0mm (A = 8.0mm & C = 3.3mm)	EACH	£2.95

**B = 17.0mm (A = 8.0mm & C = 4.0mm)**

- B = 17.0mm
- A = 8.0mm
- C = 4.0mm

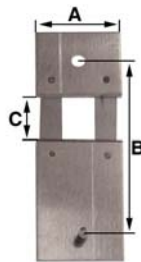

Code	Description	UOM	Price
S5521	B = 17.0mm (A = 8.0mm & C = 4.0mm)	EACH	£2.10

**B = 17.0mm (A = 10mm & C = 2.5mm)**

- B = 17.0mm
- A = 10.0mm
- C = 2.5mm

B = Top hole to Bottom of the Oval

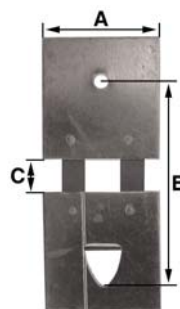

Code	Description	UOM	Price
S5533	B = 17.0mm (A = 10mm & C = 2.5mm)	EACH	£2.10

**B = 17.0mm (A = 10mm & C = 3.0mm)**

- B = 17.0mm
- A = 10.0mm
- C = 3.0mm

B = Top hole to Bottom of the Oval

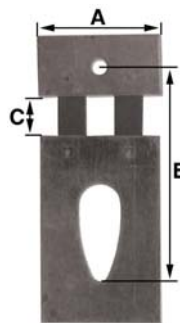

Code	Description	UOM	Price
S5532	B = 17.0mm (A = 10mm & C = 3.0mm)	EACH	£2.10

**B = 17.0mm (A = 10mm & C = 6.0mm)**

- B = 17.0mm
- A = 10.0mm
- C = 6.0mm

B = Top hole to Bottom of the Oval, Urgos

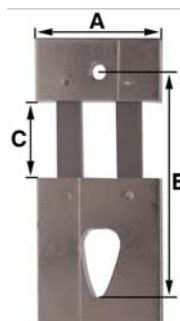

Code	Description	UOM	Price
S33931	B = 17.0mm (A = 10mm & C = 6.0mm)	EACH	£3.95

**by Size: B = 17.5mm to 19mm**

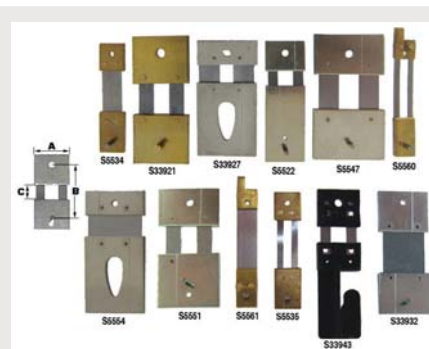

Suspension Springs - B = 17.5mm to 19mm

- Brass & Steel
- High Quality
- For Pendulum Clocks

Dimensions: B x A x C

- A = Width
- B = Distance Between Pinning Points
- C = Actual Spring Length

**B = 17.5mm (A = 5.0mm & C = 8.8mm)**

- B = 17.5mm
- A = 5.0mm
- C = 8.8mm

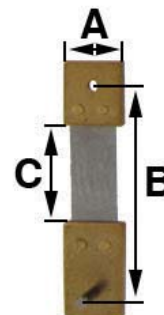

Code	Description	UOM	Price
S5534	B = 17.5mm (A = 5.0mm & C = 8.8mm)	EACH	£2.80

**B = 17.5mm (A = 11mm & C = 6.0mm)**

- B = 17.5mm
- A = 11.0mm
- C = 6.0mm

Urgos

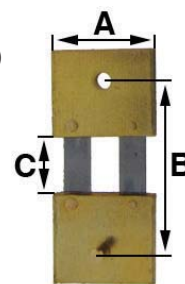

Code	Description	UOM	Price
S33921	B = 17.5mm (A = 11mm & C = 6.0mm)	EACH	£5.95

**B = 18.0mm (A = 12mm & C = 4.0mm)**

- B = 18.0mm
- A = 12.0mm
- C = 4.0mm

B = Top hole to Bottom of the Oval, Comtoiser

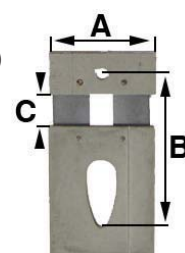

Code	Description	UOM	Price
S33927	B = 18.0mm (A = 12mm & C = 4.0mm)	EACH	£6.95

**PRICE PROMISE GUARANTEE**

# SUSPENSIONS

**B = 18.0mm (A = 8.0mm & C = 2.8mm)**

- B = 18.0mm
- A = 8.0mm
- C = 2.8mm

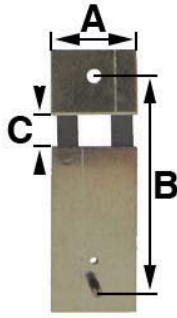

Code	Description	UOM	Price
S5522	B = 18.0mm (A = 8.0mm & C = 2.8mm)	EACH	£2.10

**B = 18.0mm (A = 14mm & C = 6.8mm)**

- B = 18.0mm
- A = 14.0mm
- C = 6.8mm

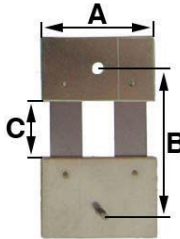

Code	Description	UOM	Price
S5547	B = 18.0mm (A = 14mm & C = 6.8mm)	EACH	£4.45

**B = 18.5mm (A = 4.0mm & C = 11.5mm)**

- B = 18.5mm
- A = 4.0mm
- C = 11.5mm

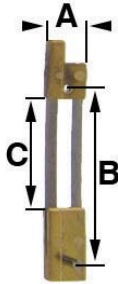

Code	Description	UOM	Price
S5560	B = 18.5mm (A = 4.0mm & C = 11.5mm)	EACH	£3.65

**B = 18.5mm (A = 12mm & C = 4.0mm)**

- B = 18.5mm
- A = 12.0mm
- C = 4.0mm

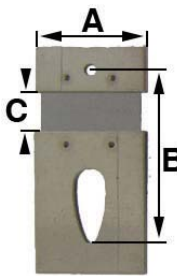

Code	Description	UOM	Price
S5554	B = 18.5mm (A = 12mm & C = 4.0mm)	EACH	£3.25

**B = 18.5mm (A = 12mm & C = 5.0mm)**

- B = 18.5mm
- A = 12.0mm
- C = 5.0mm

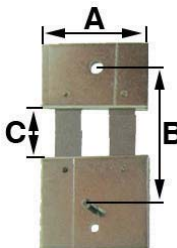

Code	Description	UOM	Price
S5551	B = 18.5mm (A = 12mm & C = 5.0mm)	EACH	£3.55

**B = 19.0mm (A = 4.0mm & C = 11.5mm)**

- B = 19.0mm
- A = 4.0mm
- C = 11.5mm

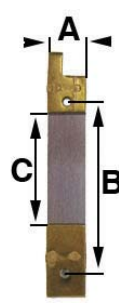

Code	Description	UOM	Price
S5561	B = 19.0mm (A = 4.0mm & C = 11.5mm)	EACH	£4.50

**B = 19.0mm (A = 5.0mm & C = 10mm)**

- B = 19.0mm
- A = 5.0mm
- C = 10.0mm

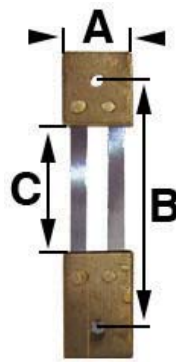

Code	Description	UOM	Price
S5535	B = 19.0mm (A = 5.0mm & C = 10mm)	EACH	£2.75

**B = 19.0mm (A = 8.0mm & C = 3.0mm)**

- B = 19.0mm
- A = 8.0mm
- C = 3.0mm

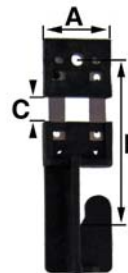

Code	Description	UOM	Price
S33943	B = 19.0mm (A = 8.0mm & C = 3.0mm)	EACH	£8.95

**B = 19.0mm (A = 10mm & C = 8.0mm)**

- B = 19.0mm
- A = 10.0mm
- C = 8.0mm

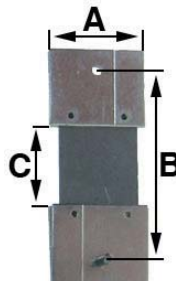

Code	Description	UOM	Price
S33932	B = 19.0mm (A = 10mm & C = 8.0mm)	EACH	£3.95

**by Size: B = 19.5mm to 120mm**



Suspension Springs - B = 19.5mm to 120mm

- Brass & Steel
- High Quality
- For Pendulum Clocks
- German made except where stated

Dimensions: B x A x C

- A = Width
- B = Distance Between Pinning Points
- C = Actual Spring Length

**B = 19.5mm (A = 5.0mm & C = 8.4mm)**

- B = 19.5mm
- A = 5.0mm
- C = 8.4mm

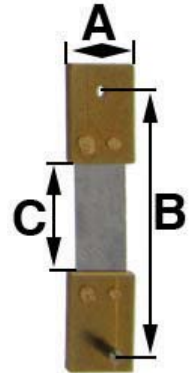

Code	Description	UOM	Price
S5536	B = 19.5mm (A = 5.0mm & C = 8.4mm)	EACH	£3.10

**B = 19.5mm (A = 10mm & C = 8mm)**

- B = 19.5mm
- A = 10.0mm
- C = 8.0mm

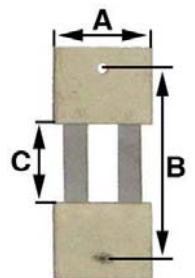

Code	Description	UOM	Price
S33940	B = 19.5mm (A = 10mm & C = 8mm)	EACH	£2.85





**B = 20.0mm (A = 5.0mm & C = 13.0mm)**

- B = 20.0mm
- A = 5.0mm
- C = 13.0mm

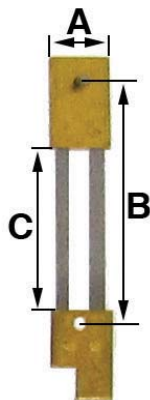

Code	Description	UOM	Price
S5538	B = 20.0mm (A = 5.0mm & C = 13.0mm)	EACH	£3.25

**B = 20.0mm (A = 8.0mm & C = 11.0mm)**

- B = 20.0mm
- A = 8.0mm
- C = 11.0mm

Seth Thomas

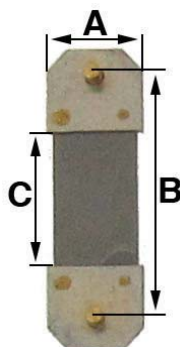

Code	Description	UOM	Price
S33935	B = 20.0mm (A = 8.0mm & C = 11.0mm)	EACH	£3.70

**B = 20.0mm (A = 12mm & C = 4.0mm)**

- B = 20.0mm
- A = 12.0mm
- C = 4.0mm

B = Pin to Top Hole

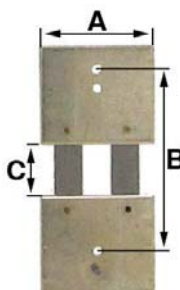

Code	Description	UOM	Price
S5545	B = 20.0mm (A = 12mm & C = 4.0mm)	EACH	£3.65

**B = 21.0mm (A = 14mm & C = 6.9mm)**

- B = 21.0mm
- A = 14.0mm
- C = 6.9mm

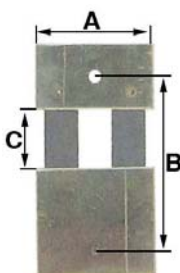

Code	Description	UOM	Price
S5548	B = 21.0mm (A = 14mm & C = 6.9mm)	EACH	£4.85

**B = 21.0mm (A = 17mm & C = 7.5mm)**

- B = 21.0mm
- A = 17.0mm
- C = 7.5mm

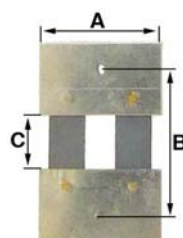

Code	Description	UOM	Price
S5546	B = 21.0mm (A = 17mm & C = 7.5mm)	EACH	£4.85

**B = 22.0mm (A = 12mm & C = 5.0mm)**

- B = 22.0mm
- A = 12.0mm
- C = 5.0mm

B = Pin to Top Hole

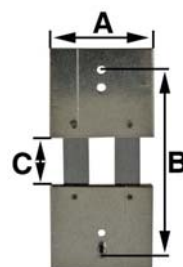

Code	Description	UOM	Price
S5550	B = 22.0mm (A = 12mm & C = 5.0mm)	EACH	£4.85

**B = 23.0mm (A = 6.0mm & C = 13.5mm)**

- B = 23.0mm
- A = 6.0mm
- C = 13.5mm

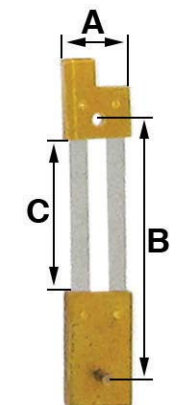

Code	Description	UOM	Price
S5539	B = 23.0mm (A = 6.0mm & C = 13.5mm)	EACH	£3.25

**B = 25.0mm (A = 8.0mm & C = 16.0mm)**

- B = 25.0mm
- A = 8.0mm
- C = 16.0mm

Seth Thomas

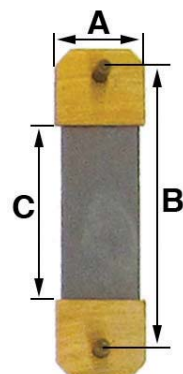

Code	Description	UOM	Price
S33934	B = 25.0mm (A = 8.0mm & C = 16.0mm)	EACH	£5.95

**B = 26.0mm (A = 14mm & C = 7.0mm)**

- B = 26.0mm
- A = 14.0mm
- C = 7.0mm

B = Pin to Top Hole

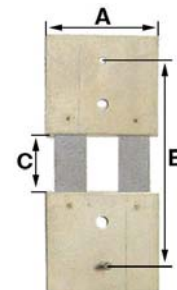

Code	Description	UOM	Price
S5549	B = 26.0mm (A = 14mm & C = 7.0mm)	EACH	£4.85

**B = 27.50mm (A = 12.0mm & C = 14.0mm), Indian**

- B = 27.5mm
- A = 12.0mm
- C = 14.0mm

Fuji

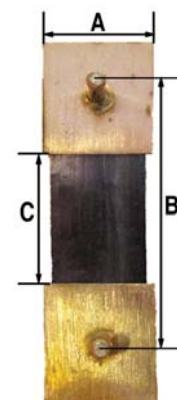

Code	Description	UOM	Price
S31274	B = 27.50mm (A = 12.0mm & C = 14.0mm), Indian	EACH	£1.85

**B = 31.0mm (A = 14mm & C = 36.0mm)**

- B = 31.0mm
- A = 14.0mm
- C = 36.0mm

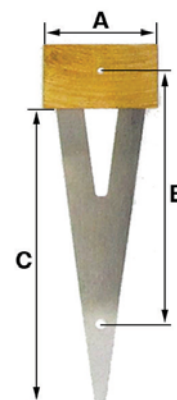

Code	Description	UOM	Price
S33933	B = 31.0mm (A = 14mm & C = 36.0mm)	EACH	£4.85

**B = 32.0mm (A = 11.5mm & C = 6.0mm)**

- B = 32.0mm
- A = 11.5mm
- C = 6.0mm

Urgos

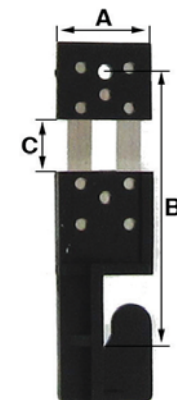

Code	Description	UOM	Price
S33942	B = 32.0mm (A = 11.5mm & C = 6.0mm)	EACH	£7.55



PRICE PROMISE GUARANTEE

**B = 32.5mm (A = 8.0mm & C = 22.0mm)**

- B = 32.5mm
- A = 8.0mm
- C = 22.0mm

Zaans

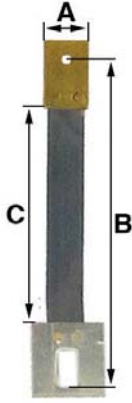

Code	Description	UOM	Price
S33936	B = 32.5mm (A = 8.0mm & C = 22.0mm)	EACH	£6.30

**B = 60.0mm (A = 6.0mm & C = 57.0mm)**

- B = 60.0mm
- A = 6.0mm
- C = 57.0mm

English Dial, Fusee

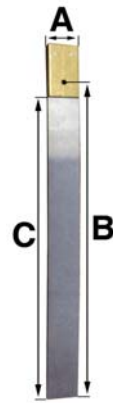

Code	Description	UOM	Price
S5525	B = 60.0mm (A = 6.0mm & C = 57.0mm)	EACH	£2.95

**by Size with Stamped Hole**

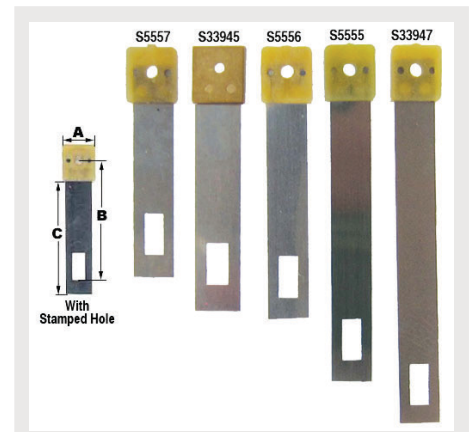

Suspension Springs - B = 19.5mm to 120mm

- With Stamped Hole for Extension
- Brass & Steel
- High Quality
- For Pendulum Clocks

Dimensions: B x A x C

- A = Width
- B = Distance Between Top Pin Point & Extension Attachment
- C = Actual Spring Length

**B = 32.0mm (A = 6.25mm & C = 28.0mm), Indian**

- B = 32.0mm
- A = 6.25mm
- C = 28.0mm

English Dial, Fusee

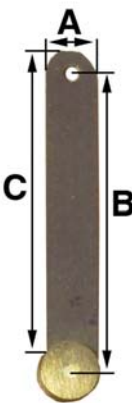

Code	Description	UOM	Price
S30944	B = 32.0mm (A = 6.25mm & C = 28.0mm), Indian	EACH	£1.75

**B = 120mm (A = 6.0mm & C = 110mm)**

- B = 120.0mm
- A = 6.0mm
- C = 110.0mm

English Dial, Fusee

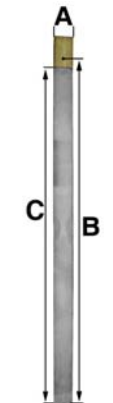

Code	Description	UOM	Price
S33928	B = 120mm (A = 6.0mm & C = 110mm)	EACH	£2.95

**B = 16.0mm (A = 5.0mm & C = 17.5mm)**

- B = 16.0mm
- A = 5.0mm
- C = 17.5mm

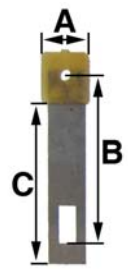

Code	Description	UOM	Price
S5557	B = 16.0mm (A = 5.0mm & C = 17.5mm)	EACH	£2.10

**B = 33.0mm (A = 5.0mm & C = 18.5mm)**

- B = 33.0mm
- A = 5.0mm
- C = 18.5mm

Warmink

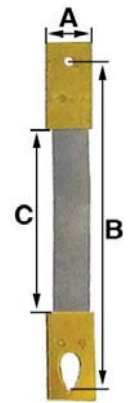

Code	Description	UOM	Price
S33937	B = 33.0mm (A = 5.0mm & C = 18.5mm)	EACH	£4.85

**B = 126mm (A = 10mm & C = 120mm)**

- B = 126.0mm
- A = 10.0mm
- C = 120.0mm

Bornholmer

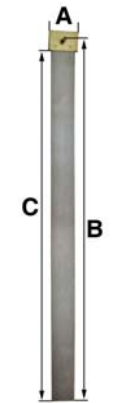

Code	Description	UOM	Price
S33938	B = 126mm (A = 10mm & C = 120mm)	EACH	£5.25

**B = 19.0mm (A = 5.0mm & C = 19.0mm)**

- B = 19.0mm
- A = 5.0mm
- C = 19.0mm

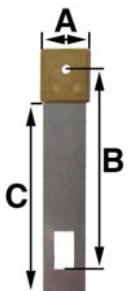

Code	Description	UOM	Price
S33945	B = 19.0mm (A = 5.0mm & C = 19.0mm)	EACH	£2.00

**B = 20.0mm (A = 5.0mm & C = 22.0mm)**

- B = 20.0mm
- A = 5.0mm
- C = 22.0mm

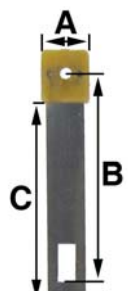

Code	Description	UOM	Price
S5556	B = 20.0mm (A = 5.0mm & C = 22.0mm)	EACH	£2.10



**ORDER tracking**

**SECURE ONLINE ORDERING**



Brass Pins

See Page 1345



WD-40 Lubricating Spray

See Page 1180



**B = 26.5mm (A = 5.0mm & C = 26.0mm)**

- B = 26.5mm
- A = 5.0mm
- C = 26.0mm

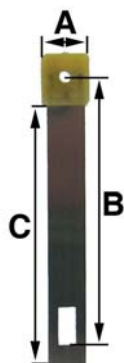

Code	Description	UOM	Price
S5555	B = 26.5mm (A = 5.0mm & C = 26.0mm)	EACH	£2.10

**B = 30.0mm (A = 5.0mm & C = 30.0mm)**

- B = 30.0mm
- A = 5.0mm
- C = 30.0mm

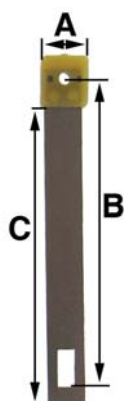

Code	Description	UOM	Price
S33947	B = 30.0mm (A = 5.0mm & C = 30.0mm)	EACH	£2.00

**by Size with Extension**



- Suspension Springs - B = 19.5mm to 120mm
- With Stamped Hole & Extension Ready Assembled
  - Brass & Steel
  - High Quality
  - For Pendulum Clocks

- Dimensions: L x L1 x L2
- L = Overall Length
  - L1 = Distance Between Top Pin Point & Extension Attachment
  - L2 = Distance Between Pin Points

Code	Description	UOM	Price
S33956	L = 45mm (L1 = 16mm & L2 = 29mm)	EACH	£7.95
S33953	L = 49mm (L1 = 19mm & L2 = 30mm)	EACH	£7.95

S33951	L = 49mm (L1 = 26mm & L2 = 23mm)	EACH	£7.95
S33952	L = 54mm (L1 = 19mm & L2 = 35mm)	EACH	£8.25
S33950	L = 60mm (L1 = 26mm & L2 = 34mm)	EACH	£7.95
S33958	L = 79mm (L1 = 26mm & L2 = 54mm)	EACH	£7.95
S33954	L = 88mm (L1 = 26mm & L2 = 62mm)	EACH	£7.95
S33955	L = 107mm (L1 = 30mm & L2 = 77mm)	EACH	£7.95
S33957	L = 115mm (L1 = 26mm & L2 = 89mm)	EACH	£7.95

**Korean**

Suspension Springs - Korean

- Brass & Steel
- 31 Day
- Overall length 310mm



Code	Description	UOM	Price
S32023	Korean Clock Suspension Spring	EACH	£2.30

**Longcase, Double Ended**

**Longcase (2 End) Suspension, Indian**



- Overall Length 137mm
- 27 x 9 x 5mm block approx.
- 98mm Spring Length approx.
- 1/8" Whitworth Thread in Block

Code	Description	UOM	Price
L38420	Longcase (2 End) Suspension, Indian	EACH	£1.75

**Longcase (2 End) with 27mm Block, UK**

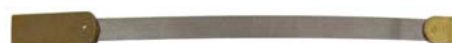

- Overall Lengths 137mm
- 27 x 9 x 5mm block approx.
- 98mm Spring Length approx.
- 1/8" Whitworth Thread in Block
- Made in UK

Code	Description	UOM	Price
L0928	Longcase (2 End) with 27mm Block, UK	EACH	£3.75

Price breaks available, see website

**PRICE PROMISE GUARANTEE**

**TODAY** SAME DAY DISPATCH

**Longcase (2 End) with 76mm Block, UK**



- Overall Lengths 137mm
- 76 x 9 x 5mm block approx.
- 50mm Spring Length approx.
- 1/8" Whitworth Thread in Block
- Made in UK

L34546 is designed with an extended block to help prevent a twist in the pendulum as it swings.

Code	Description	UOM	Price
L34546	Longcase (2 End) with 76mm Block, UK	EACH	£6.95

**Longcase 27mm Block Only, UK**

- Brass
- 1/8" Whitworth Thread in Block
- Made in UK



Code	Description	UOM	Price
L34550	Longcase 27mm Block Only, UK	EACH	£2.55

**Longcase, Single Ended**



Suspension Springs - Longcase Clock - Single Ended

- Long Case Clocks
- Brass (1 Ends)

L38419 Dimensions:

- Overall Length 117mm
- 105mm Spring Length (approximate)
- 6mm width of steel (approximate)

L40139 Dimensions:

- Overall Length 130mm
- 120mm Spring Length (approximate)
- Round End
- 6mm width of steel (approximate)

L0927 Dimensions:

- Overall Length 117mm
- 105mm Spring Length (approximate)
- 6mm width of steel (approximate)

Code	Description	UOM	Price
L38419	Longcase (1 End) Suspension	EACH	£1.25
L40139	Longcase (1 End) Suspension, Round	EACH	£1.20
L0927	Longcase (1 End) Suspension, UK	EACH	£2.60

Price breaks available, see website

**Longcase, Set**



Suspension Springs - Longcase Clock - Set

Set includes:

- 2 end with 30mm block, 145mm overall length
- 1 end, 120mm overall length
- 1 end, round, 130mm overall length

Code	Description	UOM	Price
P39684	L/C Suspension Set	PACK*3	£3.25

Online Discounts

**Suspension Extensions**

- 55mm total length and suspension cramp
- Brass
- With stamped hole
- 3 pieces



Code	Description	UOM	Price
L7791	Suspension Extensions	PACK*3	£9.50

**SUSPENSION SILK**

**Suspension Silk**



- Suspension silk
- For French clocks
- 1 metre
- Ø0.20mm

Code	Description	UOM	Price
S46472	Suspension Silk	EACH	£0.98

**LED & Magnifying Lens Bench Lamp**



See Page: 679

**SUSPENSION STEEL**

**Suspension Spring Steel**

Clock Suspension Springs - Steel Material  
Ideal for mantle clocks and most other pendulum clocks where making a suspension spring is the only answer. A choice of steel suspension spring material in strip, sheet or pre-cut feathers.

- Strips
- Sheets
- Pre-Cut feathers

**Suspension Material, Strips - Made in UK**



- 1 metre length
- Height 6mm
- Thickness 0.15mm approx
- Made in UK

Code	Description	UOM	Price
S13730	Suspension Material, Strips - Made in UK	1 Metre	£3.55

**Spring Steel, Sheets**



- Size 60 x 40mm
- Thicknesses of 0.03 to 0.12mm
- 8 Pieces

Code	Description	UOM	Price
S8589	Spring Steel, Sheets	PACK*8	£50.95

**Spring Steel, Feathers**



- 25 pieces
- Assorted

Code	Description	UOM	Price
S31275	Spring Steel, Feathers	PACK*25	£2.15

**WEIGHTS, SHELLS, HOOKS & RINGS**

**WEIGHTS**

**Brass Shell with Lead Filling**



- Brass shells with lead fillings
- Conical shape
- Natural brass finish (unpolished)
- Handmade
- Dimensions: Weight (width at widest point x height) (approximate)
- Made in Germany

Weights available:

- 250g
- 500g
- 750g
- 900g
- 1200g
- 1450g
- 1800g
- 2500g
- 3200g

Code	Description	UOM	Price
W44895	275g (Ø30 x 115mm) Weight	EACH	£7.35
W44896	500g (Ø30 x 85mm) Weight	EACH	£11.50
W44897	750g (Ø30 x 120mm) Weight	EACH	£16.95
W44898	900g (Ø35 x 95mm) Weight	EACH	£18.75
W44899	1200g (Ø35 x 130mm) Weight	EACH	£22.95
W44900	1450g (Ø35 x 160mm) Weight	EACH	£25.95
W44901	1800g (Ø40 x 160mm) Weight	EACH	£32.95
W44902	2500g (Ø45 x 170mm) Weight	EACH	£38.95
W44903	3200g (Ø45 x 210mm) Weight	EACH	£46.95

**Cuckoo Clock Weights (Mechanical)**

Cuckoo Clock - Weights

Cast iron with bronze varnish finish.

- Sold Singly
- Antique Finish
- Traditional Shape & Colouring
- For traditional mechanical cuckoo clocks

Weights: Overall length x Max Diameter Ø

- 80g: 75mm x Ø20mm
- 150g: 90mm x Ø22mm
- 200g: 105mm x Ø25mm
- 250g: 115mm x Ø25mm



- 275g: 120mm x Ø25mm
- 320g: 125mm x Ø25mm
- 350g: 125mm x Ø30mm
- 375g: 135mm x Ø30mm
- 420g: 135mm x Ø30mm
- 500g: 140mm x Ø30mm
- 630g: 170mm x Ø33mm
- 750g: 170mm x Ø35mm
- 875g: 170mm x Ø40mm
- 1000g: 190mm x Ø40mm
- 1260g: 175mm x Ø45mm
- 1500g: 190mm x Ø45mm
- 1750g: 220mm x Ø45mm

Code	Description	UOM	Price
W43329	80g Cuckoo Weight	EACH	£3.00
W43330	150g Cuckoo Weight	EACH	£3.50
W43331	200g Cuckoo Weight	EACH	£4.75
W43332	250g Cuckoo Weight	EACH	£2.30
W1841	275g Cuckoo Weight	EACH	£2.40
W1842	320g Cuckoo Weight	EACH	£2.95
W43333	350g Cuckoo Weight	EACH	£3.95
W1843	375g Cuckoo Weight	EACH	£4.75
W43334	420g Cuckoo Weight	EACH	£3.95
W1844	500g Cuckoo Weight	EACH	£5.95
W43335	630g Cuckoo Weight	EACH	£6.50
W1845	750g Cuckoo Weight	EACH	£7.95
W43336	875g Cuckoo Weight	EACH	£8.45
W1846	1000g Cuckoo Weight	EACH	£11.40
W1847	1260g Cuckoo Weight	EACH	£11.50
W1848	1500g Cuckoo Weight	EACH	£13.75
W43337	1750g Cuckoo Weight	EACH	£16.75

**Cuckoo Clock Weights (Quartz)**



Cuckoo Clock - Weights

- For quarts clocks
- Plastic or wooden
- Different styles
- Sold in pairs
- Antique Finish
- Traditional Shape & Colouring

Dimensions:

- Material, overall length x diameter Ø

Code	Description	UOM	Price
W47668	Plastic, 100 x Ø30mm	PAIR	£2.50
W47669	Plastic, 150 x Ø50mm	PAIR	£2.50
W47666	Wooden, 150 x Ø35mm	PAIR	£2.95
W47667	Wooden, 150 x Ø40mm	PAIR	£2.95

**Dutch Clock Weights**

Dutch Clock Weight

- Brass
- Highly Polished
- Weight: 1000g
- Diameter: Ø60mm
- Height: 100mm



Code	Description	UOM	Price
W7854	Dutch Clock Weight	EACH	£36.95
Price breaks available, see website			

**Hermle Weights, Iron**

Hermle Weights - Iron

Dimensions: Diameter x Overall Length x Weight



- Ø39mm x 235mm x 2.0Kg (E005.02700)
- Ø39mm x 245mm x 2.5kg (E005.02580)
- Ø45mm x 225mm x 2.89Kg (E005.14930)
- Ø48mm x 245mm x 3.5Kg (E005.02592)
- Ø58mm x 240mm x 4.5Kg (E005.02602)

For Hermle calibre information see website more info

Code	Description	UOM	Price
HERE00502700	Ø39mm x 235mm x 2.0Kg (E005.02700)	PACK*2	£35.95
W46182	Ø39mm x 245mm x 2.5kg (E005.02580)	EACH	£21.95
HERE00514930	Ø45mm x 225mm x 2.89Kg (E005.14930)	EACH	£37.95
H38196	Ø48mm x 245mm x 3.5Kg (E005.02592)	EACH	£38.95
H38197	Ø58mm x 240mm x 4.5Kg (E005.02602)	EACH	£39.95

**Hermle Weights, Lead**

Hermle Weights - Lead

Dimensions: Diameter x Overall Length x Weight



- Ø37mm x 260mm x 3.30Kg (E030.02280)
- Ø45mm x 227mm x 2.89Kg (E030.01870)
- Ø47mm x 140mm x 2.75kg (E030.04070)
- Ø47mm x 180mm x 3.60kg (E030.02770)
- Ø57mm x 275mm x 8.40kg (E030.03980)

Code	Description	UOM	Price
H38202	Ø37mm x 260mm x 3.30Kg (E030.02280)	EACH	£49.95
H38222	Ø45mm x 227mm x 2.89Kg (E030.01870)	EACH	£52.95
H42143	Ø47mm x 140mm x 2.75kg (E030.04070)	EACH	£49.95
W46180	Ø47mm x 180mm x 3.60kg (E030.02770)	EACH	£55.95
W46183	Ø57mm x 275mm x 8.40kg (E030.03980)	EACH	£99.95

**Longcase Weights & Shells, Brass**



Longcase Clock - Brass - Weights & Shells

- Ø64mm
- Overall Height 200mm
- Dimensions are Approximate
- Made in UK

Available:

- Finished Polished Brass Case, Filled
- Finished Polished Brass Case, Unfilled
- Unfinished Brass unfilled Case

Dimensions:

- (weight, diameter Ø x overall length)

Code	Description	UOM	Price
L34527	Weight & Shell (12lb, Ø64 x 200mm) Polished	12LB	£74.95
L34528	Shell (Ø64 x 200mm), Polished	EACH	£58.30
L34529	Shell (Ø64 x 200mm), Unfinished	EACH	£51.45

**Longcase Weights, Cast Iron**

Longcase Clock - Cast Iron - Weights

Cast with an attractive decorative profiled top and radius bottom and parallel sides.



Cast Solid Iron Weight

- Weighing 8lb (3.63kg), Ø68 x 180mm (diameter x overall length)
- Weighing 12lb (5.45kg), Ø68 x 250mm (diameter x overall length)

Made in UK

Code	Description	UOM	Price
L34526	8lb (30 Hour), Ø68 x 180mm Cast Iron	8LB	£30.95
L34525	12lb (8 Day), Ø68 x 250mm Cast Iron	12LB	£41.95

**Longcase Weights, Lead**

Long Case Clock - Cast Lead - Weights

Cast with an attractive radius top and bottom and tapered sides.



Traditionally used for long case 30 Hour (7.5lb) and 8 day (10lb & 12lb) clocks of many styles and periods, the weight includes a steel hook to hang the weight straight off the pulley stirrup.

Cast solid lead weight

- Weighing 7.5lb (3.40kg) - 30 hour
- Weighing 10lb (4.54kg) - 8 Day
- Weighing 12lb (5.45kg) - 8 Day

Dimensions:

- Weight (width at widest point x height) (approximate)

Made in UK

Code	Description	UOM	Price
W8564	7.5lb (Ø55 x 130mm) Lead Weight (30 Hour)	EACH	£34.50
W8563	10lb (Ø55 x 165mm) Lead Weight (8 day)	EACH	£37.95
W8562	12lb (Ø55 x 200mm) Lead Weight (8 day)	EACH	£42.95

**Longcase Weights, Lead Counterweight**

Long Case Clock - Lead Counterweight

- Lead
- Counterweight or doughnut
- For 30 hour clocks
- Ø44mm x 11mm (approx.)
- 125g (approx.)



Code	Description	UOM	Price
L38761	Long Case Lead Counterweight, Indian	EACH	£2.75
L0918	Long Case Lead Counterweight, UK	EACH	£3.95

**Vienna Regulator Clock Weights**

Vienna Regulator Clock - Weights - Filled

- Vienna Weight with Hook
- Highly Polished
- Solid Brass Case
- Lead Filled
- Threaded Hook
- Made in UK

Dimensions:  
• Dimensions: Weight (width at widest point x height) (approximate)



Code	Description	UOM	Price
<b>W6233</b>	1.25Kg (Ø40 x 95mm) Vienna Weight	EACH	<b>£47.50</b>

**Universal Weights for Shells**

Universal Weights

- Universal weights
- For use with weight shells
- Can be used on their own
- With threaded hole for brass weight hook
- Iron
- Made in China

Dimensions:  
• Weight, Diameter x length

The threaded hole may be slightly off centre so please ensure that a sufficiently large weight shell is used for each weight



Code	Description	UOM	Price
<b>W46028</b>	2Kg, Ø35 x 235mm Weight	EACH	<b>£17.95</b>
<b>W46027</b>	2.5Kg, Ø40 x 220mm Weight	EACH	<b>£19.95</b>
<b>W46029</b>	3Kg, Ø45 x 225mm Weight	EACH	<b>£21.95</b>
<b>W46030</b>	3.5Kg, Ø45 x 245mm Weight	EACH	<b>£23.95</b>
<b>W46031</b>	4Kg, Ø50 x 245mm Weight	EACH	<b>£25.95</b>

**Universal Weights, Style 1**



- Universal clock weights
- Cast iron
- Dimensions: Weight (width at widest point x height) (approximate)
- Made in Germany

Weights available:  
• 130g  
• 160g  
• 600g  
• 900g  
• 1200g

Code	Description	UOM	Price
<b>W44860</b>	130g (Ø25 x 65mm) Weight	EACH	<b>£3.30</b>

<b>W44861</b>	160g (Ø25 x 68mm) Weight	EACH	<b>£5.50</b>
<b>W44862</b>	600g (Ø40 x 100mm) Weight	EACH	<b>£6.50</b>
<b>W44863</b>	900g (Ø38 x 135mm) Weight	EACH	<b>£9.95</b>
<b>W44864</b>	1200g (Ø45 x 160mm) Weight	EACH	<b>£13.95</b>

**Universal Weights, Style 2**

- Universal clock weights
- Cast iron
- Grooved
- Dimensions: Weight (width at widest point x height) (approximate)
- Made in Germany

Weights available:  
• 500g  
• 750g



Code	Description	UOM	Price
<b>W44866</b>	500g (Ø30 x 140mm) Weight	EACH	<b>£6.95</b>
<b>W44867</b>	750g (Ø30 x 170mm) Weight	EACH	<b>£9.35</b>

**Universal Weights, Style 3**

- Universal clock weights
- Cast iron
- 6 sided
- Dimensions: Weight (width at widest point x height) (approximate)
- Made in Germany

Weights available:  
• 750g



Code	Description	UOM	Price
<b>W44868</b>	750g (Ø32 x 180mm) Weight	EACH	<b>£9.35</b>

**Universal Weights, Style 4**

- Universal clock weights
- Cast iron
- 6 sided
- Dimensions: Weight (width at widest point x height) (approximate)
- Made in Germany

Weights available:  
• 750g  
• 1000g



Code	Description	UOM	Price
<b>W44877</b>	750g (Ø35 x 160mm) Weight	EACH	<b>£8.95</b>
<b>W44878</b>	1000g (Ø35 x 185mm) Weight	EACH	<b>£12.45</b>



**Universal Weights, Style 5**



- Universal clock weights
- Cast iron
- Dimensions: Weight (width at widest point x height) (approximate)
- Made in Germany

Weights available:  
• 2200g  
• 2500g  
• 3400g

Code	Description	UOM	Price
<b>W44879</b>	2200g (Ø40 x 235mm) Weight	EACH	<b>£25.95</b>
<b>W44880</b>	2500g (Ø45 x 235mm) Weight	EACH	<b>£29.95</b>
<b>W44881</b>	3400g (Ø55 x 255mm) Weight	EACH	<b>£39.95</b>

**Universal Weights, Style 6**

- Universal clock weights
- Cast iron
- Dimensions: Weight (width at widest point x height) (approximate)
- Made in Germany

Weights available:  
• 1260g



Code	Description	UOM	Price
<b>W44884</b>	1260g (Ø35 x 185mm) Weight	EACH	<b>£14.95</b>

**Universal Weights, Style 7**

- Universal clock weights
- Cast iron
- Dimensions: Weight (width at widest point x height) (approximate)
- Made in Germany

Weights available:  
• 250g



Code	Description	UOM	Price
<b>W44883</b>	250g (Ø25 x 105mm) Weight	EACH	<b>£3.95</b>

**Universal Weights, Style 8**

- Universal clock weights
- Cast iron
- Dimensions: Weight (width at widest point x height) (approximate)
- Made in Germany

Weights available:  
• 1500g



Code	Description	UOM	Price
W44885	1500g (Ø40 x 205mm) Weight	EACH	£17.95

**Universal Weights, Style 9**

- Universal clock weights
- Cast iron
- Dimensions: Weight (width at widest point x height) (approximate)
- Made in Germany

Weights available:  
• 1000g  
• 2000g  
• 3000g



Code	Description	UOM	Price
W44886	1000g (Ø35 x 210mm) Weight	EACH	£11.95
W44887	2000g (Ø50 x 215mm) Weight	EACH	£23.95
W44888	3000g (Ø55 x 260mm) Weight	EACH	£34.95

**Universal Weights, Style 10**

- Universal clock weights
- Cast iron
- Dimensions: Weight (width at widest point x height) (approximate)
- Made in Germany

Weights available:  
• 800g  
• 1000g  
• 2000g



Code	Description	UOM	Price
W44890	1000g (Ø32 x 180mm) Weight	EACH	£11.95
W44891	2000g (Ø42 x 200mm) Weight	EACH	£23.95

**Universal Weights, Style 11**

- Universal clock weights
- Cast iron
- Dimensions: Weight (width at widest point x height) (approximate)
- Made in Germany

Weights available:  
• 1200g



Code	Description	UOM	Price
W44892	1200g (Ø34 x 215mm) Weight	EACH	£14.95

**Universal Weights, Style 12**

- Universal clock weights
- Cast iron
- Dimensions: Weight (width at widest point x height) (approximate)
- Made in Germany

Weights available:  
• 1300g



Code	Description	UOM	Price
W44893	1300g (Ø40 x 190mm) Weight	EACH	£15.50

**Universal Weights, Style 13**

- Universal clock weights
- Cast iron
- Dimensions: Weight (width at widest point x height) (approximate)
- Made in Germany

Weights available:  
• 1500g



Code	Description	UOM	Price
W44894	1500g (Ø45 x 165mm) Weight	EACH	£17.50

**Universal Weights, Style 15**

- Universal clock weights
- Cast iron
- Ornamental weight
- Dimensions: Weight (width at widest point x height) (approximate)
- Made in Germany

Weights available:  
• 1300g



Code	Description	UOM	Price
W44870	1300g (Ø45 x 210mm) Weight	EACH	£14.95

**Universal Weights, Style 16**



• Universal clock weights

- Cast iron
- Ball weight
- Dimensions: Weight (Diameter)
- Made in Germany

Weights available:  
• 230g  
• 1000g

Code	Description	UOM	Price
W44872	230g (Ø40mm) Weight	EACH	£4.95
W44871	1000g (Ø70mm) Weight	EACH	£22.50

**Universal Weights, Style 16**

- Universal clock weights
- Cast iron
- Dimensions: Weight (width at widest point x height) (approximate)
- Made in Germany

Weights available:  
• 4700g



Code	Description	UOM	Price
W44874	4700g (Ø70 x 220mm) Weight	EACH	£55.95

**Universal Weights, Style 17**

- Universal clock weights
- Cast iron
- Dimensions: Weight (width at widest point x height) (approximate)
- Made in Germany

Weights available:  
• 3900g



Code	Description	UOM	Price
W44875	3900g (Ø60 x 220mm) Weight	EACH	£45.95

**Universal Weights, Style 18**

- Universal clock weights
- Cast iron
- Comtoise morbier weight
- Dimensions: Weight (width at widest point x height) (approximate)
- Made in Germany

Weights available:  
• 4200g



Code	Description	UOM	Price
W44876	4200g (Ø70 x 230mm) Weight	EACH	£32.95

## WEIGHT SHELLS (MECHANICAL)

### Weight Shells, Hermle

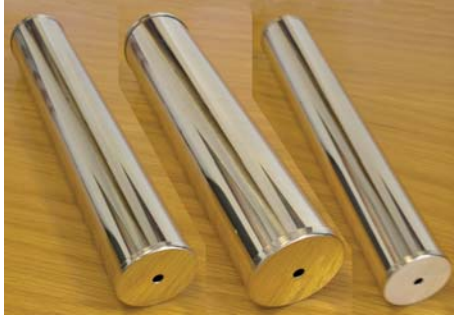

Hermle Weight Shells

Dimensions: Outer Diameter x Inner Diameter x Overall length (includes end caps);

- E030.00970: Ø40mm x Ø39mm x 235mm (Satin)
- B030.809704: Ø40mm x Ø39mm x 235mm (=E030.00970 Polished)
- B030.822704: Ø40mm x Ø39mm x 265mm (=E029.02270)
- B030.840704: Ø50mm x Ø49mm x 140mm
- B030.840804: Ø50mm x Ø49mm x 235mm
- B030.825604: Ø60mm x Ø59mm x 245mm (=E029.02560)
- B030.827504: Ø50mm x Ø49mm x 180mm
- B030.839904: Ø60mm x Ø59mm x 278mm

For Hermle calibre and weight information see website more info

Code	Description	UOM	Price
H29423	Ø40mm x Ø39mm x 235mm (E030.00970) (Satin)	EACH	£24.95
H46184	Ø40mm x Ø39mm x 235mm (B030.809704)	EACH	£24.95
H38201	Ø40mm x Ø39mm x 265mm (B030.822704)	EACH	£24.95
H42142	Ø50mm x Ø49mm x 235mm (B030.840704)	EACH	£24.95
H46181	Ø50mm x Ø49mm x 180mm (B030.827504)	EACH	£24.95
H42149	Ø50mm x Ø49mm x 235mm (B030.840804)	EACH	£24.95
H38198	Ø60mm x Ø59mm x 245mm (B030.825604)	EACH	£24.95
H46185	Ø60mm x Ø59mm x 278mm (B030.839904)	EACH	£24.95

### Weight Shells, (Brass)

Weight Shells - Made in Germany

- Universal
- Brass weight shells
- Polished brass
- Can be shortened to required length
- Supplied with end caps
- Size given is the outer diameter
- Made in Germany



Dimensions: Outside diameter x length

Code	Description	UOM	Price
S43338	Ø40 x 232mm Weight Shell	EACH	£19.95
S43339	Ø50 x 245mm Weight Shell	EACH	£19.95

### Weight Shells (Brass Finish)

Weight Shells

- Universal
- Brass Finish weight shells
- Polished finish
- Complete with threaded centre rod, two end caps, top hook & bottom nib
- Can be shortened to required length
- Size given is the outer diameter
- Stainless steel, titanium plated



Dimensions: Outside diameter x length

Code	Description	UOM	Price
W47605	Ø38 x 235mm Weight Shell	EACH	£13.95
W46023	Ø48 x 225mm Weight Shell	EACH	£16.95
W46024	Ø48 x 280mm Weight Shell	EACH	£16.95
W46022	Ø51 x 245mm Weight Shell	EACH	£16.95
W46020	Ø60 x 245mm Weight Shell	EACH	£16.95
W46021	Ø60 x 280mm Weight Shell	EACH	£16.95

### Weight Shells (Brass Finish), Banded

Weight Shells

- Universal
- Brass finish weight shells
- Polished finish with decorative band
- Complete with threaded centre rod, two end caps, top hook & bottom nib
- Can be shortened to required length
- Size given is the outer diameter
- Stainless steel, titanium plated



Dimensions: Outside diameter x length

See website additional images for pattern close up

Code	Description	UOM	Price
W47603	Ø60 x 245mm Weight Shell	EACH	£18.95
W47604	Ø60 x 280mm Weight Shell	EACH	£19.95

### Weight Shells (Brass Finish), Ornate

Weight Shells

- Universal
- Brass Finish weight shells
- Polished finish with ornate etching
- Complete with threaded centre rod, two end caps, top hook & bottom nib
- Can be shortened to required length
- Size given is the outer diameter
- Stainless steel, titanium plated



Dimensions: Outside diameter x length

See website additional images for pattern close up

Code	Description	UOM	Price
W46026	Ø48 x 280mm Weight Shell	EACH	£18.95
W46025	Ø60 x 245mm Weight Shell	EACH	£18.95

### Weight Shells (Silver Finish), Polished

Weight Shells

- Universal
- Silver finish weight shells
- Polished finish
- Complete with threaded centre rod, two end caps, top hook & bottom nib
- Can be shortened to required length
- Size given is the outer diameter
- Stainless steel, titanium plated



Dimensions: Outside diameter x length

Code	Description	UOM	Price
W47613	Ø48 x 225mm Weight Shell	EACH	£16.95
W47614	Ø48 x 280mm Weight Shell	EACH	£16.95
W47615	Ø51 x 245mm Weight Shell	EACH	£16.95
W47616	Ø60 x 245mm Weight Shell	EACH	£17.95
W47617	Ø60 x 280mm Weight Shell	EACH	£17.95

## WEIGHT SHELLS (MECHANICAL) END CAPS

### Weight Shell Caps



Weight Shell Caps

- Size given is the diameter of the weight shell that the caps fits
- Supplied in pairs
- Brass colour
- Titanium plated stainless steel

Code	Description	UOM	Price
W46074	Ø38mm Weight Shell End Cap	PAIR	£1.95
W46073	Ø48mm Weight Shell End Cap	PAIR	£1.95
W46072	Ø51mm Weight Shell End Cap	PAIR	£1.95
W46071	Ø60mm Weight Shell End Cap	PAIR	£1.95

### Weight Shell Caps, Hermle

Hermle Weight Shell Caps

Dimensions: Inner Ø x (Outer Ø)

HERE030043704

- For weight shells our codes HERE03000970 & H38201
- Hermle E030-043704



H29182

- For weight shells our codes H42142 & H42149
- Hermle E030-043304

H29183

- For weight shells our codes H38198
- Hermle E030.042304

Code	Description	UOM	Price
HERE030043704	Ø40mm (Ø41mm) Weight Shell Cap	EACH	£4.50
H29182	Ø50mm (Ø51mm) Weight Shell Cap	EACH	£5.95
H29183	Ø60mm (Ø61mm) Weight Shell Cap	EACH	£5.95



ORDER tracking



TRADE SUPPLIER



## WEIGHT SHELLS (MECHANICAL) EXTENSION PIECE

### Weight Extension Piece

Hermle Weight Extension Piece

E005.04720:

- Hermle 1151 series
- 41mm overall length

Screws into the weight allowing the weight screw eye to connect to a shorter weight, through the shell cap (see additional images)



Code	Description	UOM	Price
H38204	E005.04720 Hermle Weight Extension Piece	EACH	£2.95

## WEIGHT SHELLS (MECHANICAL) HOOKS & RINGS

### S Hooks

22

Long Case Clock - S Hook

Longcase Steel S Hook or weight hook, used for hanging weights from Longcase pulleys. Strong traditional steel "S" for weights etc.

- 30mm Height
- 20mm Width



Code	Description	UOM	Price
L38764	Long Case S Hook, Indian	EACH	£0.40
L0925	Long Case S Hook	EACH	£0.95

### Weight Hook

Long Case Clock - Weight Hook

- Steel
- Ø4.75mm thread
- 18mm thread length (approx.)
- 48mm overall length
- Made in UK



Code	Description	UOM	Price
L0929	Long Case Clock Weight Hook	EACH	£1.50

### Weight Shell Hooks

#### Ø5.00mm Thread (Closed End) Weight Hook

- Thread Ø5.00mm
- Overall Length 24mm
- Brass



Code	Description	UOM	Price
C22831	Ø5.00mm Thread (Closed End) Weight Hook	EACH	£1.25

#### Ø5.00mm Thread (Open End) Weight Hook, UK

- Thread Ø5.00mm
- Overall Length 24mm
- Brass
- Made in Great Britain



Code	Description	UOM	Price
E5222	Ø5.00mm Thread (Open End) Weight Hook, UK	EACH	£4.20

#### Ø6.00mm Thread (Open End) Weight Hook & Shell Screw

- Thread Ø6.00mm
- Overall Length 25mm
- Aluminium
- Brass colour
- Includes weight shell bottom screw



Code	Description	UOM	Price
H47688	Ø6.00mm Thread (Open End) Weight Hook & Shell Screw	EACH	£1.95

### Weight Shell Hooks, Hermle

E007.03160: Hermle Weight Shell Hooks

- Hermle 241 (42), 241.030 (42), 241.033 (42)
- Hermle 261.030 (37), 261.080A (37)
- Hermle 271.081 (?)
- Hermle 451.050 (64), 451.053 (64), 451.053H (64)
- Hermle 461.050 (63)
- Hermle 1151.050 (66)
- Hermle 1161.050 (64)



- E007.03170: Hermle Weight Shell Screw
- Hermle 241 (43), 241.030 (43), 241.033 (43)
- Hermle 261.030 (38), 261.080A (38)
- Hermle 271.081 (?)
- Hermle 451.050 (63), 451.053 (63), 451.053H (63)

- Hermle 461.050 (63)
- Hermle 1151.050 (67)
- Hermle 1161.050 (65)

E007.05220: Hermle Weight Shell Eyelet

- Hermle 451.050 (64)
- Hermle 461.050 (64)
- Hermle 1150.050 (?)
- Hermle 1151.050 (68)
- Hermle 1161.050 (66)

Calibre x (Hermle PDF Part Number)

Code	Description	UOM	Price
HERE00703160	E007.03160 Hermle Weight Shell Hook	EACH	£3.00
HERE00703170	E007.03170 Hermle Weight Shell Screw	EACH	£3.00
HERE00705220	E007.05220 Hermle Weight Shell Eyelet	EACH	£3.00

Price breaks available, see website

### Weight & Chain Hooks & Rings

#### Chain Ends Pull Tabs



- Brass
- Popular style for weight driven clocks
- Contains: 5 chain ends

Code	Description	UOM	Price
C22832	Chain Ends Pull Tabs	PACK*5	£2.95

#### Chain Hooks



- Brass
- Popular style for weight driven clocks
- Contains: 5 pieces

Code	Description	UOM	Price
C22833	Chain Hooks	PACK*5	£2.95

### Chain Hooks & Rings, Bergeon



- Bergeon 10202
- Brass
- Popular style for weight driven clocks
- Contains: 10 each of hooks & rings (20 pieces)

Code	Description	UOM	Price
A4674	Chain Hooks & Rings, Bergeon	PACK*20	£17.95

PRICE PROMISE  
GUARANTEE

SAME DAY DISPATCH

**Chain Hooks & Rings**



- Brass
- Popular style for weight driven clocks
- Contains: 16 each of hooks & rings

Code	Description	UOM	Price
<b>H0861</b>	Chain Hooks & Rings	PACK*32	<b>£7.65</b>

**Chain Hook & Stop (Single Hole)**

- Chain & stop
- Stop overall length 25mm
- Hook overall length 17mm
- Brass finish aluminium
- Stop has two holes



Code	Description	UOM	Price
<b>H46062</b>	Chain Hook & Stop (Single Hole)	PAIR	<b>£0.50</b>
Price breaks available, see website			

**Chain Hook & Stop (Single Hole), Brass**

- Chain & stop
- Stop overall length 25mm
- Hook overall length 25mm
- Solid brass
- Stop has one hole



Code	Description	UOM	Price
<b>H46064</b>	Chain Hook & Stop (Single Hole), Brass	PAIR	<b>£1.50</b>
Price breaks available, see website			

**Hooks, Rings & Chain Ends**

- Brass
- Popular style for weight driven clocks
- Contains: 3 each of hooks, rings & chain ends



Code	Description	UOM	Price
<b>H0860</b>	Hooks, Rings & Chain Ends	PACK*9	<b>£9.85</b>

**Chain Rings**

- Brass
- Popular style for weight driven clocks
- Contains: 5 pieces



Code	Description	UOM	Price
<b>C32431</b>	Chain Rings	PACK*5	<b>£2.95</b>

**Weight & Chain Hooks & Rings, Hermle**



E002.03340: Hermle Chain Eyes (Kettennose):

- Hermle 451.030 (-)
- Hermle 451.050 (45)
- Hermle 461.050 (46)
- Hermle 1151.050 (48)
- Hermle 1161.050 (48)

E002.02250: Hermle Chain Hooks (Kettenhaken):

- Hermle 451.050 (44)
- Hermle 1151.050 (47)

E002.03350: Hermle Chain Pulls / End Loops (Kettenplattchen):

- Hermle 451.050 (46)
- Hermle 1151.050 (49)

E002.01720: Hermle Chain Stop Rings (Kettenring):

- Hermle 451.030 (-)
- Hermle 451.050 (43)

E220.02670: Hermle Chain Stop Rings (Kettenring)

- Hermle 461.050 (81)
- Hermle 1151.050 (46)
- Hermle 1161.050 (81)

Calibre x (Hermle PDF Part Number)

Code	Description	UOM	Price
<b>HERE00201720</b>	E002.01720 Hermle Chain Stop Ring	EACH	<b>£1.65</b>
<b>HERE00202250</b>	E002.02250 Hermle Chain Hook	EACH	<b>£1.65</b>
<b>H28232</b>	E220.02670 Hermle Chain Stop Ring	EACH	<b>£1.65</b>
<b>H28231</b>	E002.03340 Hermle Chain Eye	EACH	<b>£1.65</b>
<b>HERE00203350</b>	E002.03350 Hermle Chain End Loop / Pull	EACH	<b>£1.65</b>
Price breaks available, see website			

**WEIGHT SHELLS (QUARTZ)**

**Weight Shells (Brass Colour)**

Weight Shells

- Universal for quartz clocks
- Brass colour weight shells
- Polished finish
- Complete with threaded centre rod, two end caps, top hook & bottom nib
- Can be shortened to required length
- Size given is the outer diameter
- No weight filling required
- Made from aluminium



Dimensions: Outside diameter x length

Code	Description	UOM	Price
<b>W47607</b>	Ø32 x 103mm Weight Shell	EACH	<b>£4.95</b>
<b>W47610</b>	Ø42 x 190mm Weight Shell	EACH	<b>£6.95</b>

**Clock Chain (Decorative for Quartz Clocks)**

**See Page 1225**

**Weight Shells (Brass Colour), Ornate**

Weight Shells

- Universal for quartz clocks
- Brass colour weight shells
- Polished finish with ornate etching
- Complete with threaded centre rod, two end caps, top hook & bottom nib
- Can be shortened to required length
- Size given is the outer diameter
- No weight filling required
- Made from aluminium



Dimensions: Outside diameter x length

Code	Description	UOM	Price
<b>W47608</b>	Ø32 x 175mm Weight Shell	EACH	<b>£5.50</b>
<b>W47611</b>	Ø42 x 190mm Weight Shell	EACH	<b>£6.95</b>
<b>W47612</b>	Ø50 x 225mm Weight Shell	EACH	<b>£9.95</b>

**Weight Shells (Brass Colour), Ridged**

Weight Shells

- Universal for quartz clocks
- Brass colour weight shells
- Polished finish with fine horizontal ridges
- Complete with threaded centre rod, two end caps, top hook & bottom nib
- Can be shortened to required length
- Size given is the outer diameter
- No weight filling required
- Made from aluminium



Dimensions: Outside diameter x length

Code	Description	UOM	Price
<b>W47606</b>	Ø25 x 150mm Weight Shell	EACH	<b>£4.50</b>
<b>W48081</b>	Ø32 x 105mm Weight Shell	EACH	<b>£5.95</b>
<b>W47609</b>	Ø42 x 195mm Weight Shell	EACH	<b>£6.95</b>

**WEIGHT SHELLS (QUARTZ) END CAPS**

**Weight Shell Caps**



Weight Shell Caps

- Universal for quartz clock weight shells
- Size given is the diameter of the weight shell that the caps fits
- Supplied in pairs
- Brass colour
- Made from aluminium

Code	Description	UOM	Price
<b>W48932</b>	Ø25mm Weight Shell End Cap	PAIR	<b>£1.95</b>
<b>W47664</b>	Ø32mm Weight Shell End Cap	PAIR	<b>£1.95</b>
<b>W47665</b>	Ø40mm Weight Shell End Cap	PAIR	<b>£1.95</b>
<b>W47663</b>	Ø42mm Weight Shell End Cap	PAIR	<b>£1.95</b>
<b>W47662</b>	Ø50mm Weight Shell End Cap	PAIR	<b>£1.95</b>
<b>W47661</b>	Ø57mm Weight Shell End Cap	PAIR	<b>£1.95</b>
<b>W47660</b>	Ø60mm Weight Shell End Cap	PAIR	<b>£1.95</b>

## WEIGHT SHELLS (QUARTZ) HOOKS & NIBS

### Weight Shell Hook & Nibs



#### Weight Shell Hook & Nibs

- Aluminium or brass
- Brass coloured
- Hook & Nib
- For used with our quartz clock weight shells and centre rods
- Open or closed hook, they can be adapted to suit your requirements
- Size given is the thread

#### Hook/nib to centre rod:

- H47689 can be used with rods W47691 & W47692
- H47690 can be used with rod W47693

Code	Description	UOM	Price
H47689	Ø2.50mm Thread Hook & Nib	PAIR	£0.75
H47690	Ø3.00mm Thread Hook & Nib	PAIR	£0.75
C48936	Ø3.00mm Thread Hook & Nib, Brass	PAIR	£0.95

Price breaks available, see website

## WEIGHT SHELLS (QUARTZ) THREADED CENTRE RODS

### Weight Shell Threaded Centre Rods



#### Weight Shell Threaded Centre Rods

- For quartz clocks with decorative weight shells
- Centre rod is used to fix the weight hook and bottom nib
- Threaded each end, smooth middle
- For use with our quartz weight shells, hooks & nibs

#### Rod to hook/nib:

- W47691 can be used with our hook and nib H47690
- W47692 can be used with our hook and nib H47689
- W47693 can be used with our hook and nib H47689

#### Dimensions:

- Thread x overall length (including thread)

Code	Description	UOM	Price
W47692	Ø2.50mm x 160mm Rod	PACK*5	£2.95
W47691	Ø2.50mm x 200mm Rod	PACK*5	£2.95
W47693	Ø3.00mm x 235mm Rod	PACK*5	£2.95



## WIRE COILS

### Brass Wire Coils



#### Wire Brass Coils - Assorted Diameters

Popular with clock makers as spares & jewellery finding repairs when the spring wire breaks in parrot and lobster clasps, findings and bracelets.

- For general forming and multi-purposes on repairs
- Tension wire for clocks
- Diameters: Ø0.40mm to Ø1.20mm
- Pack\*10

Code	Description	UOM	Price
W39683	Brass Wire Coils	PACK*10	£5.95

### Steel Wire Coils



#### Wire Steel Coils - Assorted Diameters

Popular with clock makers as spares & jewellery finding repairs when the spring wire breaks in parrot and lobster clasps, findings and bracelets

- For general forming and multi-purposes on repairs
- Tension wire for clocks
- Diameters: Ø0.30mm to Ø1.00mm
- 8 sizes
- Made in Germany

Code	Description	UOM	Price
W7869	Steel Wire Coils	PACK*8	£24.50

### Wire Guillotine Cutters

See Page 833



### Binding Wire

See Page 1010



## Clock Cleaning, Rinsing & Lubricating Fluid



Ref: F2792



Ref: F2794



Ref: F47529

See Page: 1162